



Variable Speed Drives Catalogue

Reliable made affordable





About Himel

Himel is a multinational manufacturer and provider of electrical products successfully combining global expertise with local knowledge.

Founded by a Spanish entrepreneur in 1958, the company pioneered in exporting quality electrical enclosures, establishing Himel brand globally. Today, our global footprint and technology enable us to provide the best combination of affordable and reliable offers for Low Voltage Power distribution, Industry Automation and Home Electric to our long-term customers and partners in over 50 countries where we are present.

Himel. Reliable made affordable



Contents



Himel Variable Speed Drives	04
Himel Variable Speed Drives (VSD) Family	05
Your Benefits	06
Special Features and Benefits	07
Target Applications	09
Know Your Machine Better	11
Product Specification	13
Reference Selection	14
References & Mechanical Data	15
CAD Diagrams	17
Wiring Diagrams	18
Accessories	19
Accessory Selection	21
System Architecture	23
Options for System Integration	24
Circuit Breaker Selection	25
Contact Us	28



Himel Variable Speed Drives (VSD)

Himel variable speed drives offer you a wide range of fully tested and ready-to-connect motor control possibilities. From simple pump and fan applications to complex, high-performance machines, we have a reliable affordable drive for you, no matter what you need.

High Performance

Improved Energy Savings

Multitude of Function

Easy to Use

Longer Lifetime







Himel Variable Speed Drives (VSD) Family

Capacity Range (Motor Capacity in kW)																										
0.4	0.75	1.5	2.2	3.7	4	5.5	7.5	11	15	18.5	22	30	37	45	55	75	90	110	132	160	185	200	220	250	280	315
EXPERT XS																										
HAV-XS-2S																										
HAV-XS-2T																										
HAV-XS-4T																										
EXPERT XC																										
HAV-XC-2S																										
HAV-XC-4T																										
BASIC																										
HAV-XS-2S																										
HAV-XS-4T																										

* 2S = 200-240V Single Phase, 2T = 200-240V Three Phase, 4T = 380-440V Three Phase

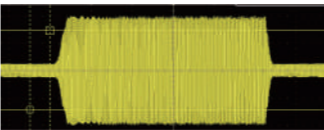

Your Benefits

	Features	Your benefits
High performance 	<ul style="list-style-type: none"> ◆ Excellent overload performance: 150% 60s, 180% 3s, 200% 1s (normal test environment) ◆ High start torque performance: 0.5Hz, 150% ◆ Excellent current control capability : The inverter provides sufficient stable output torque when the load is suddenly changed to avoid trip operation 	<ul style="list-style-type: none"> ◆ Improves productivity of machine ◆ Less interruptions of the production line
Improved energy savings 	<ul style="list-style-type: none"> ◆ Integrated Eco-mode for V/f and V²/f automatically adapts the motor magnetic flux to save energy. ◆ Improved special PID control with sleep mode helps to save more energy for pump application 	<ul style="list-style-type: none"> ◆ Energy savings during low dynamic load cycles such as pump and fan. ◆ Increases the potential savings by up to 70%. ◆ Greatly reduces the return time of investment.
Multitude of function 	<ul style="list-style-type: none"> ◆ With a new software platform, our VSDs offer more functions such as flexible V/F curve, 16 stage multi- speed control, command binding, industry specific functions, and many more. ◆ Easy to communicate with upper controller via built-in RS485 Modbus protocol . 	<ul style="list-style-type: none"> ◆ No additional upper controller is needed for stand-alone machine, hence saving the system integration cost. ◆ Easy to do the system integration for large production line and long distance communication
Easy to use 	<ul style="list-style-type: none"> ◆ Compact design and side-by-side mounting, din-rail installation. ◆ High accuracy motor parameters self-tuning function ◆ Supports pluggable keypad and extension keypad ◆ Wall-through mounting ◆ AVR (Automatic voltage regulation) technology 	<ul style="list-style-type: none"> ◆ Makes it possible to use in smaller cabinets ◆ No need to set motor parameters anymore ◆ Easy to operate and maintain
Longer lifetime 	<ul style="list-style-type: none"> ◆ Stable operation under main input voltage fluctuations. Reliable operation with net tensions between 380 V and 480 V (-15%/+10 %) ◆ Fully coated PCB ◆ Dust shield cover ◆ Better cooling and removable fan design 	<ul style="list-style-type: none"> ◆ Wider voltage range, increases robustness of the drive in difficult environment ◆ Automatic adaptation in case of unstable power supply ◆ Longer life in high humid and high dust occasions ◆ Easy to maintain



SPECIAL FEATURES & BENEFITS

PID with sleep mode

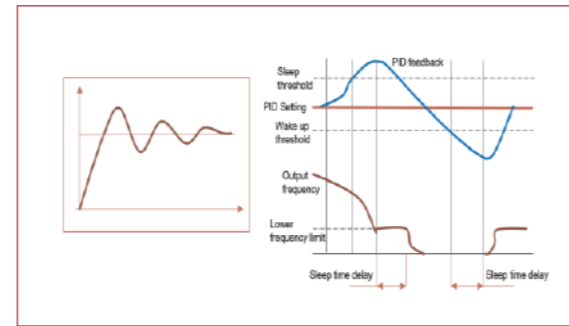

- ◆ Water supply PID adjustment: If the feedback pressure is higher than the set pressure, start the sleep detection to save more energy.
- ◆ After the sleep time delay, if the feedback pressure is still greater than the set pressure, the VSD enters into the sleep mode and slows down to the lower frequency
- ◆ When the feedback pressure reach to the wake up threshold pressure and the wake up detection time passes, it will start automatically
- ◆ Target applications: Pump for HVAC, Water /Waste water

E B

Non-stop function

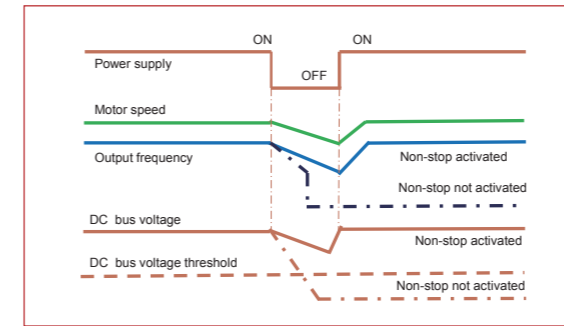

- ◆ When an instant power loss occurs, the VSD guarantees the continuous operation of the production line, which meets the continuous operation process requirement in conditions like lightning, large power grid impact and unstable power supply environments.
- ◆ Target applications: Chemical fiber, textile

E B

Easy to add customized function like fixed point stop control

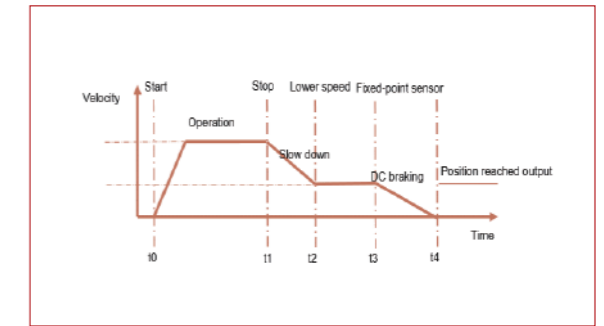

- ◆ Always stop at fixed point
- ◆ When there is a stop command, the motor slows down to the lower speed point, searches for a fixed stop point (usually connected to DI input by a sensor), stops at this point, and triggers an output position signal.
- ◆ Target applications: Needling machine, rotating table

E

Simple PLC

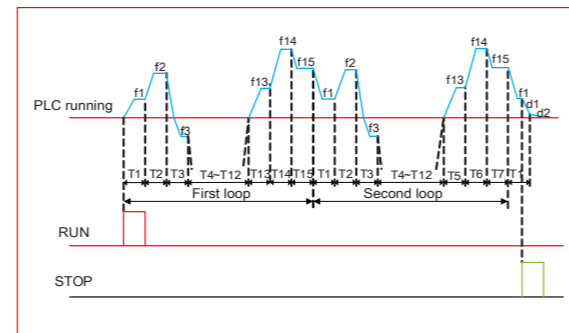

- ◆ Multistage speed control for up to 16 stages. Frequency, time, timer unit and direction for each stage can be set individually.
- ◆ PLC operation mode:
 - Single cycle (After a single cycle it keeps running at final value)
 - Continuous cycle
- ◆ No need for upper controller
- ◆ Target applications: Fan, ball mill, centrifuge

E B

Main + auxiliary frequency set

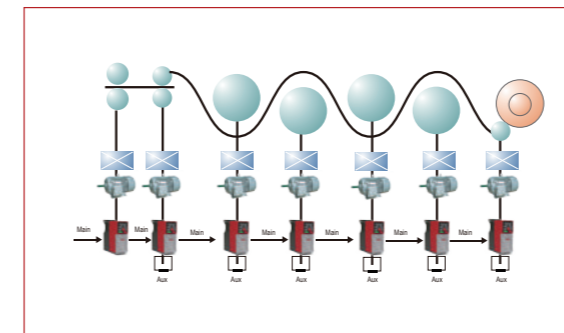

- ◆ Receives the frequency in any state, such as I/O, simple PLC, PI closed loop, multi-speed state. It uses auxiliary frequency for super precise speed.
- ◆ Target applications: Synchronization use case

E B

Rich communication protocols



- ◆ Communication expansion card supports a wide range of communication protocols, making it easy to be integrated to the system and realize long-distance transmission.
- ◆ Supports functional expansion cards like I/O, PG and other customized cards.

E

Fixed-length control

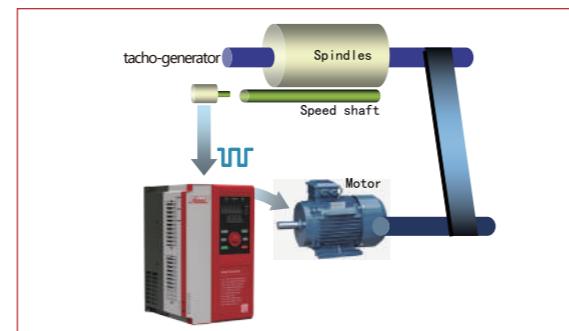

- ◆ Use DI4/DI5 (DI4/DI5 = 44) to input speed pulse for real-time length measurement. When the set length (set by FC.14) is reached, it triggers the length reached signal, and the fixed-length function is realized.
- ◆ Target applications: Textile machine, cable drawing machine

E B

Sagging function

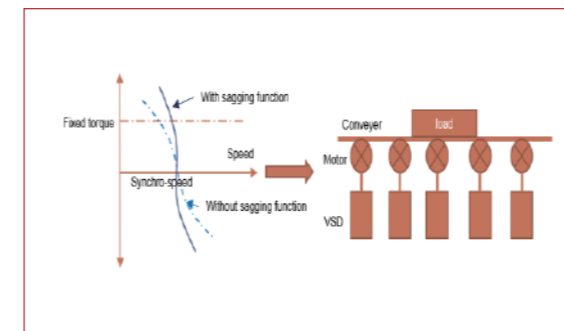

- ◆ When more than one motor drives the same load, this function can be used to adjust the speed of the motor for uniform distribution of load.
- ◆ Target applications: Tension control in chemical industry and roll control in glass and metallurgy industry

E B



E Expert
B Basic

Wherever you need an efficient motor, a variable speed drive is a must...

BASIC Series: Small & Simple General Purpose Applications

EXPERT Series: Pumps, Fans & Advanced General Purpose Applications

0.4kW ~ 315kW
220V | 380V - 440V

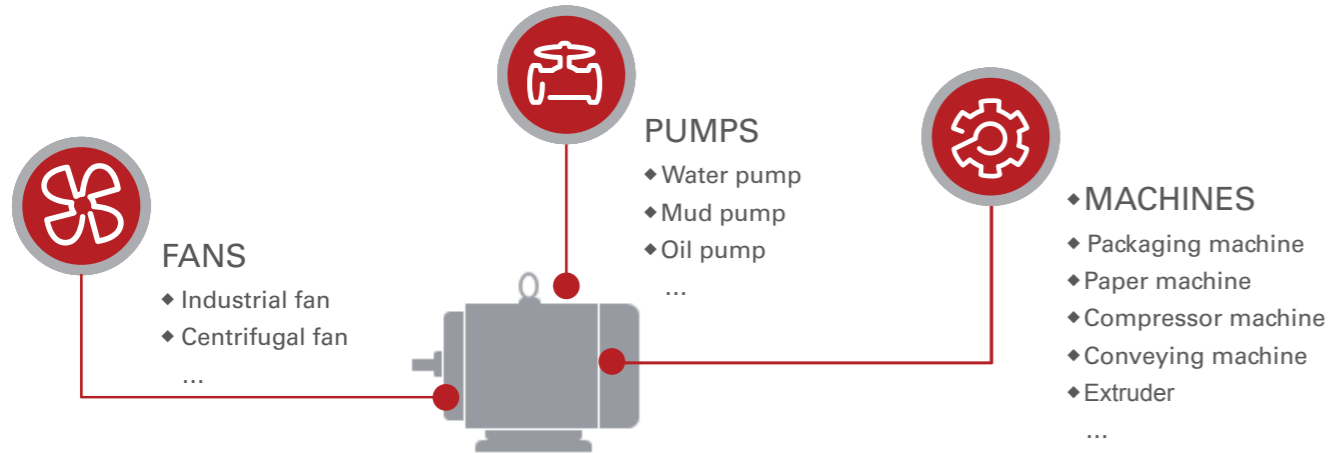

Target Applications

BASIC Series

- Small machines:
- ◆ Bread machine
 - ◆ Bag machine
 - ◆ Carving machine
- Simple applications:
- ◆ Small conveyor
 - ◆ Small fan
 - ...

EXPERT Series

- Pumps:**
- ◆ Water pump
 - ◆ Paper mill and pulp pump
 - ◆ Sewage pump
 - ◆ Fire patrol pump
 - ◆ Rod pump
- Fans:**
- ◆ Industrial fan
 - ◆ Air blower
 - ◆ Ventilation

- Heavy & complicated machines:**
- ◆ Material handling machine
 - ◆ Textile machine
 - ◆ Material working machine
 - ◆ Industrial washing machine
 - ◆ Air compressor
 - ◆ Construction elevator
- Advanced applications:**
- ◆ Metal & mining process
 - ◆ Petrochemical

Target Applications



■ Irrigation



■ Sewage



■ Fountain



■ Sand pump



■ Circulating pump



■ Photovoltaic pump



■ Rod pump

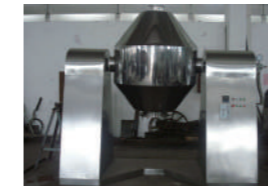

■ Drying



■ Ventilation



■ Dust removal



■ Air blowing



■ Hot surface treatment



■ Air supply fan for boiler



■ Industrial fan



■ Punching



■ Grinder



■ Textile



■ Carving



■ Sawing machine



■ Metal work



■ Plastic work



KNOW YOUR MACHINE BETTER



HVAC, Water and Waste Water



E B

Fans, Pumps, and Air Conditioning

- ◆ Integrated Eco-mode on V/f and V²/f control automatically adapts motor flux to save energy.
- ◆ Improved Special PID control with sleep mode for pump application can help to save more energy.
- ◆ Speed tracking: For smooth catching and restarting of a running fan.
- ◆ Dry pump protection, automatically detects a dry running pump to protect the equipment.

Textile and Dyeing



E

Heat setting stenter, twister, air-flow spinning, spinning machine, thin-film machine, chemical fiber industry, and needling machine

- ◆ Separate cooling channel: Detachable cooling fan design makes it easy to clean cotton.
- ◆ Wall-through mounting option(≤185kW) , dust shield cover option (≤22kW) and dust filter option
- ◆ Enhanced PCB coating
- ◆ Wide input voltage range, able to work for a long time under low voltage environments.
- ◆ Non-stop function to guarantee the continuous operation of production line.
- ◆ Fixed-length control and fixed-point stop control
- ◆ Main + auxiliary frequency set

Woodworking machinery



E B

Wood and veneer cutting machines, planers, peeling machine, carving machines

- ◆ Integrated brake choppers: No need to purchase an external brake chopper.
- ◆ DIN rail mounting and quick I/O connection, quick and easy installation and maintenance.
- ◆ Multiple display options: Extendable LED/LCD display keypad. Integrated multi-stage speed control (16 steps) and simple PLC function without any additional PLC.
- ◆ High start torque, high frequency output (650Hz), accurate speed control for highly dynamic applications to improve the productivity .

Metal processing machinery



E B

Lathe, grinder, drill, planer, boring, cold forging, and engraving machine

- ◆ Compact design
- ◆ DIN rail mounting (up to 5.5 kW) and side by side mounting (up to 22 kW).
- ◆ High start torque, high frequency output (650Hz), and accurate speed control for highly dynamic applications to improve the productivity.
- ◆ Integrated brake chopper.
- ◆ Over excitation braking can help to reduce braking times by up to 50% without any external braking resistor.
- ◆ Sagging function
- ◆ Main + auxiliary frequency set

Food and packaging



E B

Conveyor, blow molding, blender, cutter, and labeling machines

- ◆ Compact design
- ◆ DIN rail mounting (up to 5.5 kW) and side by side mounting (up to 22 kW).
- ◆ Counter function using DI4/DI5
- ◆ Extendable LED/LCD display keypad support for convenient and safe monitoring and operation.
- ◆ Integrated multi-stage speed control (16 steps) and simple PLC function without any additional PLC.
- ◆ Fixed-length control for cutting process.
- ◆ Fixed-point stop control

Rubber and plastic machinery





E B

Scroll extruder, pelletizer, and bagging machine



- ◆ Compact design
- ◆ DIN rail mounting (up to 5.5 kW) and side by side mounting (up to 22 kW), to save cabinet space.
- ◆ High start torque, high frequency output (650Hz), accurate speed control for highly dynamic applications to improve the productivity .
- ◆ Precise control to ensure the material thickness evenly, in order to save cost and ensure the quality of products.
- ◆ Torque limit and slip compensation, especially used for constant output torque. Minimize the torque fluctuations and improve the extrusion process quality.

Basic
Expert
E

Product Specifications

Target Application		Small & Simple General Purpose Applications	P&F & Advanced General Purpose Applications		
Range Name		BASIC	EXPERT XC	EXPERT XS	
Design					
Capacity range	Single phase 200V Class	200V(-10%)-220V(+10%) 0.75~2.2kW	200V(-15%)-240V(+10%) 0.4~2.2kW	200V(-15%)-220V(+10%) 0.75~2.2kW	
	Three phase 200V Class	—	—	200V(-15%)-240V(+10%) 4~45kW	
	Three phase 400V Class	380V(-15%)-440V(+10%) 0.75~5.5kW	380V(-15%)-440V(+10%) 0.75~4kW	380V(-15%)-440V(+10%) 0.75~280kW	
Frequency	Input frequency	50/60Hz			
	Output frequency	0-650Hz	0-550Hz		
Overload capacity	Normal Duty	—	—	120% for 1min, 150% for 1s, 180% instant protection	
	Heavy Duty	150% for 1min, 180% for 1s, 200% instant protection	150% for 1min, 180% for 3s, 200% instant protection	150% for 1min, 180% for 3s, 200% instant protection	
Control method	V/f	√	√	√	
	Sensor less vector control	√	√	√	
	Eco-mode control	√	√	√	
Start torque		0.5Hz, 150%			
Inbuilt PID		√	√	√	
Keypad		Fixed	Fixed	Pluggable	
Display		LED	LED	Double row LED	
Multispeed control		Up to 16 stages in one cycle			
I/O	DI1-DI4	NPN/PNP, Input: 9-30VDC	NPN/PNP, Input: 9-30VDC	NPN/PNP, Input: 9-30VDC	
	DI5	NPN/PNP, Input: 9-30VDC, Pulse input: max. 50kHz	NPN/PNP, Input: 0-24VDC, Pulse input: max. 100kHz	NPN/PNP, Input: 9-30VDC, Pulse input: max. 200kHz	
	DO1	9-30VDC, max. 50mA			
	DO2	9-30VDC, max. 50mA Pulse output max. 50kHz			
	AI1	V: 0-10V I: 0-20mA Resolution: 1/1000	V: 0-10V I: 0-20mA Resolution: 1/1000	V: 0-10V I: 0-20mA Resolution: 1/1000	
	AI2	V: 0-10V Resolution: 1/1000			
	AO1	V: 0-10V Resolution: 1/1000	V: 0-10V I: 0-20mA Resolution: 1/1000	V: 0-10V I: 0-20mA Resolution: 1/1000	
	AO2	V: 0-10V I: 0-20mA Resolution: 1/1000	—		
	RO(Ta, Tb, Tc)		NO: 24VDC 3A / 250VAC 5A NC: 24VDC 3A / 250VAC 3A		
	Inbuilt communication (Max. speed)		RS485, Modbus RTU (38.4kbps)		
Options	Communication	—	—	CANopen, Profibus, DeviceNet, Ethernet/IP, EtherCAT, Profinet	
	Extension I/O	—	—	DI/DO/AI/AO/RO/PT100/PT1000	
	Extension keypad	Support, cable length: 2m, 5m			
Installation Way		Wall mounted, cabinet, Din-rail	Wall mounted, cabinet, Din-rail	Wall mounted, cabinet, flange installation	
Dust Shields		—	Optional	Optional	
Simple EMC Filter		—	—	Built-in (0.7kW-22kW, 200kW-280kW) Optional (30kW-185kW)	
Braking unit		Built-in	Built-in	Built-in (<= 18.5kW)	
Environment and certificate	Operation temperature	-10-40 °C no capacity reduction, 40 °C -50°C capacity reduction			
	Humidity	≤90%RH			
	Altitude	≤1000m, no capacity reduction			
	IP level	IP20			
	Global certificates	CE	CE	CE	

Product Specifications

Target Application		Small & Simple General Purpose Applications	P&F & Advanced General Purpose Applications	
Range Name		BASIC	EXPERT XC	EXPERT XS
Design				
Features	Velocity ratio	1:100		
	Frequency precision	Digital setting: Max frequency X ±0.01% Analog setting: Max frequency X ±0.2%		
	Frequency resolution	Digital setting :Max frequency X ±0.01% Analog setting: Max frequency X ±0.1%		
	Torque rise	Integrated auto-torque rising function Manual- setting: 0.1%~30.0%		
	V/F control curve definition	4 solution: Linear V/F, Square V/F, V ^{1.7} /F, V ^{1.2} /F		
	Acceleration/Deceleration Time	4 types of ACC/DEC time selection; optional time unit selection (Min/s); setting range: 0~60hours;		
	DC braking	Start frequency: 0.00~60.00Hz; braking time: 0.0~30.0s; braking current: 0.0~100%		
	Automatic voltage regulation(AVR)	Can keep the output voltage stable by adjusting PWM output automatically when the input voltage is not stable.		
	Auto current limitation	Limits current automatically to avoid tripping from frequent over current.		
	Auto PWM adjustment	Can adjust the PWM frequency automatically according to the load characteristic		
Protection	Prevent mis operation	—	Protect the VSD parameters from change to avoid drives mis operation	
	Protection function	Over-current, over-voltage, under-voltage, over-heat, over-load, short circuit.		
	Cooling	Air-cooling		

Reference Selection

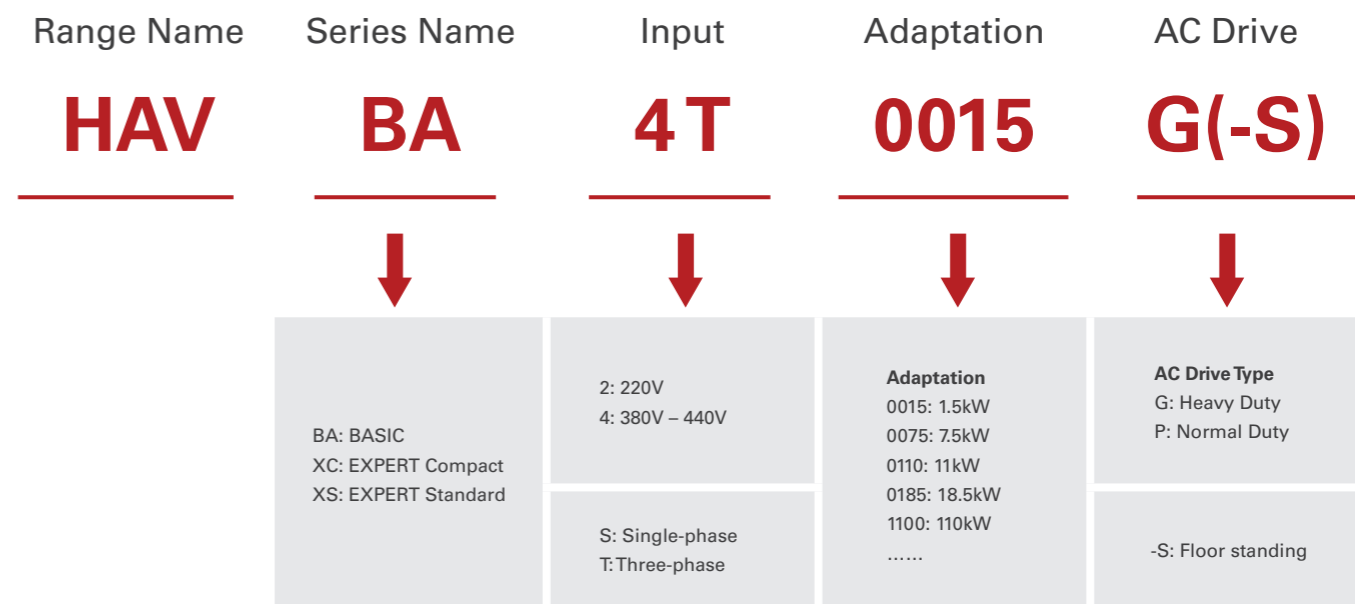

CAD Diagrams

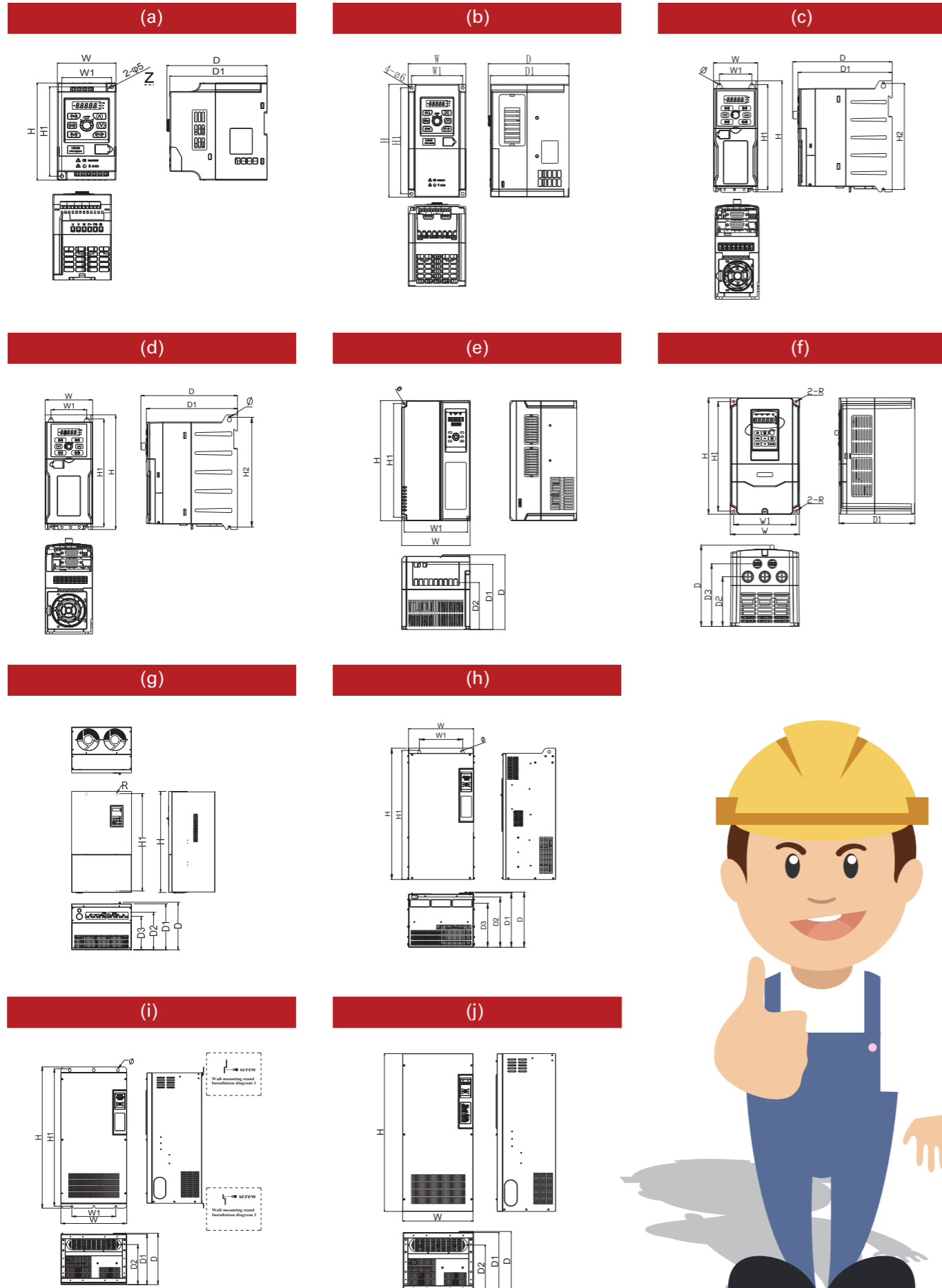

Wiring Diagrams

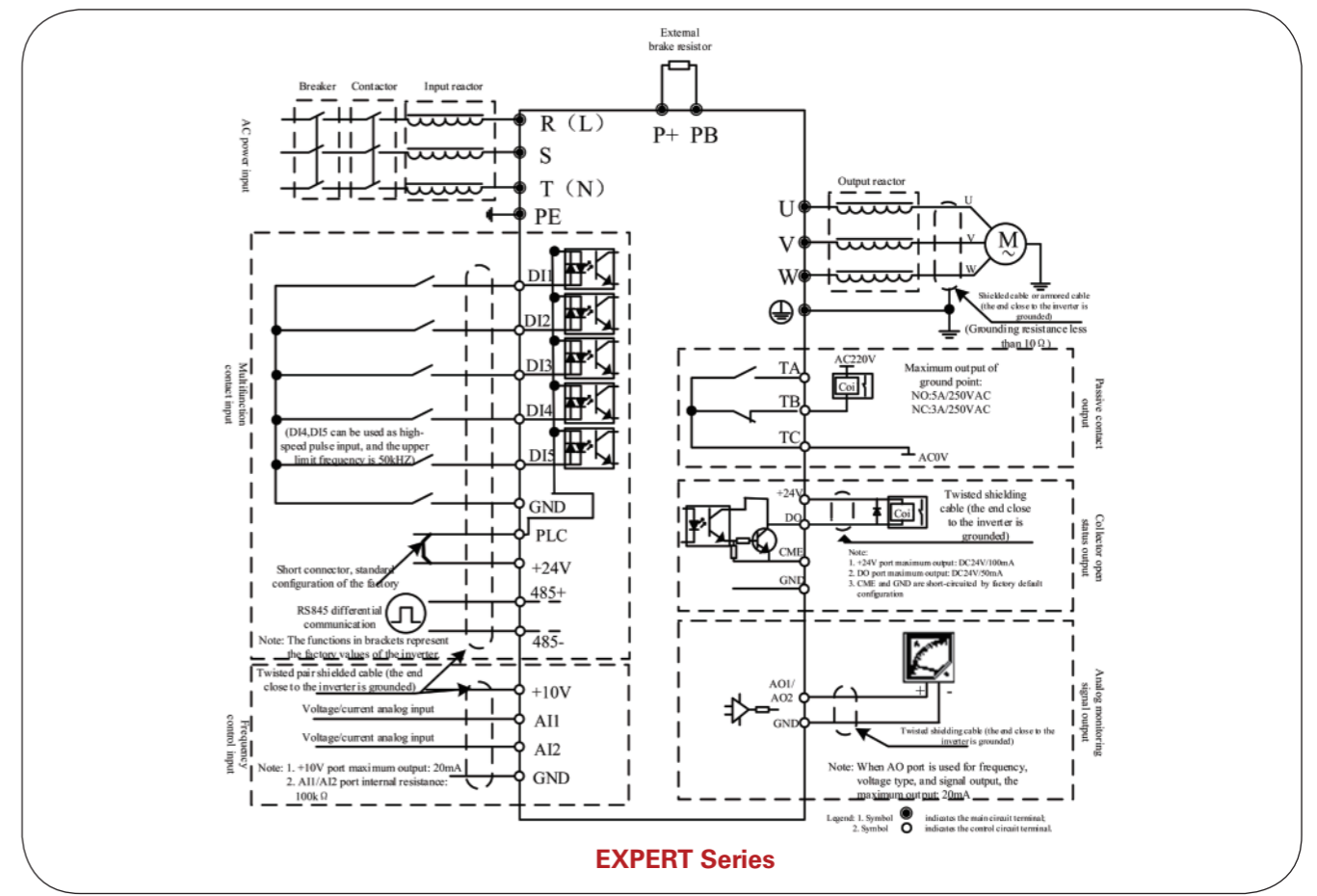
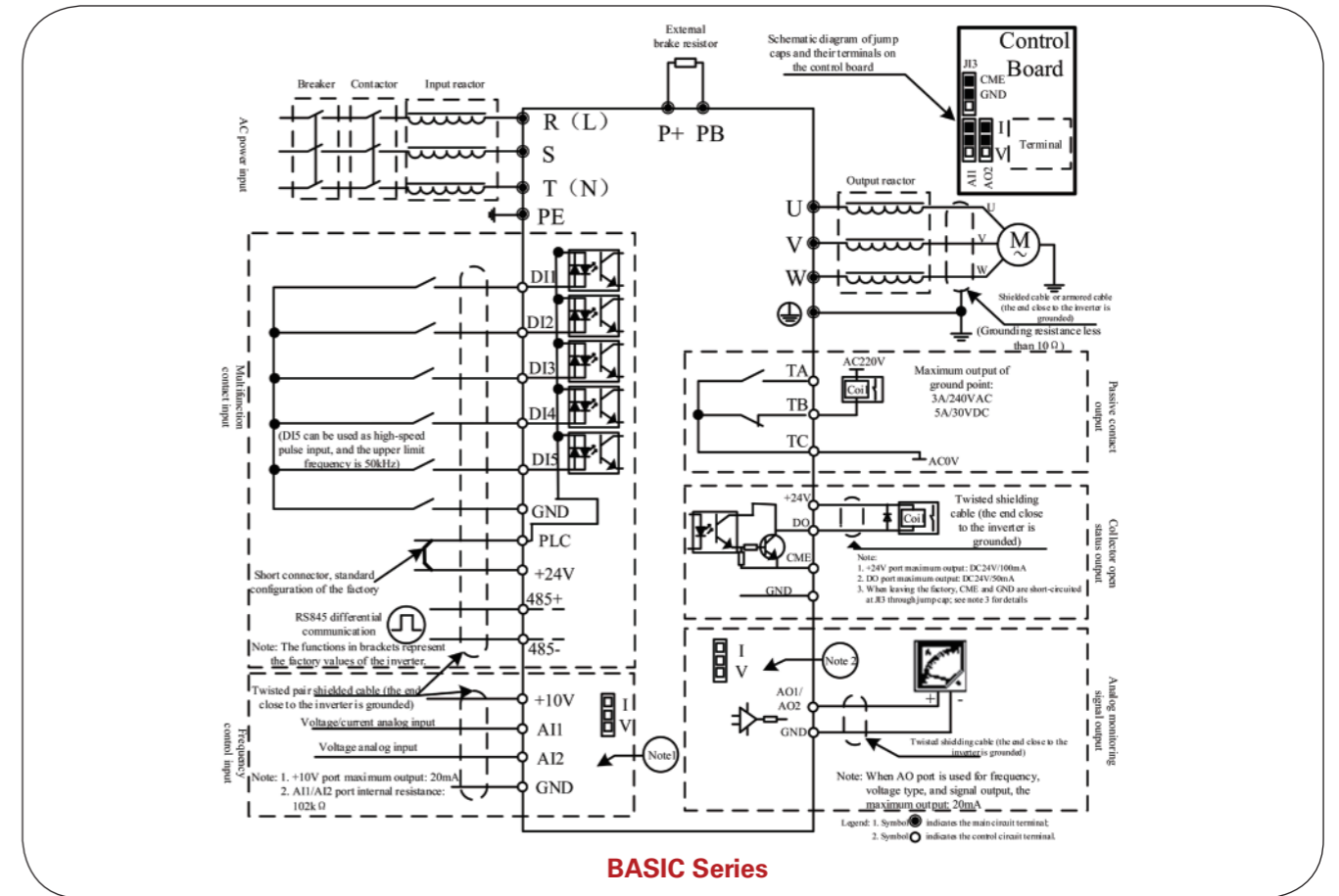

Accessories

Adapted for harsh environment

Dust-proof design: Comprehensive anti-corrosion coating and independent air duct design. Optional dust preventing accessories can also be installed to increase overall protection capabilities against high humid or excessively dusty environments.

Target Applications: Textile machines



Modular Design

Easy fan replacement : No need to disassemble the entire VSD for a quick fan replacement. This ease of fan change makes the VSD ideal for applications like wind machine that need regular cleaning of air ducts.

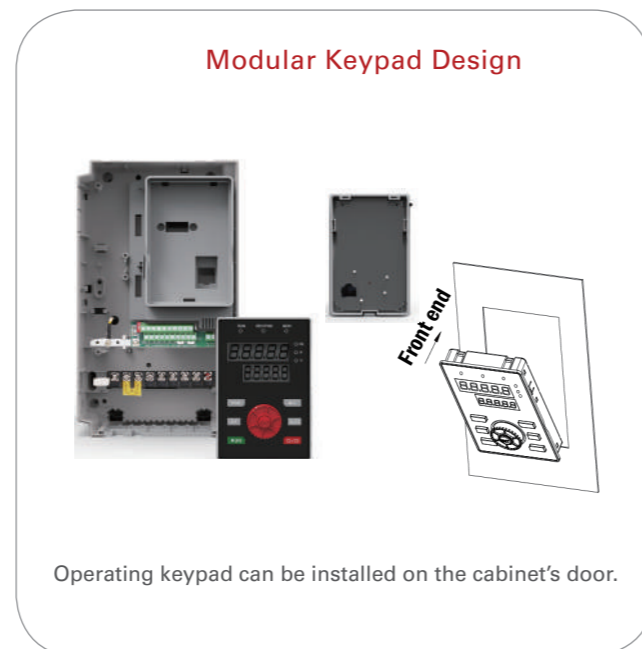

Accessories

Great adaptability to environment

Power grid: Suitable for neutral grounded power grids.

EMC: Enhanced electromagnetic interference immunity against disturbances like surge, electric noise, high frequency noise and static electricity etc.

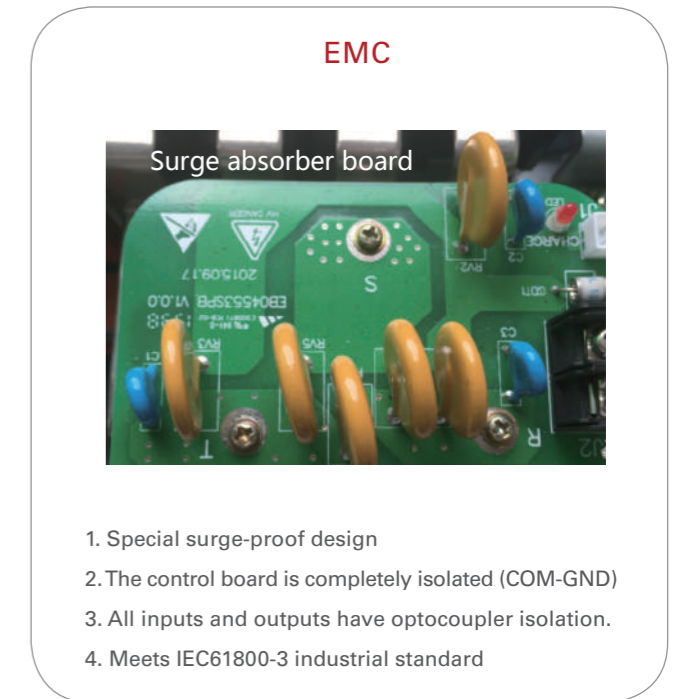



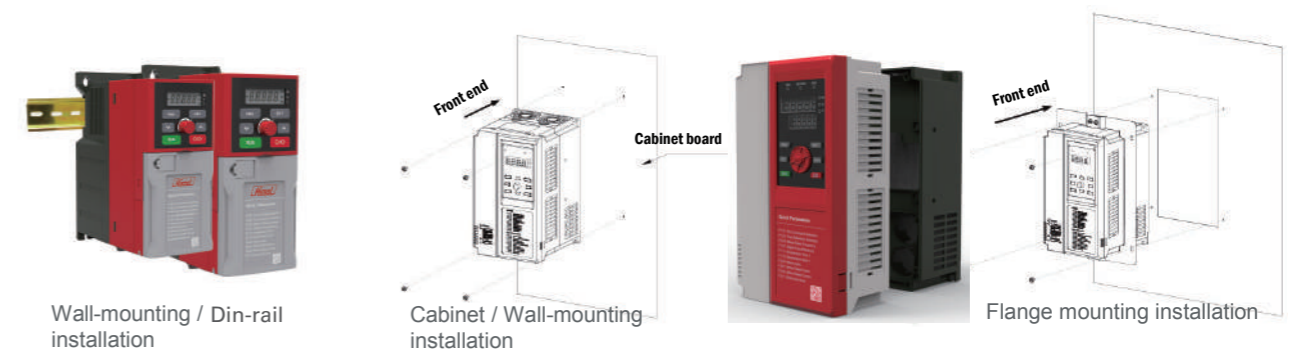

Easy and comprehensive installation

Comprehensive installation ways to fulfill all kinds of applications:





- ◆ Cabinet
- ◆ Wall-mounting
- ◆ Din rail
- ◆ Flange mounting



Accessories Selection

Category	Type	Range	Commercial Reference	Short Description	Applicable Product		Pictures
					Applicable Commercial Reference	Specifications	
ADD-ON	EMC filter card	Expert XS	HAV-XS-4T0370G-FL	Simple EMC filter	HAV-XS-4T0300G-0370P ~ HAV-XS-4T0370G-0450P	4T*: 30 - 37kW	
			HAV-XS-4T0550G-FL		HAV-XS-4T0450G-0550P ~ HAV-XS-4T0550G-0750P	4T*: 45 - 55kW	
			HAV-XS-4T1850G-FL		HAV-XS-4T0750G-0900P ~ HAV-XS-4T1850G-2000P	4T*: 75 - 185kW	
	EtherCAT Card	Expert XS	HAV-XS-EtherCAT	Extension card for EtherCAT communication	HAV-XS-4T0007G ~ HAV-XS-4T2800G-3150P	4T*: 0.75kW - 280kW	
IO extension card	Expert XS	HAV-XS-IO-3DI-R	IO extension card with 3 Di and 1 relay	HAV-XS-4T0007G ~ HAV-XS-4T2800G-3150P	4T*: 0.75kW - 280kW		
		HAV-XS-IO-5DI-AI-R	Standard IO Extension 5 DI, 1 DO, 1 AI, 1 Relay	HAV-XS-4T0007G ~ HAV-XS-4T2800G-3150P	4T*: 0.75kW - 280kW		
Profinet Card	Expert XS	HAV-XS-Profinet-1	Extension card for Profinet communication	HAV-XS-4T0007G ~ HAV-XS-4T2800G-3150P	4T*: 0.75kW - 280kW		
Dust Preventive Accessories	Dust cover	EXPERT XS	HAV-XS-FCB	Dust prevention cover	HAV-XS-2S0007 ~ HAV-XS-2S0022G HAV-XS-2T0007G ~ HAV-XS-2T0220G-0300P HAV-XS-4T0007G ~ HAV-XS-4T0220G-0300P	2S*: 0.75 - 2.2kW 2T*: 0.75 - 2.2kW 4T*: 0.75 - 2.2kW	
		BASIC BA	HAV-BA-4T0040		HAV-BA-2S0022G HAV-BA-4T0040G HAV-BA-4T0055G	2S*: 2.2kW 4S*: 4kW, 5.5kW	
	Dust Guaze	Expert XC	HAV-XC-4T0015-JFZ	Dust sticker for EXPERT Series	HAV-XC-4T0007G~HAV-XC-4T0022G HAV-XC-2S0007G~HAV-XC-2S0015G	2S*: 0.75 - 1.5kW 2T*: 0.75 - 1.5kW	
			HAV-XC-4T0040-JFZ		HAV-XC-4T0040G HAV-XC-2S0022G	2S*: 2.2kW 4T*: 4.0kW	
		Expert XS	HAV-XS-4T0075-FSB		HAV-XS-4T0055G-0075P HAV-XS-4T0075G-0110P	4T*: 5.5kW , 7.5kW	
			HAV-XS-4T0150-FSB		HAV-XS-4T0110G-0150P HAV-XS-4T0150G-0180P	4T*: 11kW, 15kW	
	Dust Sticker	BASIC BA	HAV-BA-4T0022	Dust sticker for BASIC Series	HAV-BA-2S0007G ~ HAV-BA-2S0022G HAV-BA-4T0007G ~ HAV-BA-4T0055G	2S*: 0.75 - 2.2kW 4T*: 0.75 - 5.5kW	
		Expert XS	HAV-XS-FCT	Dust sticker for EXPERT Series	HAV-XS-2S0007G ~ HAV-XS-2S0022G HAV-XS-2T0007G ~ HAV-XS-2T1600G	2S*: 0.75 - 2.2kW 4T*: 4 - 7.5kW	

Accessories Selection

Category	Type	Range	Commercial Reference	Short Description	Applicable Product		Pictures	
					Applicable Commercial Reference	Specifications		
Installation Accessories	Flange-mounting	Expert XS	HAV-XS-4T0040-QRZJ	Embedded installation accessories	HAV-XS-4T0007G ~ HAV-XS-4T0040G-0055P HAV-XS-2T0007G ~ HAV-XS-2T1600G	4T*: 0.75 - 4kW 2S*: 0.75 - 2.2kW		
			HAV-XS-4T0075-QRZJ		HAV-XS-4T0055G-0075P ~ HAV-XS-4T0075G-0110P	4T*: 5.5 - 7.5kW		
			HAV-XS-4T0150-QRZJ		HAV-XS-4T0110G-0150P ~ HAV-XS-4T0150G-0185P	4T*: 11 - 15kW		
			HAV-XS-4T0220-QRZJ		HAV-XS-4T0185G-0220P ~ HAV-XS-4T0220G-0300P	4T*: 18.5 - 22kW		
			HAV-XS-4T0370-QRZJ		HAV-XS-4T0300G-0370P ~ HAV-XS-4T0370G-0450P	4T*: 30 - 37kW		
			HAV-XS-4T0750-QRZJ		HAV-XS-4T0450G-0550P ~ HAV-XS-4T0750G-0900P	4T*: 45 - 75kW		
			HAV-XS-4T1320-QRZJ		HAV-XS-4T0900G-1100P ~ HAV-XS-4T1320G-1600P	4T*: 90 - 132kW		
			HAV-XS-4T1600-QRZJ		HAV-XS-4T1600G-1850P ~ HAV-XS-4T1850G-2000P	4T*: 160 - 185kW		
	Wall-mounting	Expert XS	HAV-XS-4T2200-BGZJ	Accessory for wall mounting installation	HAV-XS-4T2000G-2200P ~ HAV-XS-4T2200G-2500P	4T*: 200 - 220kW		
			HAV-XS-4T2800-BGZJ		HAV-XS-4T2500G-2800P ~ HAV-XS-4T2800G-3150P	4T*: 250 - 280kW		
	Floor-standing	Expert XS	HAV-XS-4T0370-DZ	Accessory for floor-standing installation	HAV-XS-4T0300G-0370P ~ HAV-XS-4T0370G-0450P	4T*: 30 - 37kW		
			HAV-XS-4T0750-DZ		HAV-XS-4T0450G-0550P ~ HAV-XS-4T0750G-0900P	4T*: 45 - 75kW		
HAV-XS-4T1100-DZ			HAV-XS-4T0900G-1100P ~ HAV-XS-4T1320G-1600P		4T*: 90 - 132kW			
HAV-XS-4T1600-DZ			HAV-XS-4T1600G-1850P ~ HAV-XS-4T1850G-2000P		4T*: 160 - 185kW			
Keyboard & Accessories	Keyboard bracket	Expert XS	HAV-XS-JPT	Keypad holder for external keypad	HAV-XS-2S0007G ~ HAV-XS-2S0022G HAV-XS-2T0007G ~ HAV-XS-2T1600G HAV-XS-4T0007G ~ HAV-XS-4T2800G-3150P	2S*: 0.75 - 2.2kW 2T*: 4 - 7.5kW 4T*: 0.75kW ~ 280kW		
					External Keyboard	BASIC BA		HAV-BA-LKD
	EXPERT XC	HAV-XC-LKD	HAV-XC-2S0004G~HAV-XC-2S0022G HAV-XC-4T0007G~HAV-XC-4T0040G	2S*: 0.40 - 2.2kW 4T*: 0.75 - 4.0kW				
	EXPERT XS	HAV-XS-LKD	External keyboard for EXPERT XS	HAV-XS-2S0007G ~ HAV-XS-2S0022G HAV-XS-2T0007G ~ HAV-XS-2T1600G HAV-XS-4T0007G ~ HAV-XS-4T2800G-3150P		2S*: 0.75 - 2.2 kW 2T*: 4 - 7.5kW 4T*: 0.75 - 280kW		
	Keyboard cable	BASIC	HAV-XS-CAB	Keyboard extension wire Length: 2m, 5m		HAV-BA-2S0007G ~ HAV-BA-2S0022G HAV-BA-4T0007G ~ HAV-BA-4T0055G	2S*: 0.4 - 2.2 kW 2T*: 0.75 - 160kW 4T*: 0.75 - 280kW	
		EXPERT XC			HAV-XC-2S0004G ~ HAV-XC-2S0022G HAV-XC-4T0007G ~ HAV-XC-4T0040G			

* 2S = 200-240V Single Phase, 2T = 200-240V Three Phase, 4T = 380-440V Three Phase

System Architecture

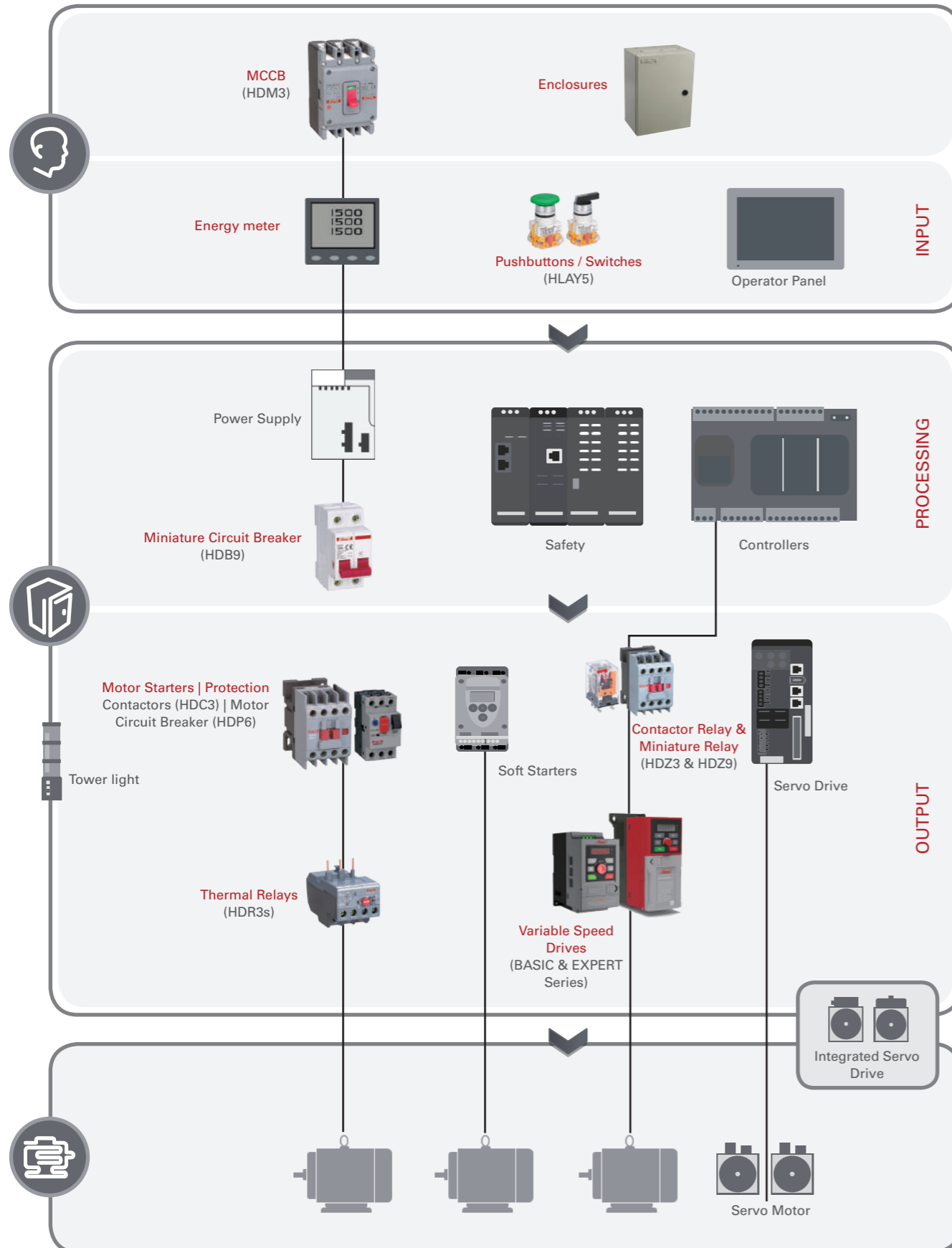

Options for System Integration

Push Buttons (HLAY5)

- ◆ Degree of protection: IP44 (IP65 with protection cover)
- ◆ Type: Flush button / Mushroom / Selector switches / Key switches / Emergency stop / Illuminated / Double / Pilot light
- ◆ Drilling / Cut-out for mounting: $\varnothing 22\text{mm}$
- ◆ Standard: IEC 60947-5-1



Push Button



Selector Switches



Push Button Switches



Indicator Light

Indication Light (HLD11)

- ◆ Degree of protection: IP65
- ◆ Type: Full cover head/ Half cover head/ Long terminal/ Short terminal
- ◆ Color: White/ Green/ Red/Yellow/ Blue
- ◆ Drilling or cut-out for mounting: $\varnothing 22\text{mm}$
- ◆ Standard: IEC 60947-5-1

Relay (HDZ9)

Rated Current: 3A, 5A, 10A

- ◆ Poles: 2-pole, 3-pole, 4-pole
- ◆ Maximum Rated Operating Voltage: 690V
- ◆ Rated Operating Frequency: 50/60Hz
- ◆ Coil Specification: DC: 6V~220V; AC: 6V~380V
- ◆ Additional Feature: Rotary push button
- ◆ Certificate: CB, CE

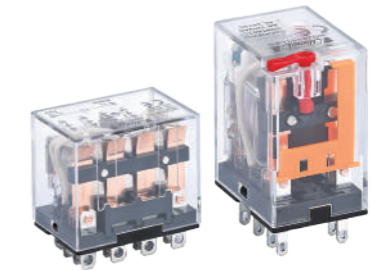

Contactor Relay (HDZ3)

- ◆ Pole: 3-pole
- ◆ Coil Voltage: 24-440V
- ◆ Coil Frequency: 50Hz, 50/60Hz
- ◆ Certificate: CE



Miniature Circuit Breaker (HDB9)

- ◆ Elegant and clear indication window
- ◆ New clip design makes it easy to install
- ◆ Square terminal and connection holes makes it more secure to connect wiring
- ◆ Specifications
 - Rated Current: 1 – 63A
 - Breaking Capacity: 6kA, 10kA
 - Frame: 63A
 - Poles: 1P, 2P, 3P, 4P



Molded Case Circuit Breaker (HDM3)

- ◆ Easy Installation
The double-deck cover design of the HDM3 series assures easy installation and removal of accessories.
- ◆ High Performance
The patent design in HDM3 ensures quick extinguishing of arc.
- ◆ Secured Operation
HDM3 is trustworthy and safe for use due to the double-deck cover design.
- ◆ Specifications
 - Frame: 63,100, 160, 250,400,630,800,1250A
 - Rated Voltage: 400/415V, 50/60 Hz
 - Breaking Capacity: 18kA - 85kA
 - Rated Current: 10A -1250A
 - Poles: 3P, 4P
 - Tripping type: Thermal Magnetic, Magnetic

Protection type: Power distribution, Motor protection
 Connection: fixed-front connection, fixed-rear connection, plug-in connection, draw-out rear connection
 Standard: IEC 60947-2
 Certificates: CE, KEMA (TUV), CB
 Operating Temp: 40°C & 50°C



Circuit Breaker Selection

Range	Input Voltage	Commercial Reference	Motor Power (kW)	Continuous Output Current (A)	Motor Power (kW)	Continuous Output Current (A)	Circuit Breaker Reference
BASIC	200-240V Single Phase	HAV-BA-2S0007G	0.75	4.5	-	-	HDB3wN2C10*
		HAV-BA-2S0015G	1.5	7.1	-	-	HDB3wN2C20*
		HAV-BA-2S0022G	2.2	9.8	-	-	HDB3wN2C20*
	380-440V Three Phase	HAV-BA-4T0007G	0.75	2.3	-	-	HDM363S1032XX2
		HAV-BA-4T0015G	1.5	3.7	-	-	HDM363S1032XX2
		HAV-BA-4T0022G	2.2	5	-	-	HDM363S1632XX2
		HAV-BA-4T0040G	4	8.8	-	-	HDM363S2032XX2
		HAV-BA-4T0055G	5.5	13	-	-	HDM363S2532XX2
EXPERT XC	200-240V Single Phase	HAV-XC-2S0004G	0.4	3	-	-	HDB3wN2C10*
		HAV-XC-2S0007G	0.75	4.5	-	-	HDB3wN2C10*
		HAV-XC-2S0015G	1.5	7.1	-	-	HDB3wN2C20*
		HAV-XC-2S0022G	2.2	9.8	-	-	HDB3wN2C20*
	380-440V Three Phase	HAV-XC-4T0007G	0.75	2.3	-	-	HDM363S1032XX2
		HAV-XC-4T0015G	1.5	3.7	-	-	HDM363S1032XX2
		HAV-XC-4T0022G	2.2	5	-	-	HDM363S1032XX2
		HAV-XC-4T0040G	4	8.8	-	-	HDM363S1032XX2
EXPERT XS	200-240V Single Phase	HAV-XS-2S0007G	0.75	5	-	-	HDB3wN2C10*
		HAV-XS-2S0015G	1.5	7.8	-	-	HDB3wN2C20*
		HAV-XS-2S0022G	2.2	10.8	-	-	HDB3wN2C20*
	200-240V Three Phase	HAV-XS-2T0007G	0.75	5	-	-	HDM363S1632XX2
		HAV-XS-2T0015G	1.5	7.8	-	-	HDM363S2032XX2
		HAV-XS-2T0022G	2.2	10.8	-	-	HDM363S2532XX2
		HAV-XS-2T0040G	3.7	16.2	-	-	HDM363S2032XX2
		HAV-XS-2T0055G	5.5	20.3	-	-	HDM363S3232XX2
		HAV-XS-2T0075G	7.5	26.7	-	-	HDM363S5032XX2
		HAV-XS-2T0110G	11	39	-	-	HDM363S6332XX2
		HAV-XS-2T0150G	15	52.5	-	-	HDM363S6332XX2
		HAV-XS-2T0185G	18.5	62.4	-	-	HDM3100S8032XX2
		HAV-XS-2T0220G	22	73.6	-	-	HDM3100S10032XX2
		HAV-XS-2T0300G	30	98.7	-	-	HDM3160S14032XX2
		HAV-XS-2T0370G	37	121	-	-	HDM3160S16032XX2
		HAV-XS-2T0450G	45	147	-	-	HDM3250S20032XX2
		HAV-XS-2T0550G	55	188	-	-	HDM3400S31532XX2

* Add 50D at the end of the reference for requirement between 40°C and 50°C

Circuit Breaker Selection

Range	Input Voltage	Commercial Reference	Motor Power (kW)	Continuous Output Current (A)	Motor Power (kW)	Continuous Output Current (A)	Circuit Breaker Reference
EXPERT XS	200-240V Three Phase	HAV-XS-2T0750G	75	256	-	-	HDM3400S31532XX2
		HAV-XS-2T0900G	90	308	-	-	HDM3400S35032XX2
		HAV-XS-2T1100G	110	376	-	-	HDM3630S50032XX2
		HAV-XS-2T1320G	132	451	-	-	HDM3630S63032XX2
		HAV-XS-2T1600G	160	547	-	-	HDM3630S63032XX2
		HAV-XS-4T0007G	0.75	2.5	-	-	HDM363S1032XX2
	380-440V Three Phase	HAV-XS-4T0015G	1.5	4.1	-	-	HDM363S1032XX2
		HAV-XS-4T0022G	2.2	5.5	-	-	HDM363S1032XX2
		HAV-XS-4T0040G-0055P	3.7	9.6	5.5	13	HDM363S1632XX2
		HAV-XS-4T0055G-0075P	5.5	13	7.5	17	HDM363S2032XX2
		HAV-XS-4T0075G-0110P	7.5	17	11	25	HDM363S3232XX2
		HAV-XS-4T0110G-0150P	11	25	15	32	HDM363S4032XX2
		HAV-XS-4T0150G-0185P	15	32	18.5	37	HDM363S4032XX2
		HAV-XS-4T0185G-0220P	18.5	37	22	45	HDM363S5032XX2
		HAV-XS-4T0220G-0300P	22	45	30	60	HDM363S6332XX2
		HAV-XS-4T0300G-0370P	30	60	37	75	HDM3100S8032XX2
		HAV-XS-4T0370G-0450P	37	75	45	90	HDM3100S10032XX2
		HAV-XS-4T0450G-0550P	45	90	55	110	HDM3160S14032XX2
		HAV-XS-4T0550G-0750P	55	110	75	157	HDM3160S16032XX2
		HAV-XS-4T0750G-0900P	75	157	90	180	HDM3250S20032XX2
		HAV-XS-4T0900G-1100P	90	180	110	214	HDM3250S25032XX2
		HAV-XS-4T1100G-1320P	110	214	132	256	HDM3400S31532XX2
		HAV-XS-4T1320G-1600P	132	256	160	307	HDM3400S31532XX2
		HAV-XS-4T1600G-1850P	160	307	185	340	HDM3400S35032XX2
HAV-XS-4T1850G-2000P	185	340	200	385	HDM3400S40032XX2		
HAV-XS-4T2000G-2200P (Wall Mounting)	200	385	220	430	HDM3630S50032XX2		
HAV-XS-4T2200G-2500P (Wall Mounting)	220	430	250	465	HDM3630S50032XX2		
HAV-XS-4T2500G-2800P (Wall Mounting)	250	465	280	525	HDM3630S63032XX2		
HAV-XS-4T2800G-3150P (Wall Mounting)	280	525	315	590	HDM3630S63032XX2		
HAV-XS-4T2000G-2200P	200	385	220	430	HDM3630S50032XX2		
HAV-XS-4T2200G-2500P	220	430	250	465	HDM3630S50032XX2		
HAV-XS-4T2500G-2800P	250	465	280	525	HDM3630S63032XX2		
HAV-XS-4T2800G-3150P	280	525	315	590	HDM3630S63032XX2		

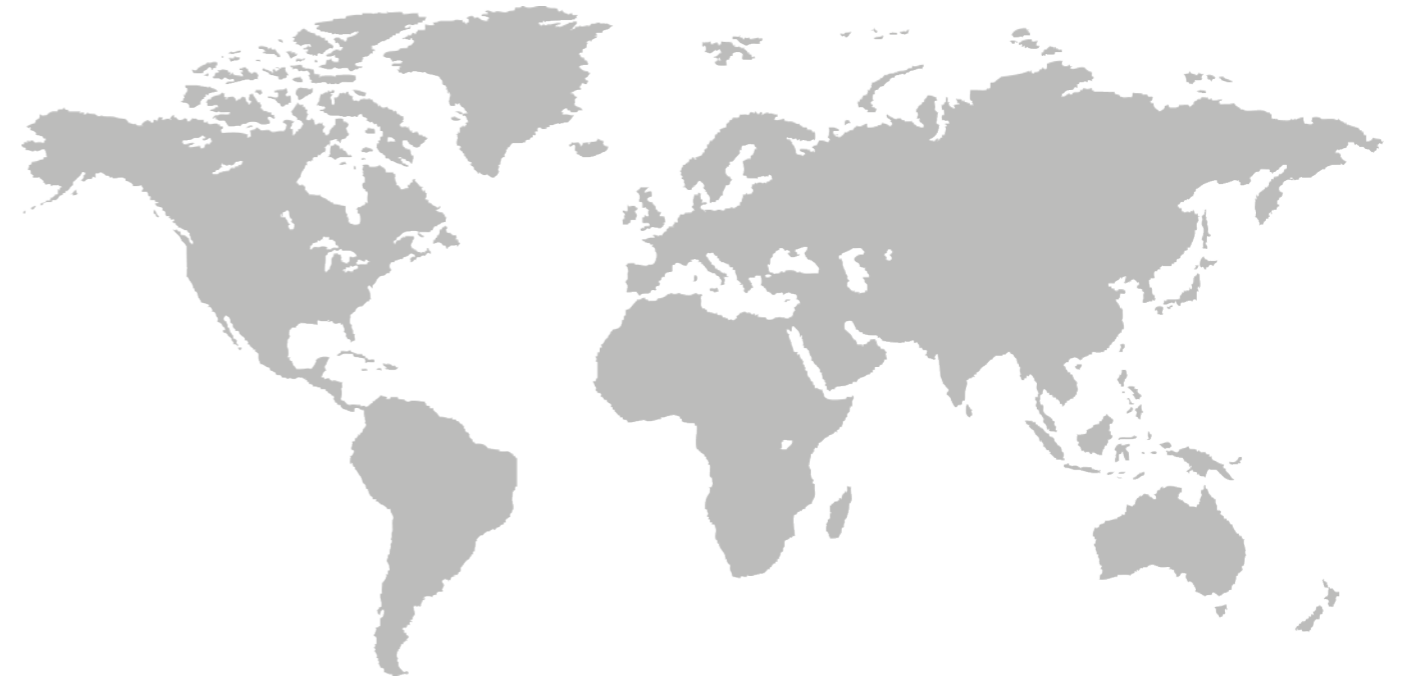

Contact Himel team
support@himel.com



Contact local distributor

Company name:

Contact:

Tel:

Email:

Address:

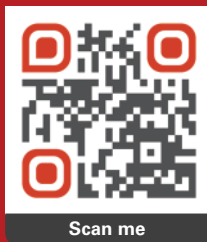

Himel
www.himel.com

June 2020



©2020 HIMEL