

ø16 H6 series Miniature Switches & Pilot Lights

Designed to ensure ease of operation and safety
Ideal for heavy duty applications such as machine tools

- Removable contact block makes installation and removal easy.
- Large operators; bezel size (ø24 mm, 24x24 mm)
- High operating force and long stroke prevent inadvertent operation.
- Contact blocks can be removed when units are mounted collectively.
- Shock- and vibration-resistant rugged design
- UL recognized, CSA certified
- EN compliant (EN 60947-1, EN 60947-5-1, TÜV approved)



- See website for details on approvals and standards.



Contact Ratings

Gold Contact

| | | |
|--|--------------------|--------|
| Rated Insulation Voltage | 250V | |
| Rated Thermal Current | 3A | |
| Rated Operating Voltage | 125V AC | 30V DC |
| Rated Operating Current (resistive load) | 0.1A | 0.1A |
| Contact Material | Gold plated silver | |

Minimum applicable load (reference value): 5V AC/DC, 1 mA
 (Applicable range is subject to the operating condition and load.)

Silver Contact

| | | | | | | |
|--------------------------|----------------|----------------|------|------|------|--|
| Rated Insulation Voltage | 250V | | | | | |
| Rated Thermal Current | 5A | | | | | |
| Rated Operating Voltage | 30V | 125V | 250V | | | |
| Rated Operating Current | AC 50/60 Hz | Resistive Load | — | 3A | 2A | |
| | | Inductive Load | — | 2A | 1.5A | |
| | DC | Resistive Load | 2A | 0.4A | — | |
| | | Inductive Load | 1A | 0.2A | — | |
| Contact Material | Silver | | | | | |

AC inductive load: PF = 0.6 to 0.7, DC inductive load: L/R = 7 ms maximum

Built-in LED Lamp Ratings



| | | | | | | | |
|------------------------|--|---------------|---------|----------------------|----------------|-----|-----|
| Rated Voltage | 5V DC | 6V AC/DC | | 12V AC/DC | 24V AC/DC | | |
| Operating Voltage | 5V DC ±5% | 6V AC/DC ±10% | | 12V AC/DC ±10% | 24V AC/DC ±10% | | |
| Part No. | LFTD-5② | LFTD-6② | LFTD-1② | LFTD-2② | | | |
| Lamp Base | SX6S/8x5.4 | | | | | | |
| Current Draw | DC | A, G, PW, R | S | A, R | G, PW | S | |
| | | 8mA | 7mA | 7mA | 6mA | 8mA | 7mA |
| Lamp Base Color | AC | — | | | | | 9mA |
| | | 9mA | 10mA | 9mA | 9mA | 8mA | 9mA |
| Lamp Base Color | Same as illumination color (PW: gray) | | | | | | |
| Voltage Marking | Die stamped on the lamp base | | | | | | |
| Life (reference value) | Approx. 50,000 hours (When used on complete DC at 25°C, luminance reduces to 50% of the initial intensity.) | | | | | | |
| Internal Circuit | LFTD-5 | | | LFTD-6/LFTD-1/LFTD-2 | | | |
| | | | | | | | |

- Specify a color code in place of ② in the Part No.
 A (amber), G (green), PW (pure white), R (red), S (blue)
- Use a PW (pure white) LED lamp for yellow illumination.

Specifications

| | | |
|--|--|---|
| Operating Temperature | -25 to +55°C (no freezing) | |
| Storage Temperature | -30 to +80°C | |
| Operating Humidity | 45 to 85% RH (no condensation) | |
| Contact Resistance | 50 mΩ maximum (initial value) | |
| Insulation Resistance | 100 MΩ minimum (500V DC megger) | |
| Dielectric Strength | Switch Unit | Between live part and ground: 2,500V, 1 minute Between terminals of different poles: 2,500V, 1 minute Between terminals of the same pole: 1,000V, 1 minute |
| | Illumination Unit | Between live part and ground: 2,500V, 1 minute |
| Vibration Resistance | Operating extremes: 5 to 55 Hz, amplitude 0.5 mm | |
| Shock Resistance | Operating extremes: 100 m/s ² (10G) Damage limits: 1,000 m/s ² (100G) | |
| Mechanical Durability (minimum operations) | Momentary: | 1,000,000 |
| | Maintained: | 200,000 |
| | Selector switch: | 250,000 |
| | Key selector switch: | 250,000 |
| | Illuminated selector switch: | 250,000 |
| Electrical Durability (minimum operations) | Momentary: | 100,000 (at 1,800 operations/hour) |
| | Maintained: | 100,000 (at 1,200 operations/hour) |
| | Selector switch: | 100,000 |
| Degree of Protection | IP65 (IEC 60529) | |
| Terminal Style | Solder/tab terminal #110 PC board terminal | |
| Weight (approx.) | HA1L-M1C24: 18g HA1P-1C04: 17g HA1P-14: 13g HA1B-M1C2: 16g HA1S-2C2: 18g HA1K-2C2A: 33g HA1F-2C24: 20g | |

HA1L / HA2L Illuminated Pushbuttons

| Style | Operation | Contact Material | Operating Voltage | Contact | Part No. | | ② Illumination Color Code | |
|---|------------|-------------------|-------------------|-------------|---------------------|-------------------|--|--------------|
| | | | | | Solder/Tab Terminal | PC Board Terminal | | |
| Round HA1L  Marking plate size: ø18.4mm Engraving area: ø16.8mm (Depth: 0.5mm max.) | Momentary | Gold | 5V DC ±5% | SPDT | HA1L-M1C11② | HA1L-M1C11V② | Specify a color code in place of ② in the Part No. A: amber G: green PW: pure white R: red S: blue Y: yellow | |
| | | | | DPDT | HA1L-M1C21② | HA1L-M1C21V② | | |
| | | | 12V AC/DC ±10% | SPDT | HA1L-M1C13② | HA1L-M1C13V② | | |
| | | | | DPDT | HA1L-M1C23② | HA1L-M1C23V② | | |
| | | | 24V AC/DC ±10% | SPDT | HA1L-M1C14② | HA1L-M1C14V② | | |
| | | | | DPDT | HA1L-M1C24② | HA1L-M1C24V② | | |
| | | Silver | 5V DC ±5% | SPDT | HA1L-M1C51② | - | | |
| | | | | DPDT | HA1L-M1C61② | | | |
| | | | 12V AC/DC ±10% | SPDT | HA1L-M1C53② | | | |
| | | | | DPDT | HA1L-M1C63② | | | |
| | | | 24V AC/DC ±10% | SPDT | HA1L-M1C54② | | | |
| | | | | DPDT | HA1L-M1C64② | | | |
| | Maintained | Gold | 5V DC ±5% | SPDT | HA1L-A1C11② | | | HA1L-A1C11V② |
| | | | | DPDT | HA1L-A1C21② | | | HA1L-A1C21V② |
| | | | 12V AC/DC ±10% | SPDT | HA1L-A1C13② | | | HA1L-A1C13V② |
| | | | | DPDT | HA1L-A1C23② | | | HA1L-A1C23V② |
| | | | 24V AC/DC ±10% | SPDT | HA1L-A1C14② | | | HA1L-A1C14V② |
| | | | | DPDT | HA1L-A1C24② | | | HA1L-A1C24V② |
| | | Silver | 5V DC ±5% | SPDT | HA1L-A1C51② | - | | |
| | | | | DPDT | HA1L-A1C61② | | | |
| | | | 12V AC/DC ±10% | SPDT | HA1L-A1C53② | | | |
| | | | | DPDT | HA1L-A1C63② | | | |
| | | | 24V AC/DC ±10% | SPDT | HA1L-A1C54② | | | |
| | | | | DPDT | HA1L-A1C64② | | | |
| Square HA2L  Marking plate size: □18.4mm Engraving area: □16.4mm (Depth: 0.5mm max.) | Momentary | Gold | 5V DC ±5% | SPDT | HA2L-M1C11② | | HA2L-M1C11V② | |
| | | | | DPDT | HA2L-M1C21② | | HA2L-M1C21V② | |
| | | | 12V AC/DC ±10% | SPDT | HA2L-M1C13② | | HA2L-M1C13V② | |
| | | | | DPDT | HA2L-M1C23② | | HA2L-M1C23V② | |
| | | | 24V AC/DC ±10% | SPDT | HA2L-M1C14② | | HA2L-M1C14V② | |
| | | | | DPDT | HA2L-M1C24② | | HA2L-M1C24V② | |
| | | Silver | 5V DC ±5% | SPDT | HA2L-M1C51② | - | | |
| | | | | DPDT | HA2L-M1C61② | | | |
| | | | 12V AC/DC ±10% | SPDT | HA2L-M1C53② | | | |
| | | | | DPDT | HA2L-M1C63② | | | |
| | | | 24V AC/DC ±10% | SPDT | HA2L-M1C54② | | | |
| | | | | DPDT | HA2L-M1C64② | | | |
| Maintained | Gold | 5V DC ±5% | SPDT | HA2L-A1C11② | HA2L-A1C11V② | | | |
| | | | DPDT | HA2L-A1C21② | HA2L-A1C21V② | | | |
| | | 12V AC/DC ±10% | SPDT | HA2L-A1C13② | HA2L-A1C13V② | | | |
| | | | DPDT | HA2L-A1C23② | HA2L-A1C23V② | | | |
| | | 24V AC/DC ±10% | SPDT | HA2L-A1C14② | HA2L-A1C14V② | | | |
| | | | DPDT | HA2L-A1C24② | HA2L-A1C24V② | | | |
| | Silver | 5V DC ±5% | SPDT | HA2L-A1C51② | - | | | |
| | | | DPDT | HA2L-A1C61② | | | | |
| | | 12V AC/DC ±10% | SPDT | HA2L-A1C53② | | | | |
| | | | DPDT | HA2L-A1C63② | | | | |
| | | 24V AC/DC ±10% | SPDT | HA2L-A1C54② | | | | |
| | | | DPDT | HA2L-A1C64② | | | | |

- See page 24 for marking plate size and engraving area.
- One LED lamp is installed in an illuminated pushbutton.

HA3L / HA4L / HA1L-M3 / A3 Illuminated Pushbuttons

| Style | Operation | Contact Material | Operating Voltage | Contact | Part No. | | ② Illumination Color Code |
|--|--|-------------------|-------------------|-------------------|---------------------|-------------------|--|
| | | | | | Solder/Tab Terminal | PC Board Terminal | |
| Round w/Square Bezel HA3L  <p>Marking plate size: ø18.4mm Engraving area: ø16.8mm (Depth: 0.5mm max.)</p> | Momentary | Gold | 5V DC ±5% | SPDT | HA3L-M1C11② | HA3L-M1C11V② | Specify a color code in place of ② in the Part No. A: amber G: green PW: pure white R: red S: blue Y: yellow |
| | | | | DPDT | HA3L-M1C21② | HA3L-M1C21V② | |
| | | | 12V AC/DC ±10% | SPDT | HA3L-M1C13② | HA3L-M1C13V② | |
| | | DPDT | | HA3L-M1C23② | HA3L-M1C23V② | | |
| | | 24V AC/DC ±10% | SPDT | HA3L-M1C14② | HA3L-M1C14V② | | |
| | | | DPDT | HA3L-M1C24② | HA3L-M1C24V② | | |
| | Silver | 5V DC ±5% | SPDT | HA3L-M1C51② | - | | |
| | | | DPDT | HA3L-M1C61② | | | |
| | | 12V AC/DC ±10% | SPDT | HA3L-M1C53② | | | |
| | DPDT | | HA3L-M1C63② | | | | |
| | 24V AC/DC ±10% | SPDT | HA3L-M1C54② | | | | |
| | | DPDT | HA3L-M1C64② | | | | |
| | Maintained | Gold | 5V DC ±5% | SPDT | HA3L-A1C11② | HA3L-A1C11V② | |
| | | | | DPDT | HA3L-A1C21② | HA3L-A1C21V② | |
| | | | 12V AC/DC ±10% | SPDT | HA3L-A1C13② | HA3L-A1C13V② | |
| | | DPDT | | HA3L-A1C23② | HA3L-A1C23V② | | |
| | | 24V AC/DC ±10% | SPDT | HA3L-A1C14② | HA3L-A1C14V② | | |
| | | | DPDT | HA3L-A1C24② | HA3L-A1C24V② | | |
| Silver | 5V DC ±5% | SPDT | HA3L-A1C51② | - | | | |
| | | DPDT | HA3L-A1C61② | | | | |
| | 12V AC/DC ±10% | SPDT | HA3L-A1C53② | | | | |
| DPDT | | HA3L-A1C63② | | | | | |
| 24V AC/DC ±10% | SPDT | HA3L-A1C54② | | | | | |
| | DPDT | HA3L-A1C64② | | | | | |
| Square w/Four-sided Barrier HA4L  <p>Marking plate size: □18.4mm Engraving area: □16.4mm (Depth: 0.5mm max.)</p> | Momentary | Gold | 5V DC ±5% | SPDT | HA4L-M1C11② | HA4L-M1C11V② | |
| | | | | DPDT | HA4L-M1C21② | HA4L-M1C21V② | |
| | | | 12V AC/DC ±10% | SPDT | HA4L-M1C13② | HA4L-M1C13V② | |
| | | DPDT | | HA4L-M1C23② | HA4L-M1C23V② | | |
| | | 24V AC/DC ±10% | SPDT | HA4L-M1C14② | HA4L-M1C14V② | | |
| | | | DPDT | HA4L-M1C24② | HA4L-M1C24V② | | |
| | Silver | 5V DC ±5% | SPDT | HA4L-M1C51② | - | | |
| | | | DPDT | HA4L-M1C61② | | | |
| | | 12V AC/DC ±10% | SPDT | HA4L-M1C53② | | | |
| | DPDT | | HA4L-M1C63② | | | | |
| | 24V AC/DC ±10% | SPDT | HA4L-M1C54② | | | | |
| | | DPDT | HA4L-M1C64② | | | | |
| | ø30 Mushroom HA1L-□3  <p>Marking plate size: ø14.8mm Engraving area: ø12.8mm (Depth: 0.5mm max.)</p> | Momentary | Gold | 5V DC ±5% | SPDT | HA1L-M3C11② | HA1L-M3C11V② |
| | | | | | DPDT | HA1L-M3C21② | HA1L-M3C21V② |
| | | | | 12V AC/DC ±10% | SPDT | HA1L-M3C13② | HA1L-M3C13V② |
| | | | DPDT | | HA1L-M3C23② | HA1L-M3C23V② | |
| | | | 24V AC/DC ±10% | SPDT | HA1L-M3C14② | HA1L-M3C14V② | |
| | | | | DPDT | HA1L-M3C24② | HA1L-M3C24V② | |
| Silver | | 5V DC ±5% | SPDT | HA1L-M3C51② | - | | |
| | | | DPDT | HA1L-M3C61② | | | |
| | | 12V AC/DC ±10% | SPDT | HA1L-M3C53② | | | |
| DPDT | | | HA1L-M3C63② | | | | |
| 24V AC/DC ±10% | | SPDT | HA1L-M3C54② | | | | |
| | | DPDT | HA1L-M3C64② | | | | |
| Maintained | Gold | 5V DC ±5% | SPDT | HA1L-A3C11② | HA1L-A3C11V② | | |
| | | | DPDT | HA1L-A3C21② | HA1L-A3C21V② | | |
| | | 12V AC/DC ±10% | SPDT | HA1L-A3C13② | HA1L-A3C13V② | | |
| | DPDT | | HA1L-A3C23② | HA1L-A3C23V② | | | |
| | 24V AC/DC ±10% | SPDT | HA1L-A3C14② | HA1L-A3C14V② | | | |
| | | DPDT | HA1L-A3C24② | HA1L-A3C24V② | | | |
| Silver | 5V DC ±5% | SPDT | HA1L-A3C51② | - | | | |
| | | DPDT | HA1L-A3C61② | | | | |
| | 12V AC/DC ±10% | SPDT | HA1L-A3C53② | | | | |
| DPDT | | HA1L-A3C63② | | | | | |
| 24V AC/DC ±10% | SPDT | HA1L-A3C54② | | | | | |
| | DPDT | HA1L-A3C64② | | | | | |

• See page 24 for marking plate size and engraving area. • One LED lamp is installed in an illuminated pushbutton.

Dimensions

All dimensions in mm.

Round
Square
Round w/Square
Bezel

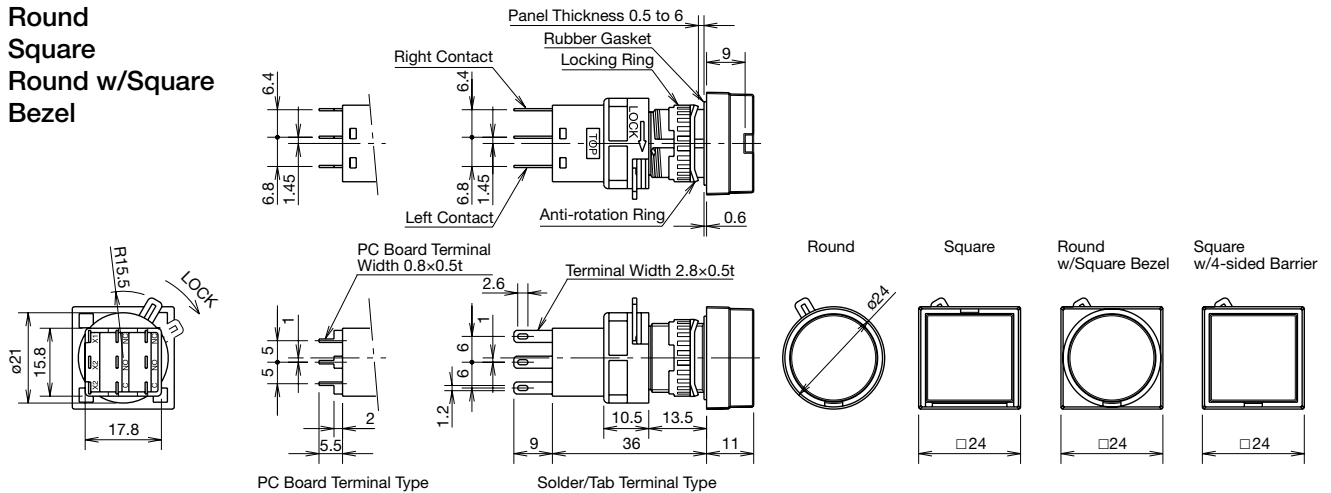

Mushroom

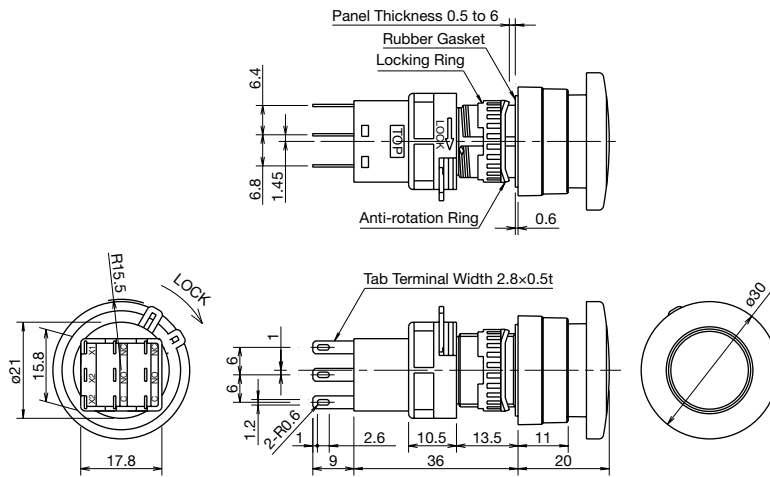

Mounting Hole Layout
Mounting Centers

Round
Square
Round w/Square Bezel

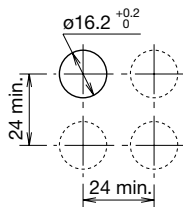

PC Board Drilling Layout
(Bottom View)

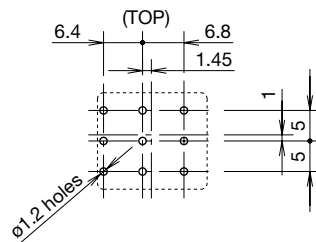

• See Single Board Mounting on page 24 for details about PC boards.

Terminal Arrangement
(Bottom View)

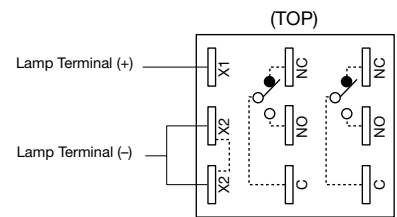

- SPDT has C, NO, and NC on the right only.
- X2 and X2 are wired internally.



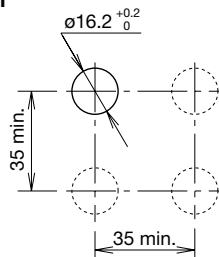

Mushroom



Note: Determine mounting centers to ensure easy operation.





HA1P / HA2P / HA3P / HA4P Pilot Lights

W/Removable Contact Block

| Shape | Operating Voltage | Part No. | | ② Illumination Color Code |
|--|-------------------|---------------------|-------------------|--|
| | | Solder/Tab Terminal | PC Board Terminal | |
| Round HA1P  Marking plate size: ø18.4mm Engraving area: ø16.8mm (Depth: 0.5mm max.) | 5V DC ±5% | HA1P-1C01② | HA1P-1C01V② | Specify a color code in place of ② in the Part No. A: amber G: green PW: pure white R: red S: blue Y: yellow |
| | 12V AC/DC ±10% | HA1P-1C03② | HA1P-1C03V② | |
| | 24V AC/DC ±10% | HA1P-1C04② | HA1P-1C04V② | |
| Square HA2P  Marking plate size: □18.4mm Engraving area: □16.4mm (Depth: 0.5mm max.) | 5V DC ±5% | HA2P-1C01② | HA2P-1C01V② | |
| | 12V AC/DC ±10% | HA2P-1C03② | HA2P-1C03V② | |
| | 24V AC/DC ±10% | HA2P-1C04② | HA2P-1C04V② | |
| Round w/Square Bezel HA3P  Marking plate size: ø18.4mm Engraving area: ø16.8mm (Depth: 0.5mm max.) | 5V DC ±5% | HA3P-1C01② | HA3P-1C01V② | |
| | 12V AC/DC ±10% | HA3P-1C03② | HA3P-1C03V② | |
| | 24V AC/DC ±10% | HA3P-1C04② | HA3P-1C04V② | |
| Square w/Four-sided Barrier HA4P  Marking plate size: □18.4mm Engraving area: □16.4mm (Depth: 0.5mm max.) | 5V DC ±5% | HA4P-1C01② | HA4P-1C01V② | |
| | 12V AC/DC ±10% | HA4P-1C03② | HA4P-1C03V② | |
| | 24V AC/DC ±10% | HA4P-1C04② | HA4P-1C04V② | |

- See page 6 for dimensions. • See page 24 for marking plate size and engraving area.
- One LED lamp is installed in an illuminated pilot light.

Unibody

| Shape | Operating Voltage | Part No. | | ② Illumination Color Code |
|--|-------------------|---------------------|-------------------|--|
| | | Solder/Tab Terminal | PC Board Terminal | |
| Round HA1P  Marking plate size: ø18.4mm Engraving area: ø16.8mm (Depth: 0.5mm max.) | 5V DC ±5% | HA1P-11② | — | Specify a color code in place of ② in the Part No. A: amber G: green PW: pure white R: red S: blue Y: yellow |
| | 12V AC/DC ±10% | HA1P-13② | — | |
| | 24V AC/DC ±10% | HA1P-14② | — | |
| Square HA2P  Marking plate size: □18.4mm Engraving area: □16.4mm (Depth: 0.5mm max.) | 5V DC ±5% | HA2P-11② | — | |
| | 12V AC/DC ±10% | HA2P-13② | — | |
| | 24V AC/DC ±10% | HA2P-14② | — | |
| Round w/Square Bezel HA3P  Marking plate size: ø18.4mm Engraving area: ø16.8mm (Depth: 0.5mm max.) | 5V DC ±5% | HA3P-11② | — | |
| | 12V AC/DC ±10% | HA3P-13② | — | |
| | 24V AC/DC ±10% | HA3P-14② | — | |
| Square w/Four-sided Barrier HA4P  Marking plate size: □18.4mm Engraving area: □16.4mm (Depth: 0.5mm max.) | 5V DC ±5% | HA4P-11② | — | |
| | 12V AC/DC ±10% | HA4P-13② | — | |
| | 24V AC/DC ±10% | HA4P-14② | — | |

- See page 6 for dimensions. • See page 24 for marking plate size and engraving area.
- One LED lamp is installed in an illuminated pilot light.

Dimensions

All dimensions in mm.

W/Removable Contact Block

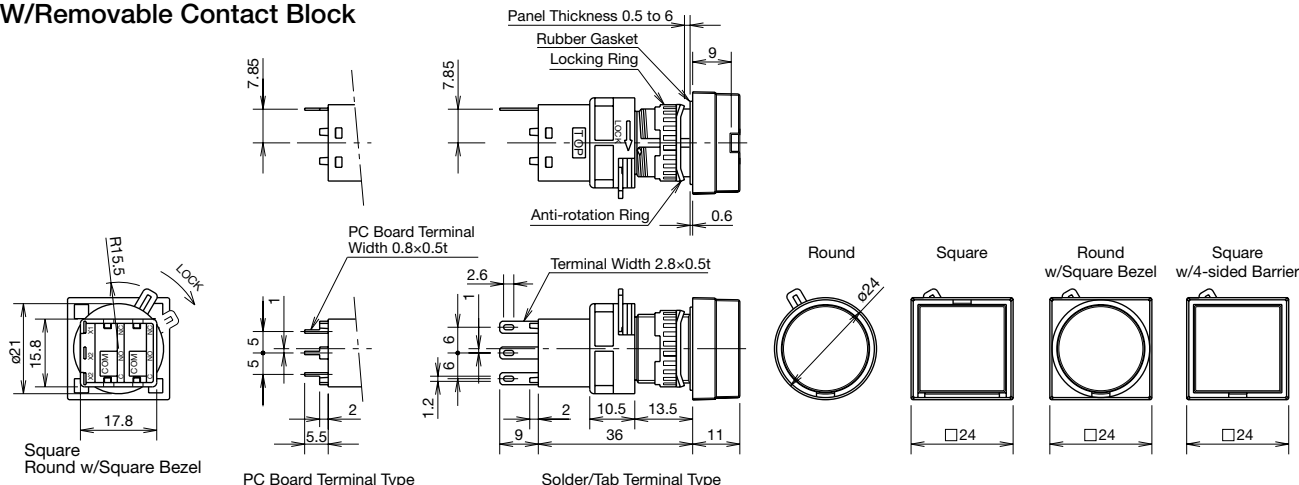

Unibody

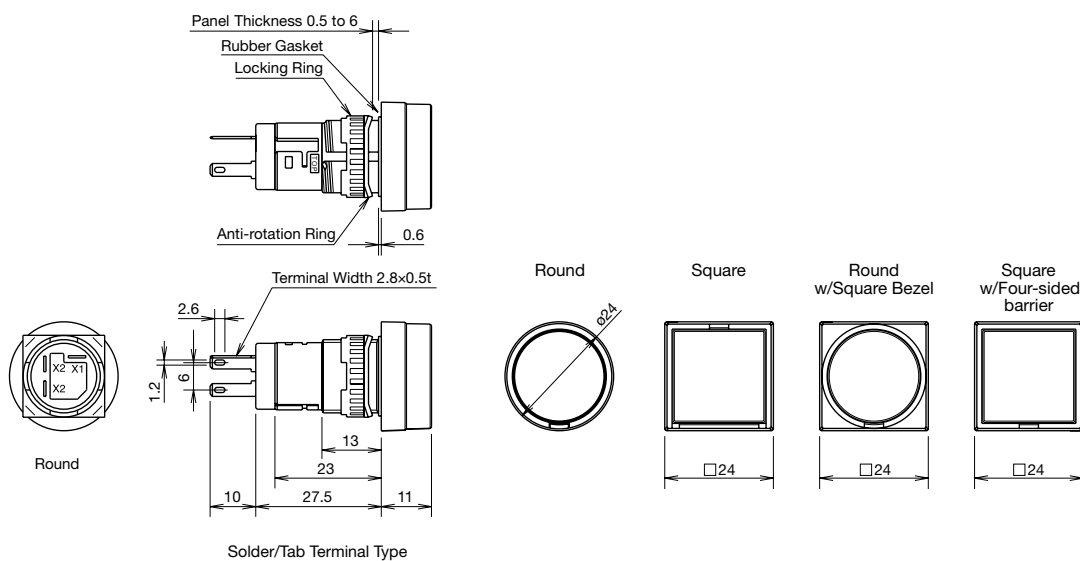

Mounting Hole Layout
Mounting Centers

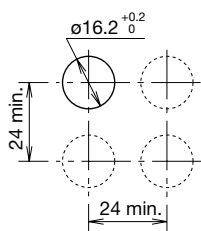

PC Board Drilling Layout
(Bottom View)

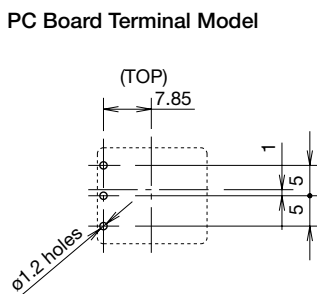



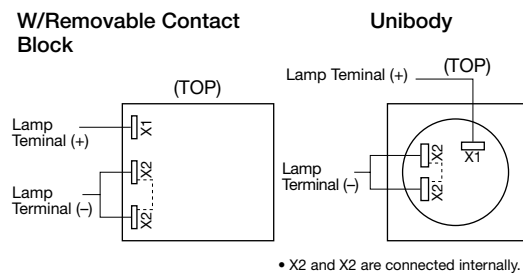

• See Single Board Mounting on page 24 for details about PC boards.

Terminal Arrangement
(Bottom View)







• X2 and X2 are connected internally.

HA1B / HA2B / HA3B / HA4B Pushbuttons

| Shape | Button Style | Operation | Contact | Part No. | | Color Code ①② | | |
|--|---|-------------|-------------|---------------------|-------------------|---------------|--|--|
| | | | | Solder/Tab Terminal | PC Board Terminal | | | |
| Round HA1B-□1  | Button | Momentary | Gold | SPDT | HA1B-M1C1① | HA1B-M1C1V① | B: black G: green R: red S: blue W: white Y: yellow | |
| | | | | DPDT | HA1B-M1C2① | HA1B-M1C2V① | | |
| | | | Silver | SPDT | HA1B-M1C5① | — | | |
| | | DPDT | | HA1B-M1C6① | — | | | |
| | | Maintained | Gold | SPDT | HA1B-A1C1① | HA1B-A1C1V① | | |
| | | | | DPDT | HA1B-A1C2① | HA1B-A1C2V① | | |
| | Silver | | SPDT | HA1B-A1C5① | — | | | |
| | | DPDT | HA1B-A1C6① | — | | | | |
| | Illumination Lens | Momentary | Gold | SPDT | HA1B-M1C1L② | HA1B-M1C1VL② | A: amber G: green R: red S: blue W: white Y: yellow | |
| | | | | DPDT | HA1B-M1C2L② | HA1B-M1C2VL② | | |
| | | | Silver | SPDT | HA1B-M1C5L② | — | | |
| | | DPDT | | HA1B-M1C6L② | — | | | |
| | | Maintained | Gold | SPDT | HA1B-A1C1L② | HA1B-A1C1VL② | | |
| | | | | DPDT | HA1B-A1C2L② | HA1B-A1C2VL② | | |
| | Silver | | SPDT | HA1B-A1C5L② | — | | | |
| | | DPDT | HA1B-A1C6L② | — | | | | |
| | Square HA2B-□1  | Button | Momentary | Gold | SPDT | HA2B-M1C1① | HA2B-M1C1V① | B: black G: green R: red S: blue W: white Y: yellow |
| | | | | | DPDT | HA2B-M1C2① | HA2B-M1C2V① | |
| Silver | | | | SPDT | HA2B-M1C5① | — | | |
| | | | DPDT | HA2B-M1C6① | — | | | |
| Maintained | | | Gold | SPDT | HA2B-A1C1① | HA2B-A1C1V① | | |
| | | | | DPDT | HA2B-A1C2① | HA2B-A1C2V① | | |
| | | Silver | SPDT | HA2B-A1C5① | — | | | |
| DPDT | | | HA2B-A1C6① | — | | | | |
| Illumination Lens | | Momentary | Gold | SPDT | HA2B-M1C1L② | HA2B-M1C1VL② | A: amber G: green R: red S: blue W: white Y: yellow | |
| | | | | DPDT | HA2B-M1C2L② | HA2B-M1C2VL② | | |
| | | | Silver | SPDT | HA2B-M1C5L② | — | | |
| | | DPDT | | HA2B-M1C6L② | — | | | |
| | | Maintained | Gold | SPDT | HA2B-A1C1L② | HA2B-A1C1VL② | | |
| | | | | DPDT | HA2B-A1C2L② | HA2B-A1C2VL② | | |
| Silver | | | SPDT | HA2B-A1C5L② | — | | | |
| | | DPDT | HA2B-A1C6L② | — | | | | |
| Round w/Square Bezel HA3B-□1  | | Button | Momentary | Gold | SPDT | HA3B-M1C1① | HA3B-M1C1V① | B: black G: green R: red S: blue W: white Y: yellow |
| | | | | | DPDT | HA3B-M1C2① | HA3B-M1C2V① | |
| | Silver | | | SPDT | HA3B-M1C5① | — | | |
| | | | DPDT | HA3B-M1C6① | — | | | |
| | Maintained | | Gold | SPDT | HA3B-A1C1① | HA3B-A1C1V① | | |
| | | | | DPDT | HA3B-A1C2① | HA3B-A1C2V① | | |
| | | Silver | SPDT | HA3B-A1C5① | — | | | |
| | DPDT | | HA3B-A1C6① | — | | | | |
| | Illumination Lens | Momentary | Gold | SPDT | HA3B-M1C1L② | HA3B-M1C1VL② | A: amber G: green R: red S: blue W: white Y: yellow | |
| | | | | DPDT | HA3B-M1C2L② | HA3B-M1C2VL② | | |
| | | | Silver | SPDT | HA3B-M1C5L② | — | | |
| | | DPDT | | HA3B-M1C6L② | — | | | |
| | | Maintained | Gold | SPDT | HA3B-A1C1L② | HA3B-A1C1VL② | | |
| | | | | DPDT | HA3B-A1C2L② | HA3B-A1C2VL② | | |
| | Silver | | SPDT | HA3B-A1C5L② | — | | | |
| | | DPDT | HA3B-A1C6L② | — | | | | |
| | Square w/Four-sided Barrier HA4B-M1  | Button | Momentary | Gold | SPDT | HA4B-M1C1① | HA4B-M1C1V① | B: black G: green R: red S: blue W: white Y: yellow |
| | | | | | DPDT | HA4B-M1C2① | HA4B-M1C2V① | |
| Silver | | | | SPDT | HA4B-M1C5① | — | | |
| | | DPDT | HA4B-M1C6① | — | | | | |
| Illumination Lens | | Maintained | Gold | SPDT | HA4B-M1C1L② | HA4B-M1C1VL② | A: amber G: green R: red S: blue W: white Y: yellow | |
| | | | | DPDT | HA4B-M1C2L② | HA4B-M1C2VL② | | |
| | Silver | | SPDT | HA4B-M1C5L② | — | | | |
| DPDT | | HA4B-M1C6L② | — | | | | | |

- Specify a color code in place of ① or ② in the Part No. • For dimensions, see page 9.
- Illuminated lenses cannot be installed on button type pushbuttons.
- Black lens type is available for illumination lens type (not CCC approved). Clear lens and black marking plate are used. To specify, insert B in place of ② in the part number. Example: HA1B-M1C2LB.

HA1B / HA2B / HA3B / HA4B Pushbuttons

| Shape | Button Style | Operation | Contact | Part No. | | Color Code ① | |
|---|--------------|------------|------------|---------------------|-------------------|--------------|--|
| | | | | Solder/Tab Terminal | PC Board Terminal | | |
| Extended Round HA1B-□2  Square HA2B-□2  Round w/Square Bezel HA3B-□2  Square w/Four-sided Barrier HA4B-M2  | Button | Momentary | Gold | SPDT | HA1B-M2C1① | HA1B-M2C1V① | B: black G: green R: red S: blue W: white Y: yellow |
| | | | | DPDT | HA1B-M2C2① | HA1B-M2C2V① | |
| | | | Silver | SPDT | HA1B-M2C5① | — | |
| | | | | DPDT | HA1B-M2C6① | — | |
| | | Maintained | Gold | SPDT | HA1B-A2C1① | HA1B-A2C1V① | |
| | | | | DPDT | HA1B-A2C2① | HA1B-A2C2V① | |
| | | | Silver | SPDT | HA1B-A2C5① | — | |
| | | | | DPDT | HA1B-A2C6① | — | |
| | | Momentary | Gold | SPDT | HA2B-M2C1① | HA2B-M2C1V① | |
| | | | | DPDT | HA2B-M2C2① | HA2B-M2C2V① | |
| | | | Silver | SPDT | HA2B-M2C5① | — | |
| | | | | DPDT | HA2B-M2C6① | — | |
| | | Maintained | Gold | SPDT | HA2B-A2C1① | HA2B-A2C1V① | |
| | | | | DPDT | HA2B-A2C2① | HA2B-A2C2V① | |
| | | | Silver | SPDT | HA2B-A2C5① | — | |
| | | | | DPDT | HA2B-A2C6① | — | |
| Momentary | Gold | SPDT | HA3B-M2C1① | HA3B-M2C1V① | | | |
| | | DPDT | HA3B-M2C2① | HA3B-M2C2V① | | | |
| | Silver | SPDT | HA3B-M2C5① | — | | | |
| | | DPDT | HA3B-M2C6① | — | | | |
| Maintained | Gold | SPDT | HA3B-A2C1① | HA3B-A2C1V① | | | |
| | | DPDT | HA3B-A2C2① | HA3B-A2C2V① | | | |
| | Silver | SPDT | HA3B-A2C5① | — | | | |
| | | DPDT | HA3B-A2C6① | — | | | |
| ø30mm Mushroom Round HA1B-□3  | Button | Momentary | Gold | SPDT | HA1B-M3C1① | HA1B-M3C1V① | |
| | | | | DPDT | HA1B-M3C2① | HA1B-M3C2V① | |
| | | | Silver | SPDT | HA1B-M3C5① | — | |
| | | | | DPDT | HA1B-M3C6① | — | |
| | | Maintained | Gold | SPDT | HA1B-A3C1① | HA1B-A3C1V① | |
| | | | | DPDT | HA1B-A3C2① | HA1B-A3C2V① | |
| | | | Silver | SPDT | HA1B-A3C5① | — | |
| | | | | DPDT | HA1B-A3C6① | — | |

- Specify a color code in place of ① in the Part No.
- For dimensions, see page 9.

Dimensions

All dimensions in mm.

Flush

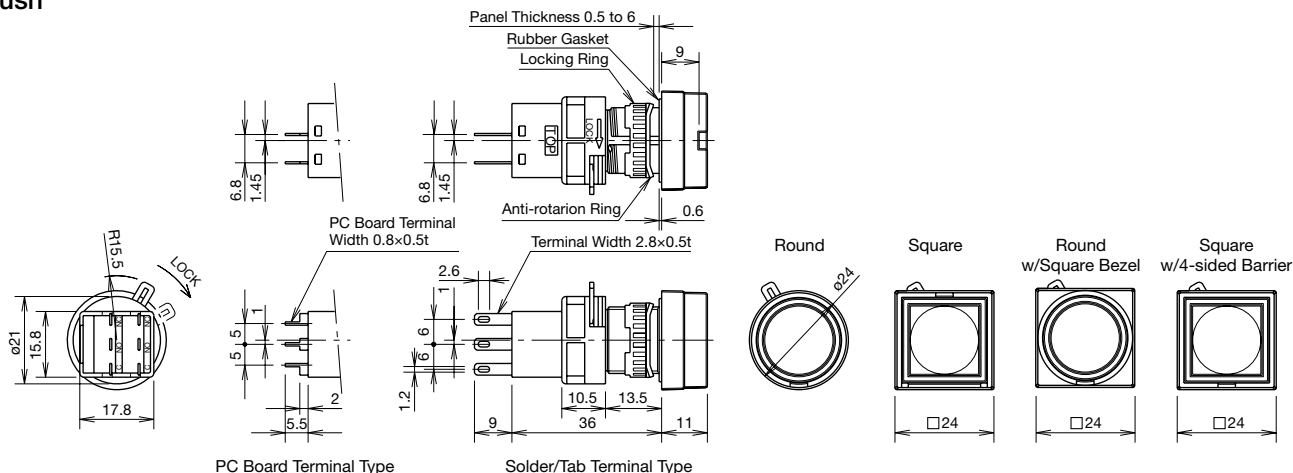

Extended

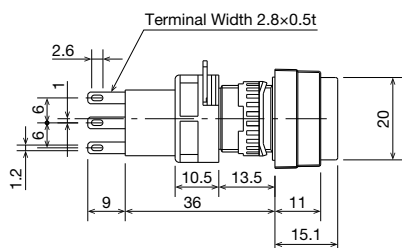

ø30mm Mushroom

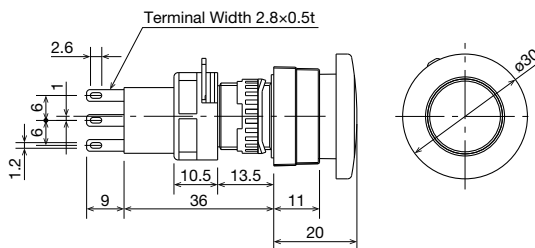

Mounting Hole Layout
Mounting Centers

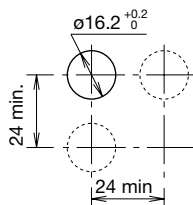

* 35 min. for mushroom type

PC Board Drilling Layout
(Bottom View)

PC Board Terminal Model

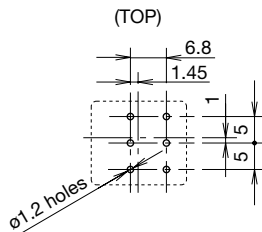

Terminal Arrangement
(Bottom View)

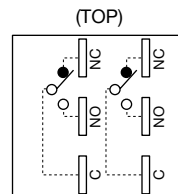







• SPDT has C, NO, and NC on the right only.

Note: Determine mounting centers to ensure easy operation.



















• See Single Board Mounting on page 24 for details about PC boards.

HA1S / HA3S Selector Switches

| Shape | Operator Position | | Operation | Contact | | Part No. | |
|---|-------------------|--------------------------|---|-----------|------------|---------------------|-------------------|
| | | | | | | Solder/Tab Terminal | PC Board Terminal |
| Round HA1S  | 90° 2-position | Maintained |  | Gold | SPDT | HA1S-2C1 | HA1S-2C1V |
| | | | | | DPDT | HA1S-2C2 | HA1S-2C2V |
| | | | | Silver | SPDT | HA1S-2C5 | — |
| | | DPDT | HA1S-2C6 | | — | | |
| | | Spring return from right | Gold | SPDT | HA1S-21C1 | HA1S-21C1V | |
| | | | | DPDT | HA1S-21C2 | HA1S-21C2V | |
| | Silver | | SPDT | HA1S-21C5 | — | | |
| | | DPDT | HA1S-21C6 | — | | | |
| | 45° 3-position | Maintained |  | Gold | DPDT | HA1S-3C2 | HA1S-3C2V |
| | | | | | Silver | DPDT | HA1S-3C6 |
| | | Spring return from right | Gold | DPDT | HA1S-31C2 | HA1S-31C2V | |
| | | | | Silver | DPDT | HA1S-31C6 | — |
| Spring return from left | | Gold | DPDT | HA1S-32C2 | HA1S-32C2V | | |
| | | | Silver | DPDT | HA1S-32C6 | — | |
| Spring return two-way | | Gold | DPDT | HA1S-33C2 | HA1S-33C2V | | |
| | | | Silver | DPDT | HA1S-33C6 | — | |
| Round w/Square Bezel HA3S  | 90° 2-position | Maintained |  | Gold | SPDT | HA3S-2C1 | HA3S-2C1V |
| | | | | | DPDT | HA3S-2C2 | HA3S-2C2V |
| | | | | Silver | SPDT | HA3S-2C5 | — |
| | | DPDT | HA3S-2C6 | | — | | |
| | | Spring return from right | Gold | SPDT | HA3S-21C1 | HA3S-21C1V | |
| | | | | DPDT | HA3S-21C2 | HA3S-21C2V | |
| | Silver | | SPDT | HA3S-21C5 | — | | |
| | | DPDT | HA3S-21C6 | — | | | |
| | 45° 3-position | Maintained |  | Gold | DPDT | HA3S-3C2 | HA3S-3C2V |
| | | | | | Silver | DPDT | HA3S-3C6 |
| | | Spring return from right | Gold | DPDT | HA3S-31C2 | HA3S-31C2V | |
| | | | | Silver | DPDT | HA3S-31C6 | — |
| Spring return from left | | Gold | DPDT | HA3S-32C2 | HA3S-32C2V | | |
| | | | Silver | DPDT | HA3S-32C6 | — | |
| Spring return two-way | | Gold | DPDT | HA3S-33C2 | HA3S-33C2V | | |
| | | | Silver | DPDT | HA3S-33C6 | — | |

- Bezel: black
- Knob: black with white indicator
- See page 11 for dimensions.

Contact Operation

| Operator Position & Contact Operation (Top View) | | | | | |
|--|---|---------|--|---|---|
| Positions | | Contact | ↙ Left | ↑ Center | ↘ Right |
| 90° 2-position |  Maintained  Spring return from right | SPDT |  | — |  |
| | | DPDT | Left Contact:  NO NC Right Contact:  NO NC | — | Left Contact:  NO NC Right Contact:  NO NC |
| 45° 3-position |  Maintained  Spring return from right  Spring return from left  Spring return two-way | DPDT | Left Contact:  NO NC Right Contact:  NO NC | Left Contact:  NO NC Right Contact:  NO NC | Left Contact:  NO NC Right Contact:  NO NC |

Dimensions

All dimensions in mm.

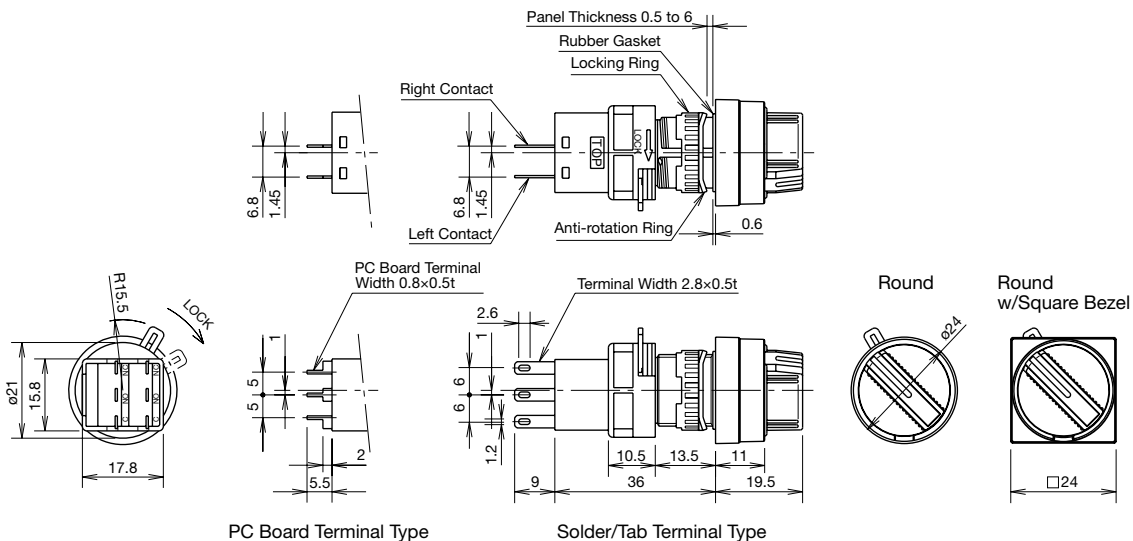

Mounting Hole Layout
 Mounting Centers

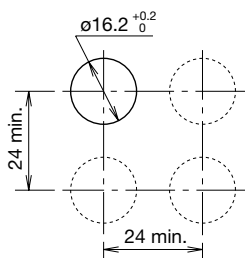

Note: Determine mounting centers to ensure easy operation.

PC Board Drilling Layout
 (Bottom View)

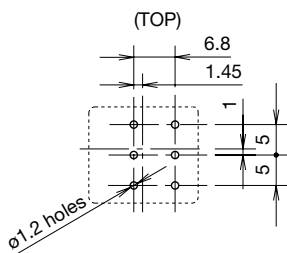





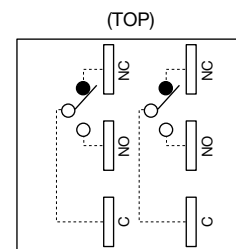













• See Single Board Mounting on page 24 for details about PC boards.

Terminal Arrangement
 (Bottom View)













• SPDT has C, NO, and NC on the right only.

HA1K Key Selector Switches

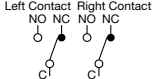
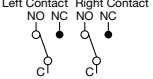

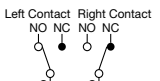
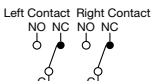
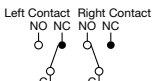















| Shape | Operator Position | | Keys Retained at ● | Contact | Part No. | | | |
|--|---|---|---|-------------|---------------------|-------------------|-------------|---|
| | | | | | Solder/Tab Terminal | PC Board Terminal | | |
| Round HA1K  | 90° 2-position | Maintained | A  | Gold | SPDT | HA1K-2C1A | HA1K-2C1VA | |
| | | | | | DPDT | HA1K-2C2A | HA1K-2C2VA | |
| | | | Silver | SPDT | HA1K-2C5A | — | | |
| | | | | DPDT | HA1K-2C6A | — | | |
| | | | B  | Gold | SPDT | HA1K-2C1B | HA1K-2C1VB | |
| | | | | | DPDT | HA1K-2C2B | HA1K-2C2VB | |
| | | Silver | SPDT | HA1K-2C5B | — | | | |
| | | | DPDT | HA1K-2C6B | — | | | |
| | | C  | Gold | SPDT | HA1K-2C1C | HA1K-2C1VC | | |
| | | | | DPDT | HA1K-2C2C | HA1K-2C2VC | | |
| | | Silver | SPDT | HA1K-2C5C | — | | | |
| | | | DPDT | HA1K-2C6C | — | | | |
| | | Spring return from right | B  | Gold | SPDT | HA1K-21C1B | HA1K-21C1VB | |
| | | | | | DPDT | HA1K-21C2B | HA1K-21C2VB | |
| | | | | | Silver | SPDT | HA1K-21C5B | — |
| | | | | | | DPDT | HA1K-21C6B | — |
| | 45° 3-position | Maintained | A  | Gold | DPDT | HA1K-3C2A | HA1K-3C2VA | |
| | | | | | Silver | DPDT | HA1K-3C6A | — |
| | | | B  | Gold | DPDT | HA1K-3C2B | HA1K-3C2VB | |
| | | | | | Silver | DPDT | HA1K-3C6B | — |
| | | | C  | Gold | DPDT | HA1K-3C2C | HA1K-3C2VC | |
| | | | | | Silver | DPDT | HA1K-3C6C | — |
| | | | D  | Gold | DPDT | HA1K-3C2D | HA1K-3C2VD | |
| | | | | | Silver | DPDT | HA1K-3C6D | — |
| | | | E  | Gold | DPDT | HA1K-3C2E | HA1K-3C2VE | |
| | | | | | Silver | DPDT | HA1K-3C6E | — |
| | | | G  | Gold | DPDT | HA1K-3C2G | HA1K-3C2VG | |
| | | | | | Silver | DPDT | HA1K-3C6G | — |
| | | H  | Gold | DPDT | HA1K-3C2H | HA1K-3C2VH | | |
| | | | | Silver | DPDT | HA1K-3C6H | — | |
| | | Spring return from right | B  | Gold | DPDT | HA1K-31C2B | HA1K-31C2VB | |
| | | | | | Silver | DPDT | HA1K-31C6B | — |
| | | | D  | Gold | DPDT | HA1K-31C2D | HA1K-31C2VD | |
| | | | | | Silver | DPDT | HA1K-31C6D | — |
| | | G  | Gold | DPDT | HA1K-31C2G | HA1K-31C2VG | | |
| | | | | Silver | DPDT | HA1K-31C6G | — | |
| | | Spring return from left | C  | Gold | DPDT | HA1K-32C2C | HA1K-32C2VC | |
| | | | | | Silver | DPDT | HA1K-32C6C | — |
| | | | D  | Gold | DPDT | HA1K-32C2D | HA1K-32C2VD | |
| | | | | | Silver | DPDT | HA1K-32C6D | — |
| H  | Gold | DPDT | HA1K-32C2H | HA1K-32C2VH | | | | |
| | | Silver | DPDT | HA1K-32C6H | — | | | |
| Spring return two-way | D  | Gold | DPDT | HA1K-33C2D | HA1K-33C2VD | | | |
| | | | Silver | DPDT | HA1K-33C6D | — | | |

- Two keys are supplied.
- The front of key cylinder is made of black plastic.
- See page 14 for dimensions.
- Besides the standard key (key number 231), three other key numbers are available (2/3/5). To specify, add the key number in the part number as: HA1K-3C2A-2

Contact Operation













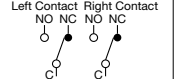
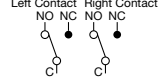

| Operator Position & Contact Operation (Top View) | | | | | |
|--|--|---------|--|---|---|
| Positions | | Contact | ← Left | ↑ Center | → Right |
| 90° 2-position | Maintained  | SPDT |  | — |  |
| | Spring return from right  | DPDT |  | — |  |
| 45° 3-position | Maintained  | DPDT |  |  |  |
| | Spring return from right  | | | | |
| | Spring return from left  | | | | |
| | Spring return two-way  | | | | |

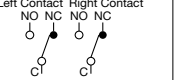
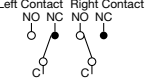
HA3K Key Selector Switches

| Shape | Operator Position | Keys Retained at ● | Contact | Part No. | | | | | | |
|--|---|---|---|---------------------|-------------------|---|-------------|------|-----------|------------|
| | | | | Solder/Tab Terminal | PC Board Terminal | | | | | |
| Round w/Square Bezel HA3K  | 90° 2-position | Maintained | A  | Gold | SPDT | HA3K-2C1A | HA3K-2C1VA | | | |
| | | | | Silver | DPDT | HA3K-2C2A | HA3K-2C2VA | | | |
| | | | B  | Gold | SPDT | HA3K-2C1B | HA3K-2C1VB | | | |
| | | | | Silver | DPDT | HA3K-2C2B | HA3K-2C2VB | | | |
| | | | C  | Gold | SPDT | HA3K-2C1C | HA3K-2C1VC | | | |
| | | | | Silver | DPDT | HA3K-2C2C | HA3K-2C2VC | | | |
| | | Spring return from right | B  | Gold | SPDT | HA3K-21C1B | HA3K-21C1VB | | | |
| | | | | Silver | DPDT | HA3K-21C2B | HA3K-21C2VB | | | |
| | | | | Gold | SPDT | HA3K-21C5B | — | | | |
| | | | | Silver | DPDT | HA3K-21C6B | — | | | |
| | | | | 45° 3-position | Maintained | A  | Gold | DPDT | HA3K-3C2A | HA3K-3C2VA |
| | | | | | | | Silver | DPDT | HA3K-3C6A | — |
| | B  | Gold | DPDT | | | HA3K-3C2B | HA3K-3C2VB | | | |
| | | Silver | DPDT | | | HA3K-3C6B | — | | | |
| | C  | Gold | DPDT | | | HA3K-3C2C | HA3K-3C2VC | | | |
| | | Silver | DPDT | | | HA3K-3C6C | — | | | |
| | D  | Gold | DPDT | | | HA3K-3C2D | HA3K-3C2VD | | | |
| | | Silver | DPDT | | | HA3K-3C6D | — | | | |
| | E  | Gold | DPDT | | | HA3K-3C2E | HA3K-3C2VE | | | |
| | | Silver | DPDT | | | HA3K-3C6E | — | | | |
| | G  | Gold | DPDT | | | HA3K-3C2G | HA3K-3C2VG | | | |
| | | Silver | DPDT | | | HA3K-3C6G | — | | | |
| | H  | Gold | DPDT | HA3K-3C2H | HA3K-3C2VH | | | | | |
| | | Silver | DPDT | HA3K-3C6H | — | | | | | |
| | Spring return from right | B  | Gold | DPDT | HA3K-31C2B | HA3K-31C2VB | | | | |
| | | | Silver | DPDT | HA3K-31C6B | — | | | | |
| | | | D  | Gold | DPDT | HA3K-31C2D | HA3K-31C2VD | | | |
| | | | | Silver | DPDT | HA3K-31C6D | — | | | |
| | | | G  | Gold | DPDT | HA3K-31C2G | HA3K-31C2VG | | | |
| | | | | Silver | DPDT | HA3K-31C6G | — | | | |
| | Spring return from left | C  | Gold | DPDT | HA3K-32C2C | HA3K-32C2VC | | | | |
| | | | Silver | DPDT | HA3K-32C6C | — | | | | |
| | | | D  | Gold | DPDT | HA3K-32C2D | HA3K-32C2VD | | | |
| | | | | Silver | DPDT | HA3K-32C6D | — | | | |
| | | | H  | Gold | DPDT | HA3K-32C2H | HA3K-32C2VH | | | |
| | | | | Silver | DPDT | HA3K-32C6H | — | | | |
| Spring return two-way | D  | Gold | DPDT | HA3K-33C2D | HA3K-33C2VD | | | | | |
| | | Silver | DPDT | HA3K-33C6D | — | | | | | |

- Two keys are supplied.
- The front of key cylinder is made with black plastic.
- See page 14 for dimensions.
- Besides the standard key (key number 231), three other key numbers are available (2/3/5). To specify, add the key number in the part number as: HA3K-3C2A-2

Contact Operation

| Operator Position & Contact Operation (Top View) | | | | | |
|--|---|---------|---|--|--|
| Positions | | Contact | ↙ Left | ↑ Center | ↘ Right |
| 90° 2-position |  Maintained  Spring return from right | SPDT |  | — |  |
| | | DPDT | Left Contact  Right Contact  | — | Left Contact  Right Contact  |
| 45° 3-position |  Maintained  Spring return from right  Spring return from left  Spring return two-way | DPDT | Left Contact  Right Contact  | Left Contact  Right Contact  | Left Contact  Right Contact  |

Dimensions

All dimensions in mm.

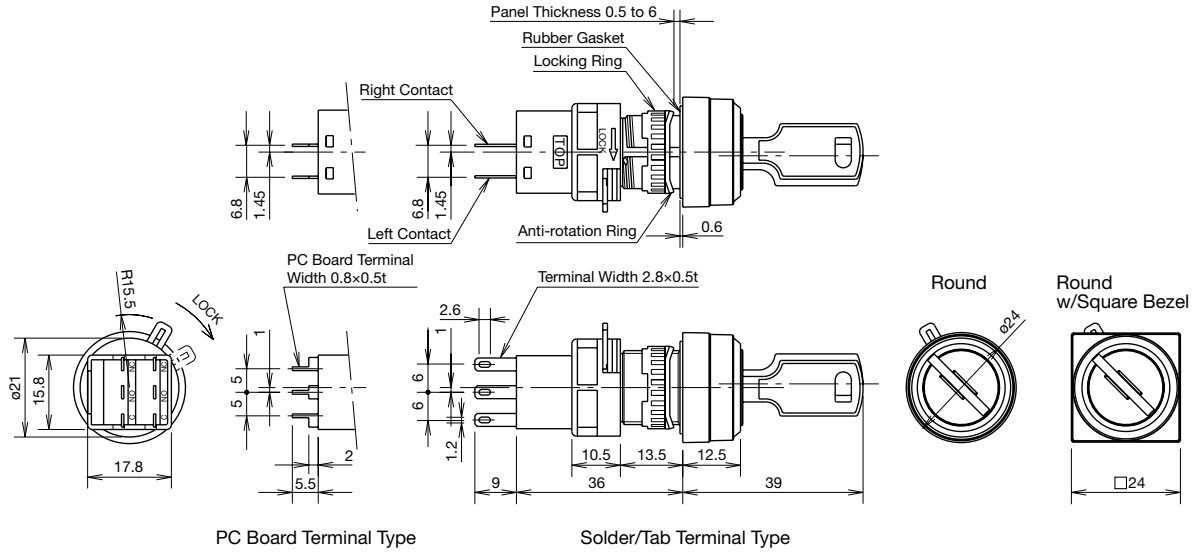

Mounting Hole Layout
Mounting Centers

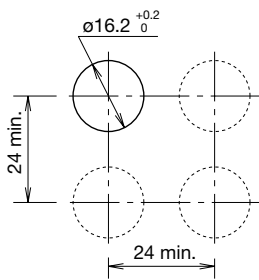

Note: Determine mounting centers to ensure easy operation.

PC Board Drilling Layout
(Bottom View)

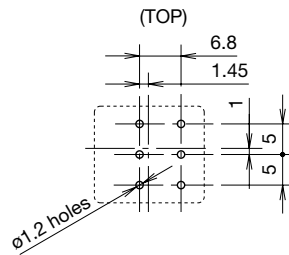



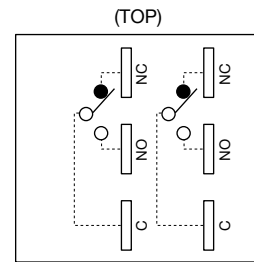

• See Single Board Mounting on page 24 for details about PC boards.

Terminal Arrangement
(Bottom View)



• SPDT has C, NO, and NC on the right only.









HA1F Illuminated Selector Switches

| Shape | Operator Position | | Contact Material | Operating Voltage | Contact | Part No. | Color Code ② |
|--|--|---|------------------|-------------------|-------------|---------------------|---|
| | | | | | | Solder/Tab Terminal | |
| Round HA1F  | 90° 2-position | Maintained  | Gold | 5V DC ±5% | SPDT | HA1F-2C11② | Specify a lens color code in place of ② in the Part No. A: amber G: green PW: pure white R: red S: blue Y: yellow |
| | | | | 12V AC/DC ±10% | DPDT | HA1F-2C21② | |
| | | | | 24V AC/DC ±10% | SPDT | HA1F-2C13② | |
| | | | | DPDT | HA1F-2C23② | | |
| | | | | SPDT | HA1F-2C14② | | |
| | | | | DPDT | HA1F-2C24② | | |
| | | | Silver | 5V DC ±5% | SPDT | HA1F-2C51② | |
| | | 12V AC/DC ±10% | | DPDT | HA1F-2C61② | | |
| | | 24V AC/DC ±10% | | SPDT | HA1F-2C53② | | |
| | | | | DPDT | HA1F-2C63② | | |
| | | | | SPDT | HA1F-2C54② | | |
| | | | | DPDT | HA1F-2C64② | | |
| | | Spring return from right  | Gold | 5V DC ±5% | SPDT | HA1F-21C11② | |
| | 12V AC/DC ±10% | | | DPDT | HA1F-21C21② | | |
| | 24V AC/DC ±10% | | | SPDT | HA1F-21C13② | | |
| | | | DPDT | HA1F-21C23② | | | |
| | | | SPDT | HA1F-21C14② | | | |
| | | | DPDT | HA1F-21C24② | | | |
| | | Silver | 5V DC ±5% | SPDT | HA1F-21C51② | | |
| | 12V AC/DC ±10% | | DPDT | HA1F-21C61② | | | |
| | 24V AC/DC ±10% | | SPDT | HA1F-21C53② | | | |
| | | | DPDT | HA1F-21C63② | | | |
| | | | SPDT | HA1F-21C54② | | | |
| | | | DPDT | HA1F-21C64② | | | |
| 45° 3-position | Maintained  | Gold | 5V DC ±5% | DPDT | HA1F-3C21② | | |
| | | | 12V AC/DC ±10% | DPDT | HA1F-3C23② | | |
| | | | 24V AC/DC ±10% | DPDT | HA1F-3C24② | | |
| | | | Silver | 5V DC ±5% | DPDT | HA1F-3C61② | |
| | | 12V AC/DC ±10% | | DPDT | HA1F-3C63② | | |
| | | 24V AC/DC ±10% | | DPDT | HA1F-3C64② | | |
| | Spring return two-way  | Gold | 5V DC ±5% | DPDT | HA1F-33C21② | | |
| | | | 12V AC/DC ±10% | DPDT | HA1F-33C23② | | |
| | | | 24V AC/DC ±10% | DPDT | HA1F-33C24② | | |
| | | | Silver | 5V DC ±5% | DPDT | HA1F-33C61② | |
| | | 12V AC/DC ±10% | | DPDT | HA1F-33C63② | | |
| | | 24V AC/DC ±10% | | DPDT | HA1F-33C64② | | |



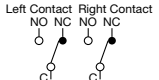
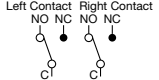

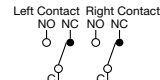
• See page 17 for dimensions.

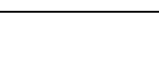
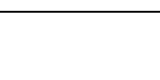
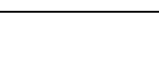
• One LED lamp is installed in illuminated selector switch.

Contact Operation

| Operator Position & Contact Operation (Top View) | | | | | |
|--|---|---------|--|---|---|
| Positions | | Contact | ↙ Left | ↑ Center | ↘ Right |
| 90° 2-position | Maintained  | SPDT |  | — |  |
| | Spring return from right  | DPDT |  | — |  |
| 45° 3-position | Maintained  | DPDT |  |  |  |
| | Spring return two-way  | |  |  |  |









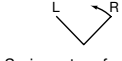
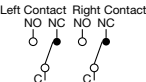
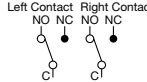

HA3F Illuminated Selector Switches

| Shape | Operator Position | Contact Material | Operating Voltage | Contact | Part No. | | Color Code ② |
|--|---|---|-------------------|----------------|---------------------|-------------|---|
| | | | | | Solder/Tab Terminal | | |
| Round w/Square Bezel HA3F  | 90° 2-position | Maintained  | Gold | SPDT | HA3F-2C11② | | Specify a lens color code in place of ② in the Part No. A: amber G: green PW: pure white R: red S: blue Y: yellow |
| | | | | | DPDT | HA3F-2C21② | |
| | | | | 12V AC/DC ±10% | | SPDT | |
| | | | DPDT | | HA3F-2C23② | | |
| | | | | 24V AC/DC ±10% | SPDT | HA3F-2C14② | |
| | | | DPDT | | | HA3F-2C24② | |
| | | Silver | | 5V DC ±5% | SPDT | HA3F-2C51② | |
| | | | DPDT | | | HA3F-2C61② | |
| | | | | 12V AC/DC ±10% | SPDT | HA3F-2C53② | |
| | | | DPDT | | | HA3F-2C63② | |
| | | | | 24V AC/DC ±10% | SPDT | HA3F-2C54② | |
| | | | DPDT | | | HA3F-2C64② | |
| | Spring return from right  | Gold | | 5V DC ±5% | SPDT | HA3F-21C11② | |
| | | | DPDT | | | HA3F-21C21② | |
| | | | | 12V AC/DC ±10% | SPDT | HA3F-21C13② | |
| | | | DPDT | | | HA3F-21C23② | |
| | | | | 24V AC/DC ±10% | SPDT | HA3F-21C14② | |
| | | | DPDT | | | HA3F-21C24② | |
| | | Silver | | 5V DC ±5% | SPDT | HA3F-21C51② | |
| | | | DPDT | | | HA3F-21C61② | |
| | | | | 12V AC/DC ±10% | SPDT | HA3F-21C53② | |
| | | | DPDT | | | HA3F-21C63② | |
| | | | | 24V AC/DC ±10% | SPDT | HA3F-21C54② | |
| | | | DPDT | | | HA3F-21C64② | |
| 45° 3-position | Maintained  | Gold | | 5V DC ±5% | DPDT | HA3F-3C21② | |
| | | | 12V AC/DC ±10% | | | DPDT | HA3F-3C23② |
| | | | | 24V AC/DC ±10% | DPDT | | HA3F-3C24② |
| | | Silver | 5V DC ±5% | | | DPDT | HA3F-3C61② |
| | | | | 12V AC/DC ±10% | DPDT | | HA3F-3C63② |
| | | | 24V AC/DC ±10% | | | DPDT | HA3F-3C64② |
| | Spring return two-way  | Gold | | 5V DC ±5% | DPDT | | HA3F-33C21② |
| | | | 12V AC/DC ±10% | | | DPDT | HA3F-33C23② |
| | | | | 24V AC/DC ±10% | DPDT | | HA3F-33C24② |
| | | Silver | 5V DC ±5% | | | DPDT | HA3F-33C61② |
| | | | | 12V AC/DC ±10% | DPDT | | HA3F-33C63② |
| | | | 24V AC/DC ±10% | | | DPDT | HA3F-33C64② |

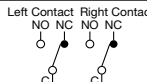
• See page 17 for dimensions.

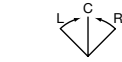
• One LED lamp is installed in illuminated selector switch.

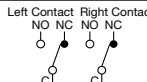
Contact Operation

| Operator Position & Contact Operation (Top View) | | | | | |
|--|---|---------|--|---|---|
| Positions | | Contact | ↖ Left | ↑ Center | ↗ Right |
| 90° 2-position | Maintained  | SPDT |  | — |  |
| | Spring return from right  | DPDT |  | — |  |
| 45° 3-position | Maintained  | DPDT |  |  |  |
| | Spring return two-way  | |  |  |  |

Dimensions

All dimensions in mm.

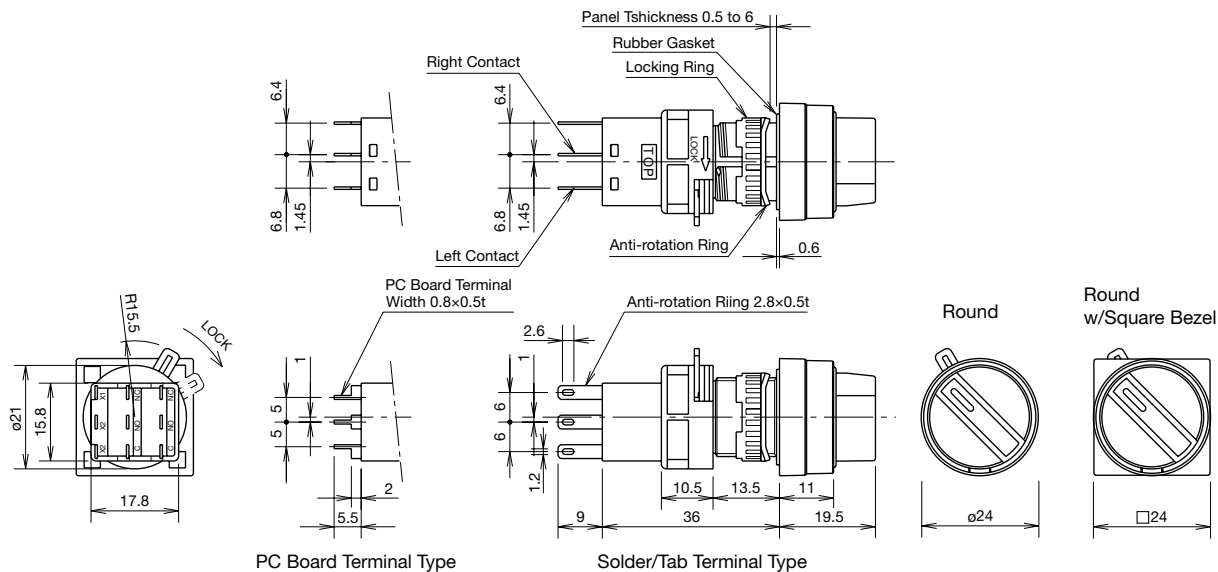

Mounting Hole Layout
Mounting Centers

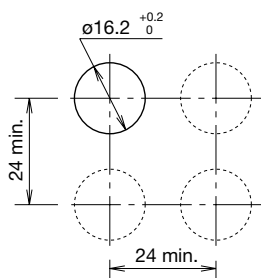

Note: Determine mounting centers to ensure easy operation.

PC Board Drilling Layout
(Bottom View)

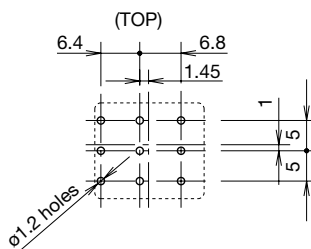

• See Single Board Mounting on page 24 for details about PC boards.

Terminal Arrangement
(Bottom View)

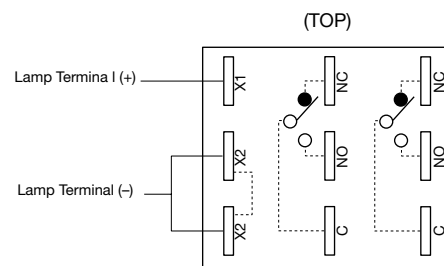

• SPDT has C, NO, and NC on the right only.
• X2 and X2 are wired internally.

HA1R Selector Pushbuttons

| Shape | Operator Position | Contact Operation | | | | | | Contact Material | Contact | Part No. Terminal Style | Color Code ① | | |
|---|--------------------|-------------------|---------------------|---------------------|---------------------|---------------------|--------------------|---------------------|---------------------|-------------------------|-------------------------------|--|-------------------------------|
| | | L | | C | | R | | | | | | | |
| | | Normal | Push | Normal | Push | Normal | Push | | | | | | |
| Round HA1R  | 90° 2-position | Maintained | Left Contact NO NC | Right Contact NO NC | — | — | Left Contact NO NC | Right Contact NO NC | Gold | DPDT | Solder Tab Terminal HA1R-2C2① | B: black G: green R: red S: blue Y: yellow | |
| | | | Left Contact NO NC | Right Contact NO NC | — | — | Left Contact NO NC | Right Contact NO NC | | | PC Board Terminal HA1R-2C2V① | | |
| | | | Left Contact NO NC | Right Contact NO NC | Left Contact NO NC | Right Contact NO NC | Blocked | Blocked | Left Contact NO NC | Right Contact NO NC | Silver | | DPDT |
| | Left Contact NO NC | | Right Contact NO NC | Left Contact NO NC | Right Contact NO NC | Blocked | Blocked | Left Contact NO NC | Right Contact NO NC | Gold | DPDT | | Solder Tab Terminal HA1R-3C2① |
| | Left Contact NO NC | | Right Contact NO NC | Left Contact NO NC | Right Contact NO NC | Blocked | Blocked | Left Contact NO NC | Right Contact NO NC | Silver | DPDT | | PC Board Terminal HA1R-3C2V① |
| | Left Contact NO NC | | Right Contact NO NC | Left Contact NO NC | Right Contact NO NC | Blocked | Blocked | Left Contact NO NC | Right Contact NO NC | | | | Solder Tab Terminal HA1R-3C6① |

• Specify a button color code in place of ① in the Part No.

Dimensions

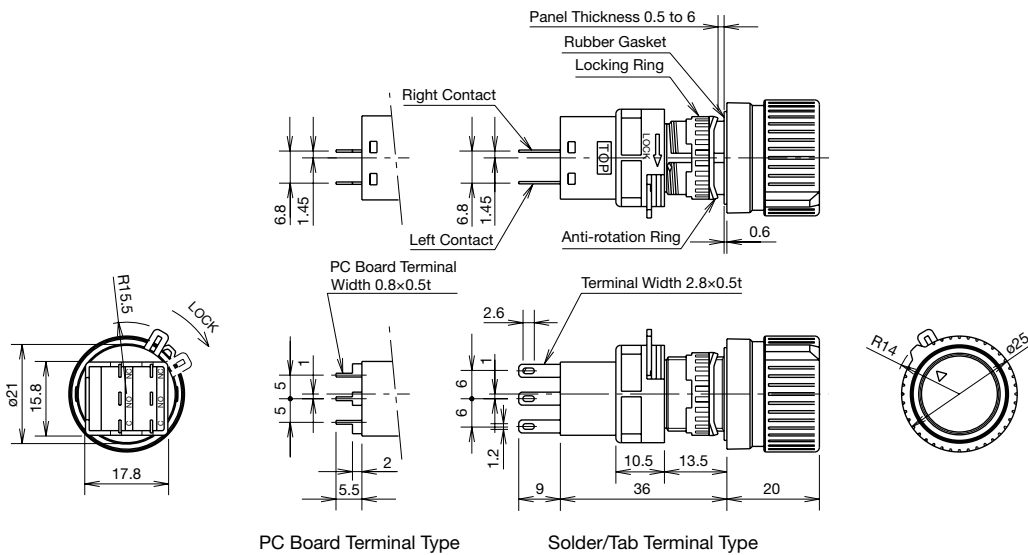

Mounting Hole Layout
 Mounting Centers

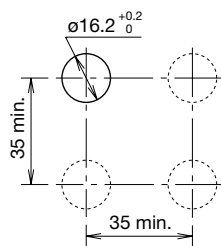

Note: Determine mounting centers to ensure easy operation.

PC Board Panel Cut-out
 (Bottom View)

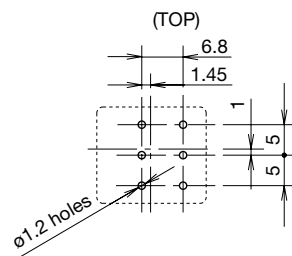





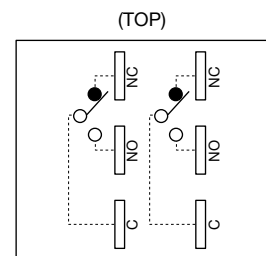



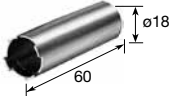

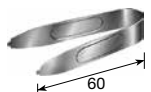
• See Single Board Mounting on page 24 for details about PC boards.



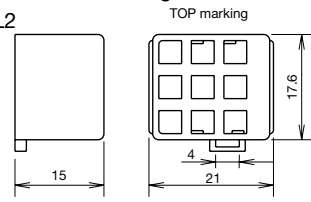
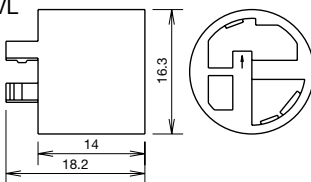

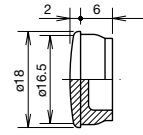
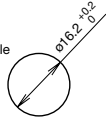

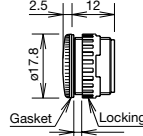
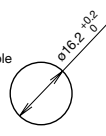









Terminal Arrangement
 (Bottom View)



Accessories

| Shape | Material | Part No. | Ordering Part No. | Package Quantity | Remarks |
|---|--|---------------------|---------------------|------------------|--|
|  | Metal (nickel-plated brass) | MT-001 | MT-001 | 1 | <ul style="list-style-type: none"> Used to tighten the locking ring when installing H6 into a panel. Tighten the locking ring to a torque of 0.88 N·m. |
|  | Rubber (nitril) | OR-44 | OR-44 | 1 | <ul style="list-style-type: none"> Used to install and remove LED lamps. |
|  | Stainless Steel | MT-101 | MT-101 | 1 | <ul style="list-style-type: none"> Used to remove the lens or buttons. |
|  | Guard (Polyarylate) Base (polyacetal) | HA9Z-K1 HA9Z-KW1 | HA9Z-K1 HA9Z-KW1 | 1 1 | <ul style="list-style-type: none"> Degree of protection: IP65 Used to protect flush pushbuttons from inadvertent operation.  |
|  | Nylon (white) | H6-VL2 | H6-VL2PN10 | 10 | <ul style="list-style-type: none"> Terminal cover is not attached and must be ordered separately. When wiring the terminals, insert the lead wires into the terminal cover holes before soldering.   |
|  | Exclusive for Unibody Pilot Light | H6-PVL | H6-PVLPN10 | 10 | |
|  | Nitril Rubber (black) | AL-B6 | AL-B6PN05 | 5 | <ul style="list-style-type: none"> Degree of protection: IP65   |
|  | Plug: Metal (diecast) Locking ring: plastic Gasket: nitril | AL-BM6 | AL-BM6 | 1 | <ul style="list-style-type: none"> Degree of protection: IP65 Tightening torque: 0.1 to 0.29 N·m   <p>Gasket Locking Ring Panel Thickness 0.5 to 6</p> |

Maintenance Parts

| Shape | Specification | Part No. | Ordering Part No. | Package Quantity | Remarks | | |
|--|---|------------------------------------|-------------------|------------------|---------|--|--------------|
| Lens  ①  ②  ③ | Round, Round w/Square Bezel | Polyarylate | HA9Z-L11② | HA9Z-L11②PN05 | 5 | Specify a color code in place of ② in the Part No. A (amber), C (clear), G (green), R (red), S (blue), Y (yellow) Note: Use C (clear) lens for PW (pure white) illumination. | |
| | Square | | HA9Z-L21② | HA9Z-L21②PN05 | | | |
| | ø30mm Lens | | HA9Z-L13② | HA9Z-L13②PN05 | | | |
| Button  ①  ②  ③  ④  ⑤  ⑥ | Round Flush, Round w/Square Bezel | Polyacetal | HA9Z-B11① | HA9Z-B11①PN05 | 2 | Specify a color code in place of ① in the Part No. B (black), G (green), R (red), S (blue), W (white), Y (yellow) | |
| | Square Flush | | HA9Z-B21① | HA9Z-B21①PN05 | | | |
| | Round Extended, Round Extended w/Square Bezel | | HA9Z-B12① | HA9Z-B12①PN05 | | | |
| | Square Extended | | HA9Z-B22① | HA9Z-B22①PN05 | | | |
| | ø30mm Button | | HA9Z-B13① | HA9Z-B13①PN05 | | | |
| | Selector Pushbutton | | HA1A-R1① | HA1A-R1①PN02 | | | |
| Marking Plate  | Round, Round w/Square Bezel | Acrylic | White | HA9Z-P1W | 5 | <ul style="list-style-type: none"> • HA9Z-P1W (engraving area: ø16.4 mm, engraving depth: 0.5 mm max.) • HA9Z-P2W (engraving area: □16.4 mm, engraving depth: 0.5 mm max.) | |
| | Square | | Black | HA9Z-P1B | | | HA9Z-P1BPN05 |
| | | | White | HA9Z-P2W | | | HA9Z-P2WPN05 |
| | | | Black | HA9Z-P2B | | | HA9Z-P2BPN05 |
| Locking Ring  | For all types | Polyacetal | HA9Z-LN | HA9Z-LNPN10 | 10 | | |
| Anti-rotation Ring  | For all types except for HA1E | Stainless Steel | HA9Z-LP | HA9Z-LPPN10 | | | |
| Lever Lock  | For all types except for collective mounting and HA1E | Polyacetal | HA9Z-LS | HA9Z-LSPN10 | 5 | <ul style="list-style-type: none"> • Lever lock is not attached and must be ordered separately. • Yellow | |
| Selector Color Insert  | For selector switch | Polyacetal | HA9Z-HC1① | HA9Z-HC1①PN05 | | Specify a color code in place of ① in the Part No. G (green), R (red), S (blue), W (white), Y (yellow) | |
| Spare Key  | For key selector switches | Nickel-plated Brass | KG9Z-SK-231 | KG9Z-SK-231PN02 | 2 | <ul style="list-style-type: none"> • Thickness: 2.0mm • Besides the standard key number (231), three other numbers (2, 3, 5) are available. Ordering part number: KG9Z-SK-2PN02 KG9Z-SK-3PN02 KG9Z-SK-5PN02 | |
| Illuminated Selector Knob  | For illuminated selector switch | Polyarylate (w/water-proof gasket) | HA1A-F② | HA1A-F② | 1 | Specify a color code in place of ② in the Part No. A (amber), G (green), R (red), S (blue), W (white), Y (yellow) Note: Use W (white) knob for PW (pure white) illumination. | |

LED Lamps

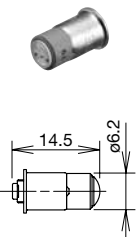
| Dimension | Rated Voltage | Current Draw | | Part No. | Ordering Part No. | ② Illumination Color Code | Package Quantity | Base |
|---|---------------|---------------------------|------------------------------------|----------|-------------------|--|------------------|------------|
| | | DC | AC | | | | | |
|  | 5V DC | 8 mA (except S) 7m (S) | — | LFTD-5② | LFTD-5② | Specify a color code in place of ② in the Ordering Part No. A: amber G: green PW: pure white R: red S: blue | 1 | SX6S/8×5.4 |
| | | | | | LFTD-5②PN10 | | 10 | |
| | 6V AC/DC | 7 mA (except S) 6m (S) | 9 mA (A, R, S, W) 10 mA (G, PW) | LFTD-6② | LFTD-6② | | 1 | |
| | | | | | LFTD-6②PN10 | | 10 | |
| | 12V AC/DC | 8 mA (except S) 7m (S) | 9 mA (except S) 8m (S) | LFTD-1② | LFTD-1② | | 1 | |
| | | | | | LFTD-1②PN10 | | 10 | |
| | 24V AC/DC | 8 mA (except S) 7m (S) | 9 mA (except S) 8m (S) | LFTD-2② | LFTD-2② | 1 | | |
| | | | | | LFTD-2②PN10 | 10 | | |
| Use a PW (pure white) LED lamp for yellow illumination. | | | | | | | | |

Transformer

| Transformer | Rated Voltage | Operating Voltage Range | Part No. | Applicable LED Lamp |
|---|---------------|-------------------------|----------|---------------------|
|  | 100/110V AC | 100/110V AC ±10% | TWR512 | LFTD-2② |
| | 200/220V AC | 200/220V AC ±10% | TWR522 | |
| | 400/440V AC | 400/440V AC ±10% | TWR542 | |

- Terminal covers are supplied with separate mounting type transformers.
- Connect only one LFTD LED to separate mounting type transformers.

Dimensions

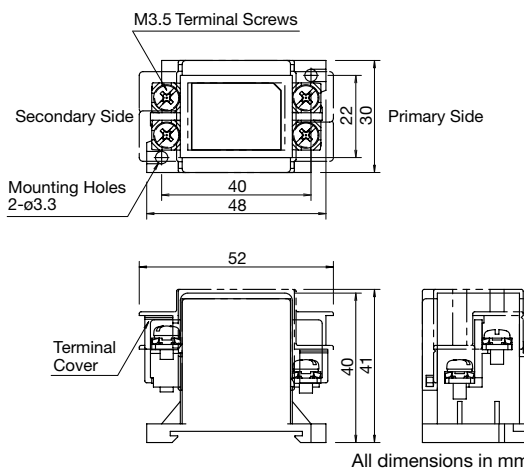

Specifications

| | | |
|------------------------------|--|-------------------------------|
| Rated Voltage | 100/110V AC, 200/220V AC, 400/440V AC (50/60 Hz) | |
| Power Consumption | 2.4VA | |
| Rated Insulation Voltage | 600V | |
| Insulation Resistance | 100 MΩ minimum (500V DC megger) | |
| Dielectric Strength | 2500V AC, 1 minute | |
| Standard Operating Condition | Operating Temperature | -30 to +60°C (no freezing) |
| | Relative Humidity | 35 to 85% (no condensation) |
| Vibration Resistance | Operating Extremes | 5 to 55 Hz, amplitude 0.5 mm |
| Shock Resistance | Damage Limits | 1,000 m/s ² (100G) |
| Terminal Screw | M3.5 | |
| Applicable Wire | 2 mm ² maximum, 2 wires maximum | |

Accessories

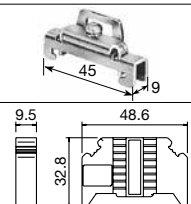
| Description | Appearance | Description | Part No. | Ordering Part No. | Package Quantity |
|-------------|---|----------------------------------|--------------|-------------------|------------------|
| DIN Rail |  | Aluminum Weight: Approx. 200g | BAA1000 | BAA1000PN10 | 10 |
| | | Steel Weight: Approx. 320g | BAP1000 | BAP1000PN10 | |
| End Clip |  | Steel Weight: Approx. 15g | BNL6 | BNL6PN10 | |
| | | Plastic Weight: Approx. 15g | BC9Z-E/NS35N | BC9Z-E/NS35NPN10 | |

Dimensions

All dimensions in mm.

Terminal Cover

For W/removable Contact Block (H6-VL2)

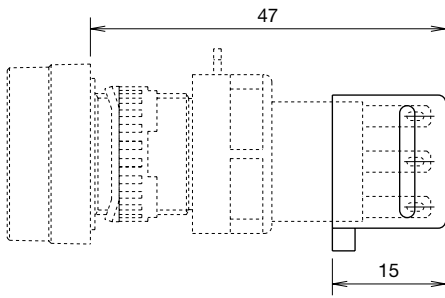

For Unibody (H6-PVL)

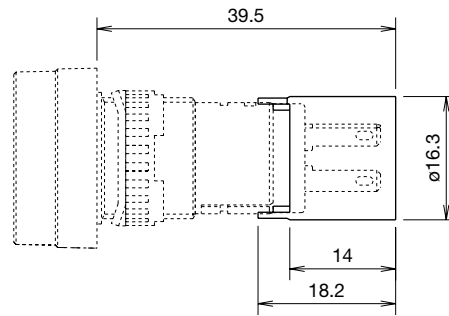

Switch Guard

For Flush Pushbuttons and Illuminated Pushbuttons

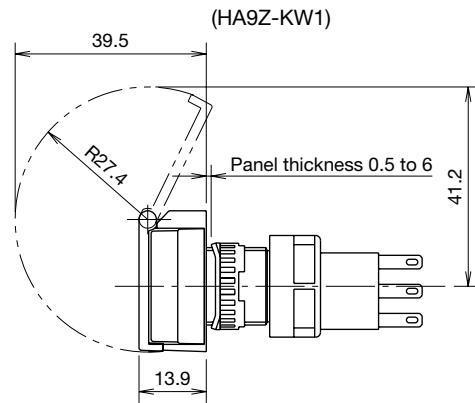
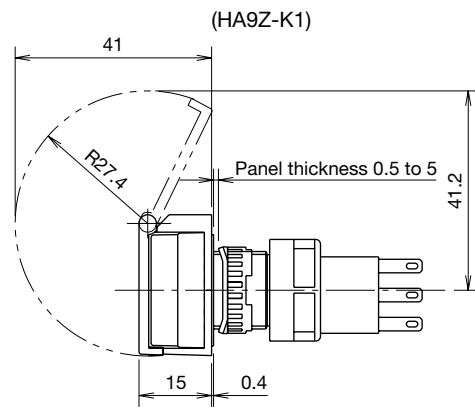
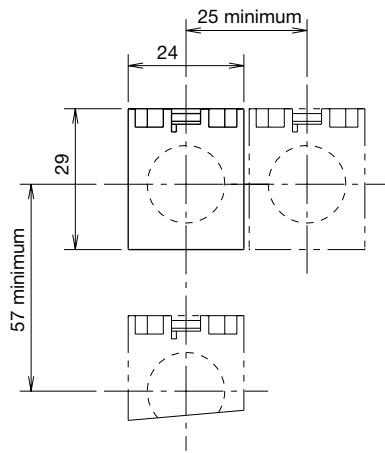

Safety Precautions

- Turn off the power to H6 series before installation, removal, wiring, maintenance, and inspection of the units. Failure to turn power off may cause electrical shocks or fire hazard.
- To avoid burning your hand, use the lamp holder tool when replacing lamps.
- For wiring, use wires of a proper gauge to meet voltage and current requirements. Improper soldering may cause overheating and create a fire hazard.

Instructions

Replacement of Lens and Marking Plate

Removing the Lens

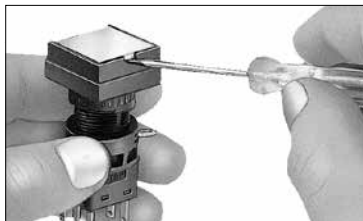

Removing the Marking Plate

Remove the marking plate by pushing the lens from the rear to disengage the latches between the lens and the lens holder, using the screwdriver as shown below.

Note: The translucent filter in the lens holder cannot be removed because this filter is sealed to make the unit waterproof.

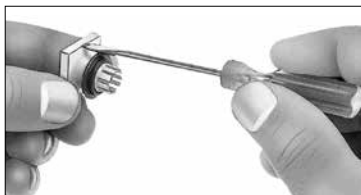

Installing

For round lens types, place the marking plate on the lens holder with the projection engaged and press the lens onto the lens holder to engage the latches. For square lens types, insert the marking plate into the lens, and press the lens onto the holder to engage the latches.

Note: Make sure of correct orientation of the marking plate.

[Round Lens Type]

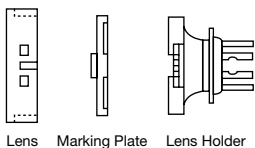

[Square Lens Type]

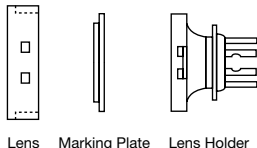

Replacement of Lamps

Lamps can be replaced using the lamp holder tool (OR-44) from the front of the panel, or by removing the contact block from the operator.

Removing the Lamp

1. Slip the lamp holder tool onto the lamp head. Then push slightly, and turn the lamp holder tool counterclockwise.



2. Push the bulb, and remove from the rear of the lamp holder.



Installing the Lamp

1. Insert the lamp into the lamp holder from the rear, and push in completely using the smaller end of the lamp holder tool.

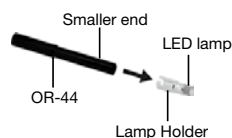

2. Hold the bulb with the lamp holder tool as shown below.

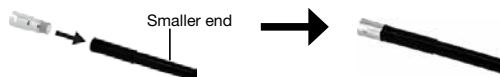

3. Place the insertion guide of the lamp holder and the TOP marking side or the groove in the operator unit in the same direction. Insert the lamp holder into the housing with the lamp holder tool. Then push the lamp lightly and turn it clockwise to install.

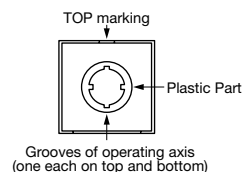

Panel Mounting

Remove the contact block from the operator. Insert the operator into the panel cut-out from the front, then install the contact block to the operator.

Removing the Contact Block

Turn the locking lever on the contact block in the direction opposite to the arrow on the housing. Then the contact block can be removed.

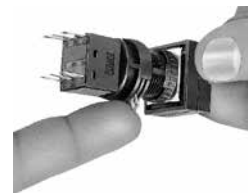

Installing the Contact Block

Insert the contact block with the TOP markings on the contact block and the operator placed in the same direction. Then lock the units, turning the locking lever in the direction of the arrow.

Notes for Mounting

Use the optional Ring Wrench (MT-001) to mount the operator onto a panel. Tightening torque should not exceed 0.88 N·m. Do not use pliers. Do not tighten with excessive force, otherwise the locking ring will be damaged.

Collective Mounting

As the locking lever can be turned easily from the rear of the units using a screwdriver, the contact blocks can be removed even when mounted collectively.

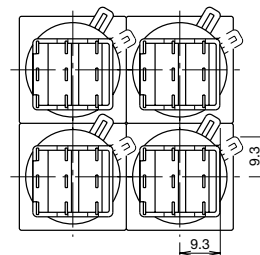

Instructions

Marking Plates and Films

For H6 series illuminated pushbuttons and pilot lights, legends and symbols can be engraved on marking plates, or printed mylar film can be inserted under the lens for labelling purposes.

Marking Plate and Marking Film Size

| Lens | Round Lens (round, round w/square bezel) | Square Lens |
|-------------------------|---|-------------|
| Built-in Marking Plate | <p>• Engraving must be made on the engraving area within 0.5mm deep. • The marking plate is made of white acrylic resin.</p> | |
| Applicable Marking Film | <p>• Two 0.1mm-thick films or one 0.2mm-thick film can be installed in the lens. • Marking film is not included. • Recommended marking film: Polyester film</p> | |

Insertion Order of Marking Plate and Film

[Round Lens Type]

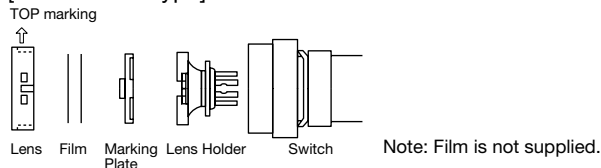

[Square Lens Type]

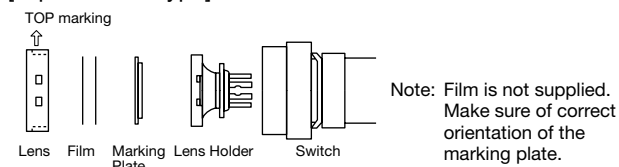

Wiring

- Solder the terminals at 350°C within 3 seconds using a 60W soldering iron. Sn-Ag-Cu type is recommended when using lead-free solder. When soldering, do not touch the H6 with the soldering iron. Also ensure that no tensile force is applied to the terminal. Do not bend the terminal or apply excessive force to the terminal.
- Use non-corrosive liquid flux.

Notes on Terminal Cover

Insert the terminal cover into the contact block with the TOP markings on the contact block and the terminal cover in the same direction.

Note: When wiring, insert the lead wires into the terminal cover holes before soldering.

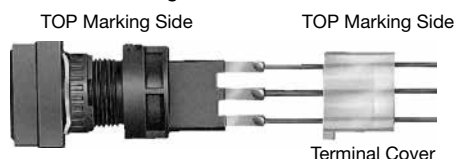

Connection

Positive-lock connector and easy-lock connector are applicable to tab terminals.

Recommended Connectors

| Item | Positive-lock Connector (Tyco Electronics) | | Easy-lock Connector (Nichifu Co., Ltd.) | |
|---------|---|----------------------------|--|----------------------------|
| | Terminal | 0.2 to 0.5 mm ² | 175412-1 | 0.2 to 0.3 mm ² |
| | 0.2 to 1.25 mm ² | 174778-1 | 0.5 to 1.25 mm ² | OSS-62815F3 |
| Housing | 174779-1 | | NET1-28-1P | |

Note: Positive-lock is a registered trademark of Tyco Electronics.

Single Board Mounting

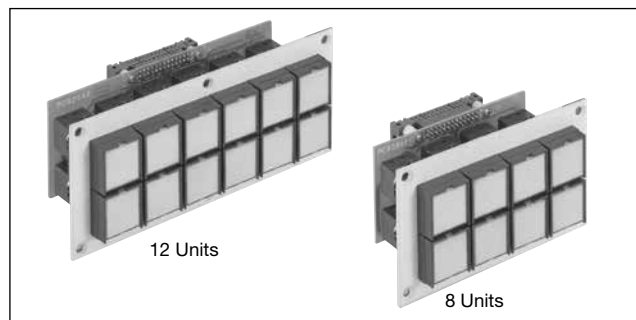

Mounting the PC board terminal type units on a PC board offers the following features.

Features

- Reduced installation labor, easy wiring, space saving, and standardization.
- Since the contact blocks on the PC board can be removed easily using a locking lever, the H6 series is easy to maintain.
- Because the H6 series requires no studs for fastening the unit to a PC board, special preparation of the control panel is not needed.

Notes for Designing PC board and Circuit

- Use 1.6-mm-thick glass epoxy PC board with drilled holes.
- Design a circuit so that the H6 series can operate within the rated voltage and current range. Make sure that inrush current and voltage do not exceed the rating.
- Minimum applicable load is 5V AC/DC, 1 mA on gold contacts. Applicable range is subject to the operating condition and load.
- Since the 2.8-mm-wide terminal touches the PC board as shown on the right, short circuit may occur with pattern lines. Design a circuit carefully to prevent short circuit.

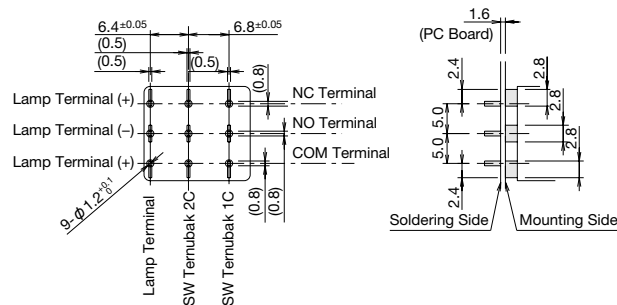

PC Board Drilling Layout

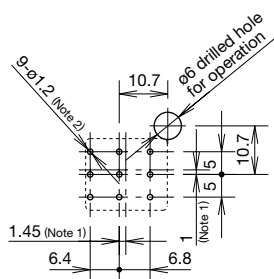

Note 1: When designing, note the alignment of centerlines of the contact blocks and centerlines of the operators.
 Note 2: The diameter of the terminal hole is 1.2 mm.

Installation and Removal of Contact Blocks

Turn the locking lever to install and remove the contact block on the PC board by using a screwdriver from a hole (ø6 mm) of the PC board.

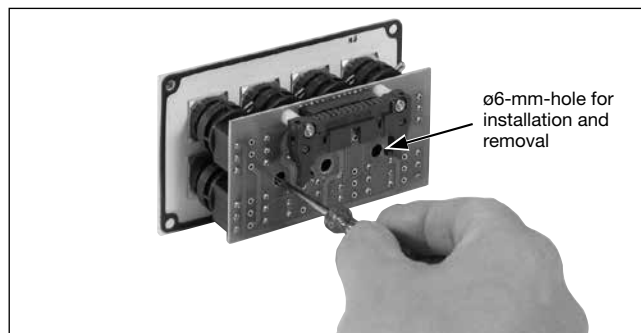

Hole diameter may vary to meet installation requirements. When the locking lever can be turned by using a screwdriver from the upper or right space, the holes are not necessary.

<Example>

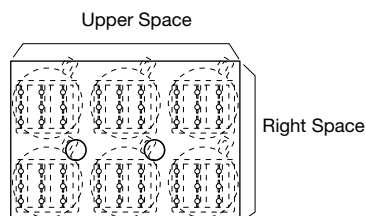

Mounting Holes and Assembly Procedure

• Drill mounting holes in the panel as shown below. When the units are mounted collectively, provide adequate clearance.

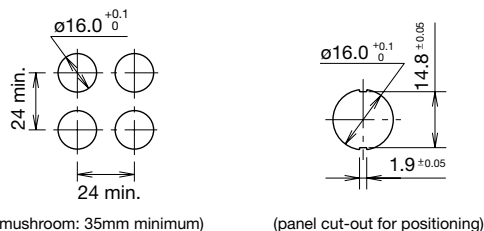

(ø30 mushroom: 35mm minimum)

(panel cut-out for positioning)

• Assembly Procedure

1. Install the operator to the operation panel.
2. Insert the contact block to the operator from the rear.
3. Turn the lock lever to lock the contact block.
4. Insert the PC board to terminals and solder.

Note 1: Make sure that each terminal is inserted into the PC board correctly.

Note 2: Do not apply tensile force to the connector cable for extended period of time.

Note 3: Do not expose the contact block to water.

Note 4: Ensure to lock contact blocks when the contact blocks are installed on the operators.

Switchguard for Single Board Mounting



Part No. HA9Z-KW1

See page 22 for dimensions.

Note: H6 series with or without switchguard can be used on a single board, as the depth behind the panel to the PC board is the same.

Ordering Terms and Conditions

Thank you for using IDEC Products.

By purchasing products listed in our catalogs, datasheets, and the like (hereinafter referred to as "Catalogs") you agree to be bound by these terms and conditions. Please read and agree to the terms and conditions before placing your order.

1. Notes on contents of Catalogs

- (1) Rated values, performance values, and specification values of IDEC products listed in this Catalog are values acquired under respective conditions in independent testing, and do not guarantee values gained in combined conditions.
Also, durability varies depending on the usage environment and usage conditions.
- (2) Reference data and reference values listed in Catalogs are for reference purposes only, and do not guarantee that the product will always operate appropriately in that range.
- (3) The specifications / appearance and accessories of IDEC products listed in Catalogs are subject to change or termination of sales without notice, for improvement or other reasons.
- (4) The content of Catalogs is subject to change without notice.

2. Note on applications

- (1) If using IDEC products in combination with other products, confirm the applicable laws / regulations and standards.
Also, confirm that IDEC products are compatible with your systems, machines, devices, and the like by using under the actual conditions. IDEC shall bear no liability whatsoever regarding the compatibility with IDEC products.
- (2) The usage examples and application examples listed in Catalogs are for reference purposes only. Therefore, when introducing a product, confirm the performance and safety of the instruments, devices, and the like before use. Furthermore, regarding these examples, IDEC does not grant license to use IDEC products to you, and IDEC offers no warranties regarding the ownership of intellectual property rights or non-infringement upon the intellectual property rights of third parties.
- (3) When using IDEC products, be cautious when implementing the following.
 - i. Use of IDEC products with sufficient allowance for rating and performance
 - ii. Safety design, including redundant design and malfunction prevention design that prevents other danger and damage even in the event that an IDEC product fails
 - iii. Wiring and installation that ensures the IDEC product used in your system, machine, device, or the like can perform and function according to its specifications
- (4) Continuing to use an IDEC product even after the performance has deteriorated can result in abnormal heat, smoke, fires, and the like due to insulation deterioration or the like. Perform periodic maintenance for IDEC products and the systems, machines, devices, and the like in which they are used.
- (5) IDEC products are developed and manufactured as general-purpose products for general industrial products. They are not intended for use in the following applications, and in the event that you use an IDEC product for these applications, unless otherwise agreed upon between you and IDEC, IDEC shall provide no guarantees whatsoever regarding IDEC products.
 - i. Use in applications that require a high degree of safety, including nuclear power control equipment, transportation equipment (railroads / airplanes / ships / vehicles / vehicle instruments, etc.), equipment for use in outer space, elevating equipment, medical instruments, safety devices, or any other equipment, instruments, or the like that could endanger life or human health
 - ii. Use in applications that require a high degree of reliability, such as provision systems for gas / waterworks / electricity, etc., systems that operate continuously for 24 hours, and settlement systems
 - iii. Use in applications where the product may be handled or used deviating from the specifications or conditions / environment listed in the Catalogs, such as equipment used outdoors or applications in environments subject to chemical pollution or electromagnetic interference
If you would like to use IDEC products in the above applications, be sure to consult with an IDEC sales representative.

3. Inspections

We ask that you implement inspections for IDEC products you purchase without delay, as well as thoroughly keep in mind management/maintenance regarding handling of the product before and during the inspection.

4. Warranty

- (1) Warranty period
The warranty period for IDEC products shall be one (1) year after purchase or delivery to the specified location. However, this shall not apply in cases where there is a different specification in the Catalogs or there is another agreement in place between you and IDEC.
- (2) Warranty scope
Should a failure occur in an IDEC product during the above warranty period for reasons attributable to IDEC, then IDEC shall replace or repair that product, free of charge, at the purchase location / delivery location of the product, or an IDEC service base. However, failures caused by the following reasons shall be deemed outside the scope of this warranty.
 - i. The product was handled or used deviating from the conditions / environment listed in the Catalogs
 - ii. The failure was caused by reasons other than an IDEC product
 - iii. Modification or repair was performed by a party other than IDEC
 - iv. The failure was caused by a software program of a party other than IDEC
 - v. The product was used outside of its original purpose
 - vi. Replacement of maintenance parts, installation of accessories, or the like was not performed properly in accordance with the user's manual and Catalogs
 - vii. The failure could not have been predicted with the scientific and technical standards at the time when the product was shipped from IDEC
 - viii. The failure was due to other causes not attributable to IDEC (including cases of force majeure such as natural disasters and other disasters)Furthermore, the warranty described here refers to a warranty on the IDEC product as a unit, and damages induced by the failure of an IDEC product are excluded from this warranty.

5. Limitation of liability

The warranty listed in this Agreement is the full and complete warranty for IDEC products, and IDEC shall bear no liability whatsoever regarding special damages, indirect damages, incidental damages, or passive damages that occurred due to an IDEC product.

6. Service scope

The prices of IDEC products do not include the cost of services, such as dispatching technicians. Therefore, separate fees are required in the following cases.

- (1) Instructions for installation / adjustment and accompaniment at test operation (including creating application software and testing operation, etc.)
- (2) Maintenance inspections, adjustments, and repairs
- (3) Technical instructions and technical training
- (4) Product tests or inspections specified by you

The above content assumes transactions and usage within your region. Please consult with an IDEC sales representative regarding transactions and usage outside of your region. Also, IDEC provides no guarantees whatsoever regarding IDEC products sold outside your region.

IDEC CORPORATION

Head Office

6-64, Nishi-Miyahara-2-Chome, Yodogawa-ku, Osaka 532-0004, Japan

| | | | |
|------------------|-------------------------------------|------------------------|----------------------|
| USA | IDEC Corporation | Tel: +1-408-747-0550 | opencontact@idec.com |
| Germany | APEM GmbH | Tel: +49-40-25 30 54-0 | service@eu.idec.com |
| Singapore | IDEC Izumi Asia Pte. Ltd. | Tel: +65-6746-1155 | info@sg.idec.com |
| Thailand | IDEC Asia (Thailand) Co., Ltd | Tel: +66-2-392-9765 | sales@th.idec.com |
| India | IDEC Controls India Private Limited | Tel: +91-80679-35328 | info_india@idec.com |
| Taiwan | IDEC Taiwan Corporation | Tel: +886-2-2577-6938 | service@tw.idec.com |

| | | | |
|------------------|-----------------------------|-----------------------|-----------------------|
| Hong Kong | IDEC Izumi (H.K.) Co., Ltd. | Tel: +852-2803-8989 | info@hk.idec.com |
| China | IDEC (Shanghai) Corporation | Tel: +86-21-6135-1515 | idec@cn.idec.com |
| | Beijing Branch | Tel: +86-10-6581-6131 | idec@cn.idec.com |
| | Guangzhou Branch | Tel: +86-20-8362-2394 | idec@cn.idec.com |
| Japan | IDEC Corporation | Tel: +81-6-6398-2527 | jp_marketing@idec.com |

 www.idec.com

Specifications and other descriptions in this brochure are subject to change without notice.

