

1. Product Introduction

Features

Features of Banflescram

■ Vibration-free stable transmission

The belt bonds two or three ridges and therefore is mostly vibration-free. Hence, it allows stable transmission without the belt flipping over or detachment from the pulleys.

■ Most suitable for vertical shaft drive operation

The bonding of the belt prevents contact between belts and detachment from the pulleys. Therefore, even in the case of a vertical shaft drive, there is no need to use special pulleys (such as deep-grooved pulleys).

Features common to Banflescram and Banflex

■ High-speed and smooth power transmission

The high accuracy of the belt cross-section and effective length and no variation of belt sink on the pulleys allow high-speed smooth power transmission close to flat belts. Although the previous V-belts can be used up to 30 to 40 m/s, Banflescram can be designed to be used with a speed up to 60 m/s.

■ Lightweight and compact design

It can be used with small pulley diameters, allows for a high speed ratio, and allows the power transmission system to be light and compact. For example, a device that had used two-stage deceleration with V-belts can be changed to one-stage deceleration.

Structure

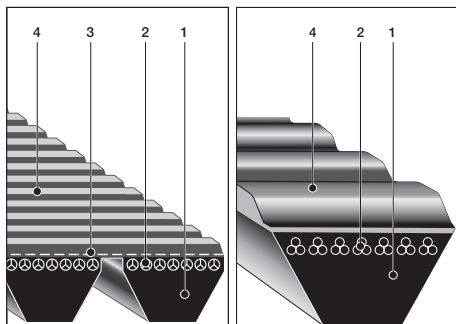

1. Compression rubber

- Polyurethane rubber with excellent abrasion resistance and large friction factor and allowable compression stress
- 60° belt angle that gives uniform load distribution

2. Cord

Polyester cord with a large tensile strength, little flex fatigue, and little permanent elongation

3. Reinforcing canvas

Polyamide fiber that increases the widthwise rigidity and ensures stable running

4. Back face rib

Unique ribs that reduce bending stress

Note)

- When you use multiple Banflex belts, be sure to use the Scrum type.
- To provide the dynamic performance of the belt, a "lubricant" is compounded in the belt. This compounding ingredient may become deposited in white on the belt surface due to changes in ambient temperature etc. or may become slightly wet due to a liquid. This will be absorbed into the belt with time and is no abnormality.

Matched set

When using a combination of multiple belts, please specify a matched set. We deliver a set of belts of lengths within the allowable range shown in the following table.

■ Allowable range of effective lengths for use of multiple belts (matching limit)

Nominal outside length	Allowable range of length (mm)
180~500	0.25
515~1000	0.50
1030~1500	0.75
1550~2300	1.00

Belt Combinations

Banflescram has two or three ridges as the standard. For four or more ridges, please use a combination of belts with two and three belts as shown in the following table. (The recommended maximum number of ridges is 12.)

■ Belt combination

No. of ridges	Combination	No. of ridges	Combination
2	2	7	2+3+2
3	3	8	3+2+3
4	2+2	9	3+3+3
5	2+3	10	2+3+3+2
6	3+3	12	3+3+3+3

Standard length of Banflescram

■ Belt indication method

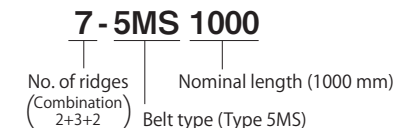

■ Cross-sectional profile of Banflescram belt

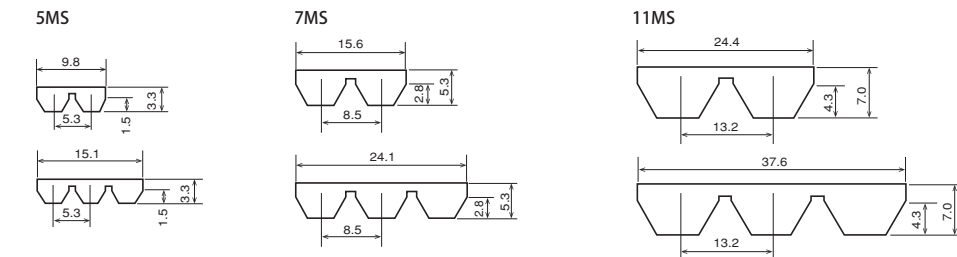

■ Standard effective lengths (Banflescram)

5MS				7MS				11MS			
Nominal length	Pitch length	Nominal length	Pitch length	Nominal length	Pitch length	Nominal length	Pitch length	Nominal length	Pitch length	Nominal length	Pitch length
280	277	670	667	500	494	1084	1084	710	701	1280	1271
290	287	690	687	515	509	1120	1114	730	721	1320	1311
300	297	710	707	530	524	1150	1144	750	741	1360	1351
307	304	730	727	545	539	1180	1174	775	766	1400	1391
315	312	750	747	560	554	1220	1214	800	791	1450	1441
325	322	775	772	580	574	1250	1244	825	816	1500	1491
335	332	800	797	600	594	1280	1274	850	841	1550	1541
345	342	805	802	615	609	1320	1314	875	866	1600	1591
355	352	825	822	630	624	1360	1354	900	891	1650	1641
365	362	850	847	650	644	1400	1394	925	916	1700	1691
375	372	875	872	670	664	1450	1444	950	941	1750	1741
387	384	900	897	690	684	1500	1494	975	966	1800	1791
400	397	925	922	710	704	1550	1544	1000	991	1850	1841
412	409	950	947	730	724	1600	1594	1030	1021	1900	1891
425	422	975	972	750	744	1650	1644	1060	1051	1950	1941
437	434	1000	997	775	769	1700	1694	1090	1081	2000	1991
450	447	1030	1027	800	794	1750	1744	1120	1111	2060	2051
462	459	1060	1057	825	819	1800	1794	1150	1141	2120	2111
475	472	1090	1087	850	844	1850	1844	1180	1171	2180	2171
487	484	1120	1117	875	869	1900	1894	1220	1211	2240	2231
500	497	1150	1147	900	894	1950	1944	1250	1241	2300	2291
515	512	1180	1177	925	919	2000	1994				
518	515	1220	1217	950	944	2060	2054				
530	527	1250	1247	975	969	2120	2114				
545	542	1280	1277	1000	994	2180	2174				
560	557	1320	1317	1030	1024	2240	2234				
580	577	1360	1357	1060	1054	2300	2294				
600	597	1400	1397								
615	612	1450	1447								
630	627	1500	1497								
650	647	1850	1847								

■ Belt outside length tolerance

Nominal outside length	Outside length tolerance (mm)
180~ 307	±2.5
315~ 615	±4.0
630~1090	±5.0
1120~1500	±6.5
1550~1900	±7.5
1950~2300	±9.0

(Note) Please note that when you switch from Banflex to Banflescram, the center distance becomes shorter (3 to 5 mm for 5M → 5MS, 5 to 6 mm for 7M → 7MS, 6 to 8 mm for 11M → 11MS).

Banflex standard length

■ Belt indication method

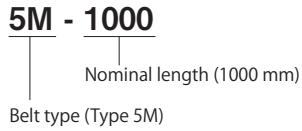

■ Cross-sectional profile of Banflex belt

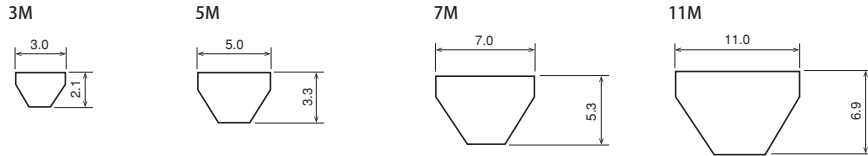

■ Standard effective lengths (Banflex)

(Unit: mm)

Nominal length	3M		5M		7M		11M								
	Pitch length	Nominal length	Pitch length	Nominal length	Pitch length	Nominal length	Pitch length	Nominal length							
180	178	437	435	280	278	670	668	500	496	1220	1216	710	703	1750	1743
185	183	450	448	290	288	690	688	515	511	1250	1246	730	723	1800	1793
190	188	462	460	300	298	710	708	530	526	1280	1276	750	743	1850	1843
195	193	475	473	307	305	730	728	545	541	1320	1316	775	768	1900	1893
200	198	487	485	315	313	750	748	560	556	1360	1356	800	793	1950	1943
206	204	500	498	325	323	775	773	580	576	1400	1396	825	818	2000	1993
212	210	515	513	335	333	800	798	600	596	1450	1446	850	843	2060	2053
218	216	530	528	345	343	805	803	615	611	1500	1496	875	868	2120	2113
224	222	545	543	355	353	825	823	630	626	1550	1546	900	893	2180	2173
230	228	560	558	365	363	850	848	650	646	1600	1596	925	918	2240	2233
236	234	580	578	375	373	875	873	670	666	1650	1646	950	943	2300	2293
243	241	600	598	387	385	900	898	690	686	1700	1696	975	968		
250	248	615	613	400	398	925	923	710	706	1750	1746	1000	993		
258	256	630	628	412	410	950	948	730	726	1800	1796	1030	1023		
265	263	650	648	425	423	975	973	750	746	1850	1846	1060	1053		
272	270	670	668	437	435	1000	998	775	771	1900	1896	1090	1083		
280	278	690	688	450	448	1030	1028	800	796	1950	1946	1120	1113		
290	288	710	708	462	460	1060	1058	825	821	2000	1996	1150	1143		
300	298	730	728	475	473	1090	1088	850	846	2060	2056	1180	1173		
307	305	750	748	487	485	1120	1118	875	871	2120	2116	1220	1213		
315	313			500	498	1150	1148	900	896	2180	2176	1250	1243		
325	323			515	513	1180	1178	925	921	2240	2236	1280	1273		
335	333			518	516	1220	1218	950	946	2300	2296	1320	1313		
345	343			530	528	1250	1248	975	971			1360	1353		
355	353			545	543	1280	1278	1000	996			1400	1393		
365	363			560	558	1320	1318	1030	1026			1450	1443		
375	373			580	578	1360	1358	1060	1056			1500	1493		
387	385			600	598	1400	1398	1090	1086			1550	1543		
400	398			615	613	1450	1448	1120	1116			1600	1593		
412	410			630	628	1500	1498	1150	1146			1650	1643		
425	423			650	648	1850	1848	1180	1176			1700	1693		

2. How to Design

Step 1. Determining conditions required for the design

- ① Machine type
- ② Transmission power, or rated power of the driving machine
- ③ Degree of load fluctuation
- ④ Daily operating hours
- ⑤ Speed ratio

$$\left(\frac{\text{Pinion revolution}}{\text{Revolution of large pulley}} \right)$$
- ⑥ Temporary center distance
- ⑦ Pulley diameter restriction
- ⑧ Operating environment (high temperature, low temperature, oil, water, dirt, acid, alkali)

Step 2. Calculating the design power

Calculate the design power with Formula 1.

Formula 1

$$P_d = P_t \times K_o$$

P_d : Design power (kW)
 P_t : Transmission power (kW) (Note 1)
 K_o : Load correction factor (Table 1)

Note 1) For transmission power, it is ideal to use the load of the driven machine; however, if it is unknown, use the rated power of the driving machine.
 If torque or horsepower is used for indication, convert it into watt or kilowatt using Formula 2.

Formula 2

$$P_t = \frac{Tr \times n}{9550}$$

P_t : Transmission power (kW) (Note 1)
 n : Revolution (rpm)
 Tr : Load torque (N·m)
 $1PS=0.7355(kW)$

Table 1 Load correction factors K_o

Driving machine \ Driven machine	Peak load less than 200%	Peak load 200% or more
	AC motor (Normal torque squirrel-cage type, synchronous)	
DC motor (shunt-wound)		DC motor (compound-wound, series-wound)
Engine / line shaft / clutch		
<ul style="list-style-type: none"> ● Fluid stirring machines ● Blowers ● Exhausters ● Centrifugal pumps ● Compact compressors ● Fans of 7.5 kW or less ● Lightweight conveyors 	1.2	1.3
<ul style="list-style-type: none"> ● Sand and grain conveyors ● Kneading mixers, laundry machines ● Fans of 7.5 kW or more ● Generators, rotary pumps ● Line shafts ○ Machine tools, printing machines ● Rotary/vibrating sieves 	1.3	1.4
<ul style="list-style-type: none"> ● Brick-processing machines ● Bucket elevators ● Exciters ● Piston pumps, compressors ● Papermaking mills, beadars ● Forced portable blowers ● Saw mills 	1.4	1.5
<ul style="list-style-type: none"> ● Sand pumps ● Crushers ● Mills (ball, rod, tube) ● Hoists ● Rubber calendars, extruders 	1.5	1.6

Step 3. Selecting a belt type

Obtain a belt type based on design power and pinion revolution from Fig. 1. If an obtained type is close to the line of intersection of two

types, design both belt types as a trial and choose the one that matches the purpose of the design and that is the more economical.

Fig. 1 Belt type selection diagram

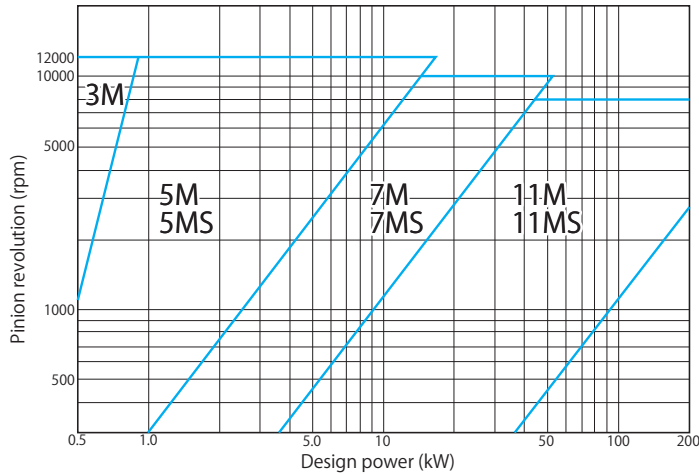

Step 4. Selecting a pulley diameter

Select an appropriate pulley diameter from Formula 3, taking the restriction of the power transmission space etc. into consideration.

$$Dp = \frac{n_1}{n_2} \times dp$$

$$\text{Speed ratio} = \frac{n_1}{n_2}$$

- dp : Pinion pitch diameter (mm)
- Dp : Large pulley pitch diameter (mm)
- n₁ : Pinion revolution (rpm)
- n₂ : Large pulley revolution (rpm)

The relationship between pulley outside diameter and pulley pitch diameter is based on Table 2.

Table 2 Difference between pulley outside diameter and pitch diameter 2k (Unit: mm)

Belt type	Single				Scrum		
	3M	5M	7M	11M	5MS	7MS	11MS
2K	-0.5	-0.9	-1.4	-2.1	1.0	1.4	1.0

Pulley pitch diameter = Pulley outside diameter + 2k

When you determine a pulley diameter, check the following items:

● Check of the minimum pulley pitch diameter

Generally, when a pulley with a small diameter is used, the flex fatigue of the belt increases, reducing the belt service life. Therefore, it is ideal to at least use a pulley diameter equal to or larger than the minimum pulley diameter indicated in Table 3.

Table 3 Minimum pulley pitch diameter (Unit: mm)

Belt type	Single				Scrum		
	3M	5M	7M	11M	5MS	7MS	11MS
Minimum pulley pitch diameter	17	26	40	63	26	40	63

● Check of the belt speed

Banfex and Banflescrum can normally be used up to 60 m/s. If the design exceeds 60 m/s, use a small pulley so that the belt speed is 60 m/s or less. If the minimum pulley diameter indicated in Table 3 is not satisfied, change and reconsider the belt type. Calculate the belt speed with Formula 4 (P. 284).

$$\text{Formula 4} \quad v = \frac{dp \times n}{19100}$$

- v : Belt speed (m/s)
- dp : Pinion pitch diameter (mm)
- n : Pinion revolution (rpm)

Step 5. Selecting an effective length

① Determination of the effective length

Calculate a rough effective length L' with Formula 5 and select an effective length that is closest to this value from the "Table of standard effective lengths" (→ P. 280 to P. 281).

$$\text{Formula 5} \quad L' = 2C + 1.57(Dp + dp) + \frac{(Dp - dp)^2}{4C}$$

- L' : Rough effective length (mm)
- C : Center distance (mm)
- Dp : Large pulley pitch diameter (mm)
- dp : Pinion pitch diameter (mm)

② Calculation of the center distance

From the selected pitch length, backcalculate the center distance with Formula 6.

$$\text{Formula 6} \quad C = \frac{B + \sqrt{B^2 - 2(Dp - dp)^2}}{4}$$

$$B = Lp - 1.57(Dp + dp)$$

- Lp : Belt pitch length (mm)
- Dp : Large pulley pitch diameter (mm)
- dp : Pinion pitch diameter (mm)

Step 6. Calculating the number of belts

① Determination of the basic power rating

Obtain the basic power rating for the pinion pitch diameter and its revolution from the tables of basic power ratings (P. 285 to P. 288).

② Correction of the basic power rating

From Formula 7, obtain the angle of contact of the pinion θ₁ and from Table 4, obtain the correction factor (Kθ₁).

$$\text{Formula 7} \quad \theta_{11} = 180 - \frac{57(Dp - dp)}{C}$$

- θ₁ : Angle of contact of pinion (°)
- Dp : Large pulley pitch diameter (mm)
- dp : Pinion pitch diameter (mm)
- C : Center distance (mm)

Table 4 Pinion contact angle correction factors Kθ₁

Dp-dp / C	Angle of contact of pinion (°)	Kθ ₁	Dp-dp / C	Angle of contact of pinion (°)	Kθ ₁	Dp-dp / C	Angle of contact of pinion (°)	Kθ ₁
0.00	180	1.00	0.60	145	0.91	1.20	106	0.77
0.10	174	0.99	0.70	139	0.89	1.30	99	0.73
0.20	169	0.97	0.80	133	0.87	1.40	91	0.70
0.30	163	0.96	0.90	127	0.85	1.50	83	0.65
0.40	157	0.94	1.00	120	0.82			
0.50	151	0.93	1.10	113	0.80			

③ Calculating the number of ridges of belt

Calculate the number of belt ridges (or belts) with Formula 8. Round up the figures after the decimal point to an integer.

$$\text{Formula 8} \quad N = \frac{Pd}{Pr \times K\theta_1}$$

- N : Number of belt ridges (or belts)
- Pd : Design power (kW)
- Pr : Basic power rating (kW)

Step 7. Checking the adjustment range of the center distance

From Table 5, obtain the installation range and the tension range of the belt.

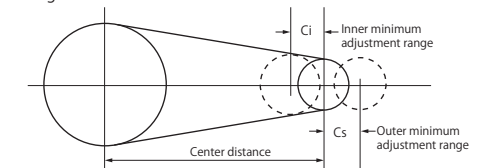

Table 5 Table of adjustment ranges of center distance (Unit: mm)

Nominal length	Inner minimum adjustment range Ci	Outer minimum adjustment range Cs
180~272	4.5	4.5
280~710	10.0	10.0
730~1090	12.5	15.0
1120~1500	14.0	19.0
1550~1900	16.5	23.0
1950~2300	19.0	26.5

Table of basic power ratings for Type 3M

(Unit: kW)

Pinion revolution (rpm)	Pinion pitch diameter (mm)															
	17	18	19	20	21	22	23	24	25	26	28	30	35	40	45	50
1000	0.03	0.04	0.04	0.05	0.06	0.07	0.07	0.08	0.09	0.10	0.11	0.13	0.15	0.17	0.18	0.20
1200	0.03	0.04	0.05	0.06	0.07	0.07	0.08	0.09	0.10	0.11	0.13	0.15	0.17	0.19	0.21	0.23
1400	0.03	0.04	0.05	0.06	0.07	0.08	0.09	0.10	0.11	0.12	0.14	0.17	0.20	0.22	0.23	0.25
1600	0.03	0.04	0.05	0.06	0.08	0.09	0.10	0.11	0.12	0.13	0.16	0.18	0.22	0.24	0.26	0.28
1800	0.03	0.04	0.05	0.07	0.08	0.09	0.11	0.12	0.13	0.15	0.17	0.20	0.23	0.26	0.28	0.30
2000	0.02	0.04	0.05	0.07	0.08	0.10	0.11	0.13	0.14	0.15	0.18	0.21	0.25	0.28	0.30	0.32
2500		0.04	0.05	0.07	0.09	0.11	0.12	0.14	0.16	0.18	0.21	0.25	0.29	0.32	0.34	0.37
3000		0.03	0.05	0.07	0.09	0.11	0.13	0.15	0.17	0.19	0.24	0.28	0.33	0.36	0.38	0.41
3500		0.02	0.05	0.07	0.09	0.12	0.14	0.16	0.19	0.21	0.26	0.30	0.36	0.39	0.42	0.45
4000		0.02	0.04	0.07	0.10	0.12	0.15	0.17	0.20	0.22	0.28	0.33	0.39	0.42	0.46	0.48
4500			0.04	0.07	0.10	0.12	0.15	0.18	0.21	0.24	0.30	0.35	0.42	0.46	0.49	0.52
5000			0.03	0.06	0.10	0.13	0.16	0.19	0.22	0.25	0.31	0.37	0.45	0.48	0.52	0.55
5500			0.03	0.06	0.10	0.13	0.16	0.20	0.23	0.26	0.33	0.40	0.47	0.51	0.55	0.58
6000			0.02	0.06	0.09	0.13	0.17	0.20	0.24	0.27	0.34	0.42	0.50	0.54	0.58	0.61
6500				0.05	0.09	0.13	0.17	0.21	0.24	0.28	0.36	0.43	0.52	0.56	0.60	0.64
7000				0.05	0.09	0.13	0.17	0.21	0.25	0.29	0.37	0.45	0.55	0.59	0.63	0.67
7500				0.05	0.09	0.13	0.17	0.22	0.26	0.30	0.39	0.47	0.57	0.61	0.66	0.70
8000			0.04	0.09	0.13	0.18	0.22	0.26	0.31	0.40	0.49	0.59	0.64	0.68	0.72	
8500				0.08	0.13	0.18	0.22	0.27	0.32	0.41	0.50	0.61	0.66	0.70	0.75	
9000				0.08	0.13	0.18	0.23	0.28	0.32	0.42	0.52	0.63	0.68	0.73	0.77	
9500				0.08	0.13	0.18	0.23	0.28	0.33	0.43	0.54	0.65	0.70	0.75	0.80	
10000				0.07	0.13	0.18	0.23	0.29	0.34	0.45	0.55	0.67	0.72	0.77	0.82	
10500					0.13	0.18	0.24	0.29	0.35	0.46	0.57	0.69	0.74	0.79	0.84	
11000					0.12	0.18	0.24	0.30	0.35	0.47	0.58	0.71	0.76	0.82	0.87	
11500					0.12	0.18	0.24	0.30	0.36	0.48	0.59	0.73	0.78	0.84	0.89	
12000						0.12	0.18	0.24	0.30	0.36	0.49	0.61	0.74	0.80	0.86	0.91

Table of basic power ratings for Types 5M and 5MS

(Unit: kW)

Pinion revolution (rpm)	Pinion pitch diameter (mm)																
	26	28	30	32	34	36	38	40	42	44	46	48	50	60	70	80	90
500	0.01	0.03	0.05	0.06	0.08	0.10	0.12	0.13	0.15	0.17	0.19	0.20	0.22	0.28	0.33	0.38	0.43
600	0.02	0.04	0.07	0.09	0.11	0.13	0.15	0.17	0.19	0.21	0.24	0.26	0.28	0.34	0.40	0.46	0.51
700	0.03	0.06	0.08	0.11	0.13	0.16	0.18	0.21	0.23	0.26	0.28	0.31	0.33	0.40	0.46	0.52	0.58
800	0.04	0.07	0.10	0.12	0.15	0.18	0.21	0.24	0.27	0.30	0.32	0.35	0.38	0.46	0.52	0.59	0.65
900	0.05	0.08	0.11	0.14	0.17	0.20	0.24	0.27	0.30	0.33	0.36	0.40	0.43	0.51	0.58	0.65	0.72
1000	0.05	0.09	0.12	0.16	0.19	0.23	0.26	0.30	0.33	0.37	0.40	0.44	0.47	0.56	0.64	0.71	0.79
1200	0.06	0.10	0.14	0.18	0.22	0.27	0.31	0.35	0.39	0.43	0.47	0.52	0.56	0.65	0.74	0.83	0.91
1400	0.06	0.11	0.16	0.21	0.26	0.30	0.35	0.40	0.45	0.49	0.54	0.59	0.64	0.74	0.84	0.94	1.03
1600	0.07	0.12	0.18	0.23	0.28	0.34	0.39	0.44	0.50	0.55	0.61	0.66	0.71	0.83	0.94	1.04	1.14
1800	0.07	0.13	0.19	0.25	0.31	0.37	0.43	0.49	0.55	0.61	0.67	0.73	0.79	0.91	1.03	1.14	1.25
2000	0.07	0.14	0.20	0.27	0.33	0.40	0.46	0.53	0.59	0.66	0.73	0.79	0.86	0.99	1.11	1.23	1.35
2200	0.07	0.14	0.22	0.29	0.36	0.43	0.50	0.57	0.64	0.71	0.78	0.85	0.92	1.07	1.20	1.33	1.45
2400	0.07	0.15	0.23	0.30	0.38	0.46	0.53	0.61	0.68	0.76	0.84	0.91	0.99	1.14	1.28	1.42	1.55
2600	0.07	0.16	0.24	0.32	0.40	0.48	0.56	0.64	0.73	0.81	0.89	0.97	1.05	1.21	1.36	1.50	1.64
2800	0.07	0.16	0.25	0.33	0.42	0.51	0.59	0.68	0.77	0.85	0.94	1.03	1.11	1.28	1.44	1.59	1.73
3000	0.07	0.16	0.26	0.35	0.44	0.53	0.62	0.72	0.81	0.90	0.99	1.08	1.18	1.35	1.52	1.67	1.82
3500	0.07	0.17	0.28	0.38	0.49	0.59	0.69	0.80	0.90	1.01	1.11	1.22	1.32	1.52	1.70	1.87	2.04
4000	0.06	0.18	0.30	0.41	0.53	0.64	0.76	0.88	0.99	1.11	1.23	1.34	1.46	1.67	1.87	2.07	2.25
4500	0.05	0.18	0.31	0.44	0.57	0.70	0.82	0.95	1.08	1.21	1.34	1.47	1.59	1.82	2.04	2.25	2.45
5000	0.05	0.19	0.33	0.47	0.60	0.74	0.88	1.02	1.16	1.30	1.44	1.58	1.72	1.97	2.21	2.43	2.64
5500		0.19	0.34	0.49	0.64	0.79	0.94	1.09	1.24	1.40	1.55	1.70	1.85	2.11	2.36	2.60	2.83
6000		0.19	0.35	0.51	0.67	0.84	1.00	1.16	1.32	1.48	1.65	1.81	1.97	2.25	2.52	2.77	3.01
6500		0.19	0.36	0.53	0.70	0.88	1.05	1.22	1.40	1.57	1.74	1.92	2.09	2.38	2.66	2.93	3.19
7000		0.18	0.37	0.55	0.74	0.92	1.10	1.29	1.47	1.65	1.84	2.02	2.21	2.52	2.81	3.09	3.36
7500		0.18	0.38	0.57	0.76	0.96	1.15	1.35	1.54	1.74	1.93	2.12	2.32	2.64	2.95	3.25	3.53
8000		0.18	0.38	0.59	0.79	1.00	1.20	1.41	1.61	1.82	2.02	2.22	2.43	2.77	3.09	3.40	3.70
8500		0.17	0.39	0.60	0.82	1.03	1.25	1.46	1.68	1.89	2.11	2.32	2.54	2.89	3.23	3.55	3.86
9000		0.17	0.39	0.62	0.84	1.07	1.29	1.52	1.74	1.97	2.19	2.42	2.64	3.01	3.36	3.70	4.02
9500		0.17	0.40	0.63	0.87	1.10	1.34	1.57	1.81	2.04	2.28	2.51	2.75	3.13	3.49	3.84	4.17
10000		0.16	0.40	0.65	0.89	1.14	1.38	1.63	1.87	2.12	2.36	2.61	2.85	3.25	3.62	3.98	4.32
10500		0.15	0.41	0.66	0.92	1.17	1.43	1.68	1.93	2.19	2.44	2.70	2.95	3.36	3.75	4.12	4.47
11000		0.15	0.41	0.68	0.94	1.20	1.47	1.73	2.00	2.26	2.52	2.79	3.05	3.47	3.87	4.26	4.62
11500		0.14	0.41	0.69	0.96	1.24	1.51	1.78	2.06	2.33	2.60	2.88	3.15	3.59	4.00	4.39	4.77
12000		0.13	0.42	0.70	0.98	1.27	1.55	1.83	2.12	2.40	2.68	2.96	3.25	3.70	4.12	4.52	4.91

Table of basic power ratings for Types 7M and 7MS

(Unit: kW)

Pinion revolution (rpm)	Pinion pitch diameter (mm)																
	40	42	44	46	48	50	55	60	70	80	90	100	110	130	150	175	200
500	0.05	0.07	0.09	0.12	0.14	0.16	0.22	0.28	0.40	0.51	0.65	0.78	0.90	1.12	1.32	1.56	1.78
600	0.06	0.10	0.13	0.16	0.20	0.23	0.31	0.40	0.56	0.73	0.88	1.01	1.14	1.38	1.60	1.86	2.11
700	0.08	0.12	0.16	0.20	0.25	0.29	0.39	0.50	0.71	0.92	1.08	1.22	1.36	1.62	1.86	2.15	2.41
800	0.09	0.14	0.19	0.24	0.29	0.34	0.47	0.59	0.85	1.10	1.26	1.42	1.57	1.85	2.11	2.41	2.70
900	0.10	0.16	0.22	0.27	0.33	0.39	0.54	0.68	0.97	1.26	1.44	1.60	1.76	2.06	2.34	2.67	2.98
1000	0.11	0.17	0.24	0.30	0.37	0.44	0.60	0.76	1.09	1.42	1.60	1.78	1.95	2.26	2.56	2.91	3.24
1200	0.12	0.20	0.28	0.36	0.44	0.52	0.72	0.92	1.31	1.71	1.91	2.11	2.29	2.65	2.98	3.37	3.74
1400	0.14	0.23	0.32	0.41	0.51	0.60	0.83	1.06	1.52	1.98	2.20	2.41	2.62	3.01	3.37	3.80	4.21
1600	0.15	0.25	0.36	0.46	0.57	0.67	0.93	1.19	1.71	2.23	2.47	2.70	2.92	3.35	3.74	4.21	4.66
1800	0.16	0.28	0.39	0.51	0.62	0.74	1.03	1.32	1.89	2.47	2.73	2.98	3.22	3.67	4.10	4.60	5.08
2000	0.17	0.30	0.42	0.55	0.68	0.80	1.12	1.44	2.07	2.70	2.98	3.24	3.50	3.98	4.44	4.98	5.49
2200	0.18	0.32	0.45	0.59	0.73	0.86	1.21	1.55	2.24	2.92	3.22	3.50	3.77	4.28	4.76	5.34	5.88
2400	0.19	0.33	0.48	0.63	0.78	0.92	1.29	1.66	2.40	3.14	3.45	3.74	4.03	4.57	5.08	5.69	6.26
2600	0.19	0.35	0.51	0.67	0.82	0.98	1.38	1.77	2.56	3.35	3.67	3.98	4.28	4.85	5.39	6.02	6.63
2800	0.20	0.37	0.54	0.70	0.87	1.04	1.46	1.87	2.71	3.55	3.89	4.21	4.53	5.12	5.69	6.35	6.98
3000	0.21	0.38	0.56	0.74	0.91	1.09	1.53	1.97	2.86	3.74	4.10	4.44	4.76	5.39	5.98	6.67	7.33
3500	0.22	0.42	0.62	0.82	1.02	1.22	1.72	2.22	3.21	4.21	4.60	4.98	5.34	6.02	6.67	7.44	8.17
4000	0.23	0.45	0.68	0.90	1.12	1.34	1.89	2.44	3.55	4.66	5.08	5.49	5.88	6.63	7.33	8.17	8.95
4500	0.24	0.49	0.73	0.97	1.21	1.45	2.06	2.66	3.87	5.08	5.54	5.98	6.40	7.20	7.96	8.86	9.70
5000	0.25	0.51	0.78	1.04	1.30	1.56	2.22	2.87	4.18	5.49	5.98	6.45	6.90	7.76	8.56	9.52	10.42
5500	0.26	0.54	0.82	1.10	1.38	1.66	2.37	3.07	4.48	5.88	6.40	6.90	7.38	8.29	9.14	10.16	11.11
6000	0.27	0.57	0.87	1.16	1.46	1.76	2.51	3.26	4.76	6.26	6.81	7.33	7.84	8.80	9.70	10.77	
6500	0.27	0.59	0.91	1.22	1.54	1.86	2.65	3.45	5.04	6.63	7.20	7.76	8.29	9.30	10.24	11.36	
7000	0.28	0.61	0.95	1.28	1.62	1.95	2.79	3.63	5.31	6.98	7.59	8.17	8.72	9.78	10.77		
7500	0.28	0.63	0.98	1.34	1.69	2.04	2.92	3.81	5.57	7.33	7.96	8.56	9.14	10.24	11.28		
8000	0.28	0.65	1.02	1.39	1.76	2.13	3.05	3.98	5.82	7.67	8.33	8.95	9.56	10.70			
8500	0.28	0.67	1.06	1.44	1.83	2.21	3.18	4.14	6.07	8.00	8.68	9.33	9.96	11.14			
9000	0.29	0.69	1.09	1.49	1.89	2.30	3.30	4.31	6.32	8.33	9.03	9.70	10.35				
9500	0.29	0.70	1.12	1.54	1.96	2.38	3.42	4.46	6.55	8.64	9.37	10.07	10.74				
10000	0.29	0.72	1.15	1.59	2.02	2.45	3.54	4.62	6.79	8.95	9.70	10.42	11.11				

Table of basic power ratings for Types 11M and 11MS

(Unit: kW)

Pinion revolution (rpm)	Pinion pitch diameter (mm)																
	63	65	70	75	80	85	90	100	110	120	130	140	150	180	210	250	300
500	0.50	0.54	0.64	0.75	0.85	0.95	1.06	1.26	1.47	1.68	1.93	2.22	2.49	3.23	3.90	4.73	5.67
600	0.64	0.70	0.84	0.99	1.14	1.29	1.44	1.74	2.04	2.34	2.64	2.94	3.23	4.03	4.77	5.67	6.72
700	0.76	0.84	1.03	1.22	1.41	1.60	1.79	2.16	2.54	2.92	3.28	3.60	3.90	4.77	5.56	6.55	7.69
800	0.88	0.97	1.20	1.42	1.65	1.88	2.10	2.55	3.01	3.46	3.86	4.20	4.53	5.45	6.31	7.37	8.60
900	0.99	1.09	1.35	1.61	1.88	2.14	2.40	2.92	3.44	3.96	4.41	4.77	5.12	6.10	7.02	8.15	9.46
1000	1.09	1.21	1.50	1.80	2.09	2.38	2.68	3.26	3.85	4.43	4.92	5.30	5.67	6.72	7.69	8.89	10.29
1200	1.28	1.42	1.78	2.13	2.49	2.84	3.19	3.90	4.61	5.32	5.89	6.31	6.72	7.87	8.95	10.29	11.84
1400	1.46	1.62	2.03	2.44	2.85	3.26	3.68	4.50	5.32	6.14	6.78	7.24	7.69	8.95	10.13	11.59	13.28
1600	1.62	1.81	2.27	2.73	3.20	3.66	4.12	5.05	5.98	6.91	7.62	8.12	8.60	9.96	11.23	12.81	14.63
1800	1.77	1.98	2.49	3.01	3.52	4.03	4.55	5.58	6.61	7.64	8.42	8.95	9.46	10.92	12.28	13.96	15.91
2000	1.91	2.14	2.70	3.27	3.83	4.39	4.95	6.08	7.20	8.33	9.18	9.74	10.29	11.84	13.28	15.07	17.13
2200	2.05	2.29	2.90	3.51	4.12	4.73	5.34	6.56	7.78	8.99	9.91	10.50	11.08	12.71	14.23	16.12	18.29
2400	2.18	2.44	3.09	3.75	4.40	5.06	5.71	7.02	8.33	9.63	10.61	11.23	11.84	13.55	15.15	17.13	19.41
2600	2.30	2.58	3.28	3.97	4.67	5.37	6.07	7.46	8.86	10.25	11.28	11.94	12.57	14.37	16.04	18.10	20.48
2800	2.42	2.71	3.45	4.19	4.93	5.67	6.41	7.89	9.37	10.85	11.94	12.62	13.28	15.15	16.89	19.04	21.51
3000	2.53	2.84	3.62	4.40	5.18	5.96	6.74	8.30	9.86	11.43	12.57	13.28	13.96	15.91	17.72	19.95	22.51
3200	2.64	2.96	3.78	4.60	5.43	6.25	7.07	8.71	10.35	11.99	13.18	13.92	14.63	16.65	18.52	20.83	23.48
3400	2.74	3.08	3.94	4.80	5.66	6.52	7.38	9.10	10.82	12.53	13.78	14.54	15.28	17.37	19.30	21.68	24.41
3600	2.84	3.20	4.09	4.99	5.89	6.79	7.68	9.48	11.27	13.07	14.37	15.15	15.91	18.07	20.06	22.51	25.32
3800	2.93	3.31	4.24	5.18	6.11	7.05	7.98	9.85	11.72	13.59	14.94	15.75	16.53	18.75	20.80	23.32	26.20
4000	3.03	3.41	4.39	5.36	6.33	7.30	8.27	10.21	12.15	14.10	15.49	16.33	17.13	19.41	21.51	24.10	
4500	3.24	3.67	4.73	5.78	6.84	7.90	8.96	11.08	13.20	15.32	16.83	17.72	18.58	21.00	23.24	25.98	
5000	3.44	3.90	5.04	6.19	7.33	8.47	9.62	11.90	14.19	16.48	18.10	19.04	19.95	22.51	24.87		
5500	3.63	4.12	5.34	6.57	7.79	9.01	10.24	12.69	15.14	17.59	19.32	20.31	21.26	23.95			
6000	3.80	4.32	5.62	6.92	8.23	9.53	10.83	13.44	16.04	18.65	20.48	21.51	22.51	25.32			
6500	3.96	4.51	5.89	7.26	8.64	10.02	11.40	14.15	15.91	19.67	21.60	22.67	23.71				
7000	4.10	4.68	6.14	7.59	9.04	10.49	11.94	14.84	17.75	20.65	22.67	23.79	24.87				
7500	4.24	4.85	6.37	7.89	9.42	10.94	12.46	15.51	18.55	21.60	23.71	24.87	25.98				
8000	4.37	5.01	6.60	8.19	9.78	11.37	12.96	16.15	19.33	22.51	24.71	25.91					

Step 1. Determining conditions required for the design

Driven machine: Viscous torque testing machine
 - Motor power: 5.5 kW/2600 rpm
 - Driving pulley outside diameter: 99.0 mm
 - Driven pulley revolution: 6500 rpm
 - Center distance: 550±20 mm
 - Use Banflescrum.

Step 2. Calculating the design power

- Obtain the load correction factor from **Table 1** (→ P. 282).
From a similar machine (kneading mixer), take $K_0 = 1.4$.
- From **Formula 1** (→ P. 282), calculate the design power.
 $P_d = 5.5 \times 1.4 = 7.7$ (kW)

Step 3. Selecting a belt type

Select MS from the design power of 7.7 kW and the pinion revolution of 6500 rpm from **Fig. 1** (→ P. 283).

Step 4. Selecting a pulley diameter

- From **Table 2** (→ P. 283), obtain the large pulley pitch diameter.
 $D_p = 99.0 + 1.0 = 100$ mm
- From **Formula 3** (→ P. 283), obtain the pinion pitch diameter.
 $d_p = \frac{2600}{6500} \times 100 = 40$ mm
- From **Table 3** (→ P. 283), satisfy the minimum pulley pitch diameter.
- The belt speed is
 $v = \frac{40 \times 6500}{19100} = 13.6$ m/s
This falls sufficiently within 60 m/s.

Step 5. Selecting an effective length

- Calculate a **rough effective length L'** (→ P. 284) and select an effective length that is closest to this value from the "Standard effective lengths (Banflescrum)" (→ P. 280).
 $L' = 2 \times 550 + 1.57(100 + 40) + \frac{(100 - 40)^2}{4 \times 550}$
 $\approx 1321.4 \rightarrow 1317$ mm
- From the belt pitch length of 1317 and **Formula 6** (→ P. 284), backcalculate the center distance at that time.
 $B = 1317 - 1.57(100 + 40) = 1097.2$
 $C = \frac{1097.2 + \sqrt{1097.2^2 - 2(100 - 40)^2}}{4}$
 ≈ 547.8 mm

Step 6. Determining the number of belts

- Obtain the **basic power rating for the pinion revolution of 6500 rpm and the pinion pitch diameter of 40 mm** from the table of basic power ratings for Type 5MS (P. 286).
- From **Formula 7** (→ P. 284), calculate the pinion contact angle θ_1 and from **Table 4** (→ P. 284), obtain its correction factor.
 $\theta_1 = 180 - \frac{57(100 - 40)}{547.8} \approx 174^\circ$
 $K\theta_1 = 0.99$
- Calculate the number of belt ridges with **Formula 8** (→ P. 284).
 $N = \frac{7.7}{1.22 \times 0.99} = 6.4 \rightarrow 7$

Step 7. Checking the adjustment range of the center distance

From **Table 5** (→ P. 284), obtain the inner and outer minimum adjustment ranges of the center distance.

Examination result

- Belt 7-5MS1320
 - Driving pulley pitch diameter: 100 mm
 - Driven pulley pitch diameter: 40 mm
 - Center distance 547.8 mm
 [Inner minimum adjustment range: 14 mm
 Outer minimum adjustment range: 19 mm

Load correction factor $K_0 = 1.4$

Design power $P_d = 7.7$ (kW)

Belt type: 5MS

Large-pulley pitch diameter: 100 mm

Pinion pitch diameter: 40 mm

Effective length: 5MS1320

Center distance: 547.8 mm

Basic power rating = 1.22 kW

Correction factor $K\theta_1 = 0.99$

Number of belt ridges = 7

Inner minimum adjustment range (Ci) = 14 mm
 Outer maximum adjustment range (Cs) = 19 mm

3. Banflescrum Pulley/Banflex Pulley

For Banflex and Banflescrum pulleys, please use the ones with the dimensions shown in the following table. We also manufacture pulleys; please contact us.

Dimensional accuracy

■ Profile of the groove section

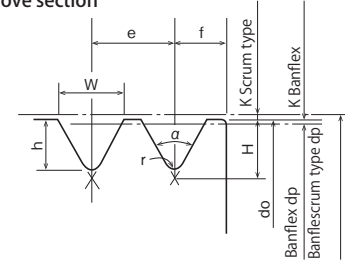

■ Groove dimensions

Type	W ±0.05	e +0.13 -0.05	f min	Groove angle		h with rmax	H	r max	K						
				Outside diameter do	α ± 1/4 (°)										
3M	2.80	3.35	2.23	17.5 to 18 or less	60	2.12	2.42	0.3	-0.25						
				18 to 32 or less	61	2.09	2.38								
				33 or more	62	2.05	2.33								
5M	4.50	5.30	3.5	25 to 28 or less	60	3.50	3.90	0.4	-0.45						
				28 to 38 or less	61	3.43	3.82								
				38 to 62 or less	62	3.37	3.74								
5MS	4.50	5.30	3.5	62 or more	63	3.31	3.67	0.5	0.5						
				7M	7.10	8.50	5.7			38 to 44 or less	59	5.66	6.27	0.6	-0.70
										44 to 62 or less	60	5.55	6.15		
7MS	7.10	8.50	5.7	62 to 100 or less	61	5.44	6.03	0.8	0.7						
				100 or more	62	5.34	5.91								
				11M	11.20	13.20	8.6			60 to 80 or less	60	8.90	9.70	0.8	-1.05
80 to 120 or less	61	8.73	9.51												
120 to 238 or less	62	8.57	9.32												
11MS	11.20	13.20	8.6	238 or more	63	8.41	9.14	0.5	0.5						

■ Run-out of outside diameter and side face (outside diameter and side face)

Product No. Pulley outside diameter	Pulley for Banflex			Pulley for Banscrum		
	Outside diameter tolerance	Outside diameter run-out tolerance	Side face run-out tolerance	Outside diameter tolerance	Outside diameter run-out tolerance	Side face run-out tolerance
25 or less	±0.03	0.13	0.03	-	-	-
25 to 50 or less	±0.05	0.13	0.06	±0.15	0.15	0.15
50 to 126 or less	±0.13	0.13	0.13	±0.15	0.15	0.15
126 to 250 or less	±0.25	0.13	0.13	±0.25	0.20	0.20
250 to 500 or less	±0.50	Add 0.01 for every increase of outside diameter of 25 mm.	0.20	±0.50	0.25	0.25
500 or more	±1.00		0.25	±1.00	0.35	0.35

(Note) When the side face of the groove is high-frequency-quenched uniformly to a depth of 1 mm or more and to approximately a surface hardness of HRC55, the abrasion resistance of the pulley improves.

■ Roughness of side face of groove

As finish accuracy, perform finishing to 3.2a or less (10·S (JIS)).

■ Pulley material

As a material, please use S45C or SS410. However, when the pulley diameter is 100 mm or more, FC250 or more can also be used.

Reference Profiles and Dimensions of Banfle Pulleys

We also manufacture pulleys. Please make use of the following table as reference profiles and dimensions when you make a design.

(Pulley Profile) Type B

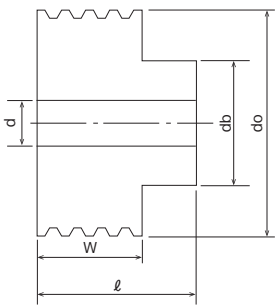

Type D

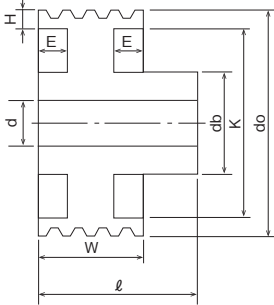

(Banfle Pulley Designation)

(Example) ● Pulley for Banflescrum
100 × 7MS - 4
Pulley outside diameter (100 mm) Belt type (Type 7MS) No. of grooves (4 grooves)

● Pulley for Banflex
20 × 3M
Pulley outside diameter (20 mm) Belt type (Type 3M)

Table of Standard Dimensions of Pulley for Banflescrum (Reference)

Pulley for 5MS (non-stocked product)

(Unit: mm)

Nominal outside diameter do	Pitch diameter dp	Profile	Material	For two ridges			For three ridges			db	d min	d max	H	K
				W	l	E	W	l	E					
30	31.0	B	Carbon steel for machine construction	12.3	27	—	17.6	35	—	Center marking	7	—	—	
40	41.0	↑		↑	↑	—	↑	↑	—		25	10	—	—
50	51.0	↑		↑	↑	—	↑	↑	—	30	6	15	—	
60	61.0	↑		↑	↑	—	↑	↑	—	35	8	16	—	
70	71.0	↑		↑	↑	—	↑	↑	—	45	8	22	—	
80	81.0	↑		↑	↑	—	↑	↑	—	50	10	28	—	
90	91.0	↑		↑	↑	—	↑	↑	—	60	10	32	—	

Pulley for 7MS (non-stocked product)

(Unit: mm)

Nominal outside diameter do	Pitch diameter dp	Profile	Material	For two ridges			For three ridges			For four ridges			db	d min	d max	H	K
				W	l	E	W	l	E	W	l	E					
70	71.4	B	Carbon steel for machine construction	19.9	40	—	28.4	50	—	36.9	62	—	45	8	22	—	—
90	91.4	↑		↑	↑	—	↑	↑	—	↑	↑	—	60	10	32	—	—
110	111.4	↑		↑	↑	—	↑	↑	—	↑	↑	—	70	12	40	—	—
130	131.4	↑		↑	↑	—	↑	↑	—	↑	↑	—	80	12	45	—	—
150	151.4	↑		↑	45	—	↑	55	—	↑	↑	—	90	15	50	—	—
175	176.4	D		↑	↑	5	↑	↑	9	↑	↑	12	100	15	55	13	149
200	201.4	↑		↑	↑	↑	↑	↑	↑	↑	↑	105	20	58	13	174	

(Note) ① "d min" represents "pilot hole dimension" or "center marking" at the time of manufacture at our company.

For center marking, the nominal dimension is 2.5 or less. (JIS B1011-1987 60° center hole)

② "d max" is the maximum dimension in machining.

③ These are reference profiles and dimensions; when you place an order to us, please provide drawings.

Pulley for 11MS (non-stocked product)

(Unit: mm)

Nominal outside diameter do	Pitch diameter dp	Profile	Material	For two ridges			For four ridges			For six ridges			db	d min	d max	H	K
				W	l	E	W	l	E	W	l	E					
80	81.0	B	Carbon steel for machine construction	30.4	52	—	—	—	—	—	—	—	50	12	28	—	—
100	101.0	↑		↑	↑	—	56.8	82	—	83.2	108	—	65	15	35	—	—
120	121.0	↑		↑	↑	—	↑	↑	—	↑	↑	—	75	15	42	—	—
150	151.0	↑		↑	55	—	↑	87	—	↑	113	—	90	15	50	—	—
180	181.0	D		↑	↑	10	↑	↑	20	↑	↑	31	100	20	55	20	140
210	211.0	↑		↑	↑	↑	↑	↑	↑	↑	↑	↑	110	20	60	↑	170
250	251.0	↑		↑	↑	↑	↑	↑	↑	↑	↑	↑	120	20	65	↑	210
300	301.0	↑		—	—	—	↑	↑	↑	↑	↑	↑	130	25	70	↑	260

Table of Standard Dimensions of Pulley for Banflex (Reference)

Pulley for 3M (non-stocked product)

(Unit: mm)

Nominal outside diameter do	Pitch diameter dp	Profile	Material	W	l	db	d min	d max	H	E	K	
												20
25	24.5	B	4.46	15	15	5	—	—	—			
30	29.5	B	4.46	15	20	7	—	—	—			
35	34.5	B	4.46	15	25	10	—	—	—			
40	39.5	B	4.46	15	25	10	—	—	—			
45	44.5	B	4.46	15	30	15	—	—	—			
50	49.5	B	4.46	15	30	6	15	—	—	—		

Pulley for 5M (non-stocked product)

(Unit: mm)

Nominal outside diameter do	Pitch diameter dp	Profile	Material	W	l	db	d min	d max	H	E	K	
												30
40	39.1	B	7.0	19	25	25	10	—	—			
50	49.1	B	7.0	19	30	6	30	15	—	—		
60	59.1	B	7.0	19	35	8	35	18	—	—		
70	69.1	B	7.0	19	45	8	45	22	—	—		
80	79.1	B	7.0	19	50	10	50	28	—	—		
90	89.1	B	7.0	19	60	10	60	32	—	—		

Pulley for 7M (non-stocked product)

(Unit: mm)

Nominal outside diameter do	Pitch diameter dp	Profile	Material	W	l	db	d min	d max	H	E	K
90	88.6	B	11.4	25	60	10	32	—	—	—	
110	108.6	B	11.4	25	70	12	40	—	—	—	
130	128.6	B	11.4	25	80	12	45	—	—	—	
150	148.6	B	11.4	27	90	15	50	—	—	—	
175	173.6	D	11.4	27	100	15	55	12	3.5	151	
200	198.6	D	11.4	27	105	20	58	12	3.5	176	

Pulley for 11M (non-stocked product)

(Unit: mm)

Nominal outside diameter do	Pitch diameter dp	Profile	Material	W	l	db	d min	d max	H	E	K
100	97.9	B	17.2	33	65	12	35	—	—	—	
120	117.9	B	17.2	33	75	12	42	—	—	—	
150	147.9	B	17.2	33	90	15	50	—	—	—	
180	177.9	D	17.2	33	100	15	55	20	5	140	
210	207.9	D	17.2	33	110	20	60	20	5	170	
250	247.9	D	17.2	33	120	20	65	20	5	210	