

## Right choice for ultimate yield

LSIS strives to maximize customers' profit in gratitude of choosing us for your partner.

Programmable Logic Controller

# XGK CPU Module

XGT Series

User's Manual

XGK-CPUUN

XGK-CPUHN

XGK-CPUSN

XGK-CPUU

XGK-CPUH

XGK-CPUA

XGK-CPUS

XGK-CPUE



### Safety Instructions

- Read this manual carefully before installing, wiring, operating, servicing or inspecting this equipment.
- Keep this manual within easy reach for quick reference.

**LS** Industrial Systems

<http://www.lsis.com>

# Safety Instruction

## Before using the product ...

For your safety and effective operation, please read the safety instructions thoroughly before using the product.

- ▶ Safety Instructions should always be observed in order to prevent accident or risk with the safe and proper use the product.
- ▶ Instructions are separated into “Warning” and “Caution”, and the meaning of the terms is as follows;





### **Warning**

WARNING indicates a potentially hazardous situation which, if not avoided, could result in death or serious injury



### **Caution**

CAUTION indicates a potentially hazardous situation which, if not avoided, may result in minor or moderate injury. It may also be used to alert against unsafe practices

- ▶ The marks displayed on the product and in the user’s manual have the following meanings.
  -  Be careful! Danger may be expected.
  -  Be careful! Electric shock may occur.
- ▶ The user’s manual even after read shall be kept available and accessible to any user of the product.

# Safety Instruction

## Safety Instructions when designing

### **Warning**

- ▶ **Please, install protection circuit on the exterior of PLC to protect the whole control system from any error in external power or PLC module.** Any abnormal output or operation may cause serious problem in safety of the whole system.
  - Install applicable protection unit on the exterior of PLC to protect the system from physical damage such as emergent stop switch, protection circuit, the upper/lowest limit switch, forward/reverse operation interlock circuit, etc.
  - If any system error (watch-dog timer error, module installation error, etc.) is detected during CPU operation in PLC, the whole output is designed to be turned off and stopped for system safety. However, in case CPU error if caused on output device itself such as relay or TR can not be detected, the output may be kept on, which may cause serious problems. Thus, you are recommended to install an addition circuit to monitor the output status.
  
- ▶ **Never connect the overload than rated to the output module nor allow the output circuit to have a short circuit,** which may cause a fire.
  
- ▶ **Never let the external power of the output circuit be designed to be On earlier than PLC power,** which may cause abnormal output or operation.
  
- ▶ **In case of data exchange between computer or other external equipment and PLC through communication or any operation of PLC (e.g. operation mode change), please install interlock in the sequence program to protect the system from any error.** If not, it may cause abnormal output or operation.

# Safety Instruction

## Safety Instructions when designing

### **Caution**

- ▶ **I/O signal or communication line shall be wired at least 100mm away from a high-voltage cable or power line.** If not, it may cause abnormal output or operation.

## Safety Instructions when designing

### **Caution**

- ▶ **Use PLC only in the environment specified in PLC manual or general standard of data sheet.** If not, electric shock, fire, abnormal operation of the product or flames may be caused.
- ▶ **Before installing the module, be sure PLC power is off.** If not, electric shock or damage on the product may be caused.
- ▶ **Be sure that each module of PLC is correctly secured.** If the product is installed loosely or incorrectly, abnormal operation, error or dropping may be caused.
- ▶ **Be sure that I/O or extension connector is correctly secured.** If not, electric shock, fire or abnormal operation may be caused.
- ▶ **If lots of vibration is expected in the installation environment, don't let PLC directly vibrated.** Electric shock, fire or abnormal operation may be caused.
- ▶ **Don't let any metallic foreign materials inside the product,** which may cause electric shock, fire or abnormal operation..

# Safety Instruction

## Safety Instructions when wiring

### **Warning**

- ▶ **Prior to wiring, be sure that power of PLC and external power is turned off.** If not, electric shock or damage on the product may be caused.
- ▶ **Before PLC system is powered on, be sure that all the covers of the terminal are securely closed.** If not, electric shock may be caused

### **Caution**

- ▶ **Let the wiring installed correctly after checking the voltage rated of each product and the arrangement of terminals.** If not, fire, electric shock or abnormal operation may be caused.
- ▶ **Secure the screws of terminals tightly with specified torque when wiring.** If the screws of terminals get loose, short circuit, fire or abnormal operation may be caused.
- \*
  - ▶ **Surely use the ground wire of Class 3 for PE terminals, which is exclusively used for PLC.** If the terminals not grounded correctly, abnormal operation may be caused.
  - ▶ **Don't let any foreign materials such as wiring waste inside the module while wiring,** which may cause fire, damage on the product or abnormal operation.

# Safety Instruction

## Safety Instructions for test-operation or repair

### **Warning**

- ▶ **Don't touch the terminal when powered.** Electric shock or abnormal operation may occur.
- ▶ **Prior to cleaning or tightening the terminal screws, let all the external power off including PLC power.** If not, electric shock or abnormal operation may occur.
- ▶ **Don't let the battery recharged, disassembled, heated, short or soldered.** Heat, explosion or ignition may cause injuries or fire.

### **Caution**

- ▶ **Don't remove PCB from the module case nor remodel the module.** Fire, electric shock or abnormal operation may occur.
- ▶ **Prior to installing or disassembling the module, let all the external power off including PLC power.** If not, electric shock or abnormal operation may occur.
- ▶ **Keep any wireless installations or cell phone at least 30cm away from PLC.** If not, abnormal operation may be caused.

## Safety Instructions for waste disposal

### **Caution**

- ▶ **Product or battery waste shall be processed as industrial waste.** The waste may discharge toxic materials or explode itself.

# © Contents ©

## **CHAPTER 1 Introduction 1-1~1-5**

1.1 Overview.....	1-1
1.2 Characteristics .....	1-2
1.3 Terminology .....	1-4

## **CHAPTER 2 System Configuration 2-1~2-15**

2.1 XGT Series System Configuration.....	2-1
2.2 List of Configuration Products .....	2-2
2.3 Basic System .....	2-8
2.3.1 Configuration method of basic system .....	2-8
2.3.2 Max. configuration of basic system (Point fixed) .....	2-9
2.3.3 Max. configuration of basic system (Point variable) .....	2-10
2.3.4 Terminator connections .....	2-11
2.3.5 Module selection when configuring basic system .....	2-12
2.4 Network System.....	2-14
2.4.1 Network systems .....	2-14
2.4.2 OS Version of Communication module .....	2-14
2.4.3 Remote I/O system .....	2-15

## **CHAPTER 3 General Specifications 3-1**

3.1 General Specifications .....	3-1
----------------------------------	-----

## **CHAPTER 4 CPU Module 4-1~4-7**

4.1 Technical Specifications .....	4-1
4.2 Part Names and Functions.....	4-3
4.3 Battery .....	4-6
4.3.1 Battery specifications.....	4-6

4.3.2 Notice in using .....	4-6
4.3.3 Battery durability .....	4-6
4.3.4 Changing the battery .....	4-7

<b>CHAPTER 5 Program Configuration and Operation Method .....</b>	<b>5-1~5-25</b>
---	-----------------

5.1 Program Introduction .....	5-1
5.1.1 Program execution methods .....	5-1
5.1.2 Operation processing during momentary power failure .....	5-2
5.1.3 Scan Time .....	5-3
5.2 Program Execution .....	5-5
5.2.1 Program configuration .....	5-5
5.2.2 Program execution method .....	5-5
5.2.3 Interrupt .....	5-7
5.3 Operation Mode .....	5-13
5.3.1 RUN mode .....	5-13
5.3.2 STOP mode .....	5-14
5.3.3 DEBUG mode .....	5-14
5.3.4 Changing operation mode .....	5-15
5.4 Memory .....	5-16
5.4.1 Program memory .....	5-16
5.4.2 Data memory .....	5-17
5.5 Configuration Diagram of Data Memory .....	5-19
5.5.1 XGK-CPUE .....	5-19
5.5.2 XGK-CPUS .....	5-20
5.5.3 XGK-CPUA .....	5-21
5.5.4 XGK-CPUH .....	5-22
5.5.5 XGK-CPUU .....	5-23
5.5.5 Data Latch Area settings .....	5-24

<b>CHAPTER 6 Functions of CPU Module .....</b>	<b>6-1~6-17</b>
--	-----------------

6.1 Self-Diagnosis .....	6-1
6.1.1 Scan Watchdog Timer .....	6-1
6.1.2 I/O Module Check function .....	6-2



6.1.3 Battery Voltage Check function .....	6-2
6.1.4 Error History Save .....	6-2
6.1.5 Troubleshooting .....	6-2
6.2 Clock.....	6-4
6.3 Remote Function.....	6-6
6.4 Forced I/O On/Off Function .....	6-7
6.4.1 Forced I/O setup method .....	6-7
6.4.2 Forced On/Off execution point and execution method.....	6-8
6.5 Direct I/O Operation .....	6-8
6.6 Saving Operation History .....	6-9
6.6.1 Error history .....	6-9
6.6.2 Mode conversion history .....	6-9
6.6.3 Power shutdown history .....	6-9
6.6.4 System history .....	6-9
6.7 External Device Error Diagnosis.. .....	6-11
6.8 Error Mask .....	6-13
6.9 I/O Module Skip .....	6-14
6.10 Changing Module during Operation.....	6-15
6.11 I/O No. Allocation Method.....	6-16
6.11.1 Fixed I/O no. allocation .....	6-16
6.11.2 Variable I/O no. allocation.....	6-16
6.11.3 Module reservation function.....	6-17
6.12 Program Modification during Operation .....	6-17

<b>CHAPTER 7 I/O Module.....</b>	<b>7-1~7-40</b>
----------------------------------	-----------------

7.1 Notice in selecting module .....	7-1
7.2 Digital Input Module Specifications.....	7-3
7.2.1 8 point DC24V Input module (Source/Sink Type) .....	7-3
7.2.2 16 point DC24V Input module (Source/Sink Type) .....	7-4
7.2.3 16 point DC24V Input module (Source Type) .....	7-5
7.2.4 32 point DC24V Input module (Source/Sink Type) .....	7-6
7.2.5 32 point DC24V Input module (Source type) .....	7-7
7.2.6 64 point DC24V Input module (Source/Sink Type) .....	7-8
7.2.7 64 point DC24V Input module (Source Type) .....	7-9
7.2.8 16 point AC110V Input module.....	7-10

7.2.9 8 point AC220V Input module .....	7-11
7.2.10 8 point AC220V isolated Input module .....	7-12
<b>7.3 Digital Output Module Specifications .....</b>	<b>7-13</b>
7.3.1 8 point Relay Output module.....	7-13
7.3.2 16 point Relay Output module.....	7-14
7.3.3 16 point Relay Output module (Surge Absorber built-in Type) .....	7-15
7.3.4 16 point Triac Output module .....	7-16
7.3.5 16 point Transistor Output module(Sink Type).....	7-17
7.3.6 32 point Transistor Output module(Sink Type).....	7-18
7.3.7 64 point Transistor Output module(Sink Type).....	7-19
7.3.8 16 point Transistor Output module(Source Type) .....	7-20
7.3.9 32 point Transistor Output module(Source Type) .....	7-21
7.3.10 64 point Transistor Output module(Source Type) .....	7-22
7.3.11 8 point Transistor isolated Output module.....	7-23
<b>7.4 Digital IO Module .....</b>	<b>7-24</b>
7.4.1 32 point I/O Combination module.....	7-24
<b>7.5 Event Input Module .....</b>	<b>7-25</b>
7.5.1 Event Input Module .....	7-25
<b>7.6 Smart Link.....</b>	<b>7-26</b>
7.6.1 Modules accessible to Smart Link.....	7-26
7.6.2 Smart Link Components.....	7-26
7.6.3 Smart Link Mapping Table.....	7-27
7.6.4 Smart Link Connection .....	7-27
7.6.5 Smart Link Connection Diagram .....	7-28
7.6.6 Smart Link Specifications & Dimensions.....	7-38

<b>CHAPTER 8 Power Module.....</b>	<b>8-1~8-5</b>
------------------------------------	----------------

8.1 Selection Method .....	8-1
8.2 Specifications.....	8-3
8.3 Part Names.....	8-4
8.4 Current Consumption/Power Calculation Example.....	8-5

**CHAPTER 9 Base and Extended Cable .....9-1~9-2**

9.1 Specifications.....9-1

- 9.1.1 Main base..... 9-1
- 9.1.2 Extended base ..... 9-1
- 9.1.3 Extended cable..... 9-1

9.2 Part Names.....9-2

- 9.2.1 Main base..... 9-2
- 9.2.2 Expansion base..... 9-2

**CHAPTER 10 Built-in PID Functions .....10-1~10-35**

10.1 Features .....10-1

10.2 PID Control .....10-1

10.3 PID Control Operation .....10-2

- 10.3.1 Terms ..... 10-2
- 10.3.2 PID Expressions ..... 10-2
- 10.3.3 P Control ..... 10-3
- 10.3.4 PI Control ..... 10-4
- 10.3.5 PID Control ..... 10-5

10.4 PID Instructions .....10-6

- 10.4.1 PID Loop States ..... 10-6
- 10.4.2 PID Instruction Group ..... 10-7

10.5 PID Flag Configuration .....10-9

- 10.5.1 Common Bit Area .....10-11
- 10.5.2 Individual Data Area ..... 10-14

10.6 Convenient Additional Functions of PID Instructions .....10-21

- 10.6.1 Various PID-based control methods ..... 10-21
- 10.6.2 Operation and function of anti wind-up ..... 10-21
- 10.6.3 Operation and function of Auto-tuning (AT) ..... 10-21
- 10.6.2 Operation and function of cascade (CAS) ..... 10-21

10.7 How to Use PID Instructions .....10-22

- 10.7.1 Hardware Configuration ..... 10-22
- 10.7.2 Program example 1 ..... 10-21

10.7.3 PID controlling .....	10-26
10.7.4 How to start up using AT (Auto-tuning) .....	10-32
10.7.5 Program example 2 .....	10-33
10.7.6 Startup using PWM .....	10-34
10.7.7 Cascade startup .....	10-35

<b>CHAPTER 11 Installation and Wiring .....</b>	<b>11-1~11-12</b>
---	-------------------

11.1 Installation .....	11-1
11.1.1 Installation environment.....	11-1
11.1.2 Handling precautions.....	11-4
11.1.3 Attachment/Detachment of module .....	11-7
11.2 Wiring.....	11-9
11.2.1 Power wiring .....	11-9
11.2.2 I/O Device wiring .....	11-11
11.2.3 Ground wiring .....	11-11
11.2.4 Cable specifications for wiring.....	11-12

<b>CHAPTER 12 Maintenance and Repair .....</b>	<b>12-1~12-2</b>
--	------------------

12.1 Repair and Checking.....	12-1
12.2 Daily Checking .....	12-1
12.3 Regular Checking .....	12-2

<b>CHAPTER 13 EMC Directive .....</b>	<b>13-1~13-4</b>
---------------------------------------	------------------

13.1 Requirements for Conformance to EMC Directive .....	13-1
13.1.1 EMC Standard .....	13-1
13.1.2 Control Panel.....	13-2
13.1.3 Cables .....	13-3
13.2 Requirement to Conform to the Low-voltage Directive .....	13-4
13.1.1 Standard Applied for MasterLogic-200 Series.....	13-4
13.1.2 XGT Series PLC Selection .....	13-4

**CHAPTER 14 Troubleshooting ..... 14-1~14-16**

14.1 Basic Procedure for Troubleshooting ..... 14-1

14.2 Troubleshooting ..... 14-1

    14.2.1 Action when Power LED is OFF ..... 14-2

    14.2.2 Action when ERR LED is blinking ..... 14-3

    14.2.3 Action when RUN, STIOP LED is OFF ..... 14-4

    14.2.4 Action when I/O Module does not work normally ..... 14-5

    14.2.5 Action when Program Write does not work normally ..... 14-7

14.3 Questionnaire for Troubleshooting ..... 14-8

14.4 Cases ..... 14-9

    14.4.1 Input circuit error types and corrective actions ..... 14-9

    14.4.2 Output circuit error types and corrective actions..... 14-10

14.5 Error Code List..... 14-12

    14.5.1 Error code during CPU operation..... 14-12

    14.5.2 Error code of program operation ..... 14-15

**Appendix 1 Flag List ..... App.1-1~App.1-14**

App.1.1 Special Relay (F) List..... App.1-1

App.1.2 Communication Relay (L) List..... App.1-10

App.1.3 Link Register (N) List ..... App.1-13

**Appendix 2 Dimensions..... App.2-1~App.2-3**

**Appendix 3 Compatibility with MASTER-K ..... App.3-1~App.3-5**

**Warranty**

# Revision History

Version	Date	Contents	Chapter
V 1.0	2006.2	First Edition	-
V1.1	2009.10	<ol style="list-style-type: none"> <li>1. XGK-CPUU added</li> <li>2. Fnet -&gt; Rnet modified</li> <li>3. Scan Time modified</li> <li>4. Interrupt module removed</li> <li>5. Clock data F device modified</li> <li>6. Heavy error/light error modified</li> <li>7. Fault mask -&gt; "Release by program" removed</li> <li>8. Skip function -&gt; "Release by program" removed</li> <li>9. Product list modified</li> <li>10. Program language SFC, ST added</li> <li>11. XGQ-SOEA added</li> <li>12. Flag list modified</li> </ol>	<p>Ch1.1, Ch2.3.1, Ch2.4.1, Ch4.1</p> <p>Ch1.3</p> <p>Ch5.1.3</p> <p>Ch7.1</p> <p>Ch6.2</p> <p>Ch6.7</p> <p>Ch6.8</p> <p>Ch6.9</p> <p>Ch2.2</p> <p>Ch4.1</p> <p>Ch7.5</p> <p>Appendix 1</p>
V1.6	2010.3	<ol style="list-style-type: none"> <li>1. Product list modified</li> <li>2. Supported functions according to OS version</li> <li>3. Description on Reset/D.Clear switch added</li> <li>4. Wiring diagram of Smart Link added</li> <li>5. Flag added (indicated version to decimal places <code>_OS_VER_PATCH</code>)</li> <li>6. Typos fixed</li> </ol>	<p>Ch2.2, Ch2.4.2</p> <p>Ch4.1</p> <p>Ch4.2</p> <p>Ch7.6.3</p> <p>App1.1</p> <p>Ch1.1, Ch1.2, Ch1.3</p> <p>Ch3.1, Ch4.1</p> <p>Ch5.2.3, Ch5.5</p> <p>Ch8.1</p> <p>Ch10.3, Ch10.7</p> <p>CH12.2, 12.3</p>
V1.7	2013.1	<ol style="list-style-type: none"> <li>1. Product list modified</li> <li>2. Size of data refresh area added</li> <li>3. Supported functions according to CPU OS version added</li> <li>4. Fixed cycle task's flag information added</li> <li>5. Digital I/O module added XGI-A21C, XGQ-TR1C</li> <li>6. Flag added</li> </ol>	<p>Ch2.2</p> <p>Ch2.3.5</p> <p>Ch4.1</p> <p>Ch5.2.3</p> <p>Ch7.2.10</p> <p>Ch7.3.11</p> <p>App1.1</p>

Version	Date	Contents	Chapter
V 1.8	2015. 2	1.CPU Module Added (XGK-CPUUN, XGK-CPUHN, XGK-CPUSN)	1.2, 2.2, 2.3, 2.4, 4.1, 4.2, 5.1.3, 5.4.1, 5.4.2 5.5, 6.13, 8.1, Appendix1.1
V 1.9	2015. 9	1. Circuit configuration modified 2. Smart Link Model name modified 3. Rated input voltage modified 4. Terminology modified (FG → PE) 5. CPU Processing Speed Unit changed (us → ns) 6. List of Configuration Products updated	7.2, 7.3, 7.4, 7.5 7.6 8.2 8.3, 9.1, 9.2, 11.2, 13.1 1.2, 4.1 2.2
V 2.0	2016. 3	1. Smart Link manual supplemented	7.6

## About User's Manual

---

### About User's Manual

Thank you for purchasing PLC of LS Industrial System Co., Ltd.

Before use, make sure to carefully read and understand the User's Manual about the functions, performances, installation and programming of the product you purchased in order for correct use and importantly, let the end user and maintenance administrator to be provided with the User's Manual.

The User's Manual describes the product. If necessary, you may refer to the following description and order accordingly. In addition, you may connect our website(<http://www.lsis.com/>) and download the information as a PDF file.

#### Relevant User's Manuals

Title	Description	No. of User's Manual
XGK / XGB Instructions & Programming	It is the user's manual for programming to explain how to use commands that are used PLC system with XGK CPU and XGB CPU.	10310000510
XG5000	It describes how to use XG5000 software especially about online functions such as programming, printing, monitoring and debugging by using XGT series products.	10310000512



# Chapter 1 Introduction

## 1.1 Overview

This User's Manual provides the information for the specification, performance and operation method of each product required to use a PLC system configured by XGK series CPU modules.

The configuration of User's Manual is as follows :

Chapter	Items	Description
Chapter 1	Overview	Describes the configuration of this user's manual, product characteristics and terminology.
Chapter 2	System Configuration	Describes the product type and system configuration method to be used for XGK series.
Chapter 3	General Specifications	Shows the common specification of each module used for XGK series.
Chapter 4	CPU Module	Describes the performance, specification and operation method of XGK-CPU
Chapter 5	Program Configuration and Operation Method	
Chapter 6	Function of CPU Module	
Chapter 7	I/O Module	Describes the specification and the method to use I/O module and power module except CPU module.
Chapter 8	Power Module	
Chapter 9	Base and Extended Cable	
Chapter 10	Built-in PID	Describes on the built-in PID function
Chapter 11	Installation and Wiring	Describes the installation, wiring method and notices to secure the reliability of PLC system.
Chapter 12	Maintenance & Repair	Describes the checking items and methods to run the PLC system normally for a long time.
Chapter 13	EMC Directive	Summarizes the precautions on conformance to the EMC Directive of the machinery assembled using XGK series.
Chapter 14	Trouble Shooting	Describes various errors and action methods occurred while using a system.
Appendix 1	Flag List	Describes various type of each flag and its description.
Appendix 2	Dimensions	Shows the outer dimension of CPU, I/O module and Base.
Appendix 3	Compatibility with MASTER-K	

### Notes

- 1) This user's manual does not describe the special/communication module and program writing method. For the corresponding function, please refer to the related user's manual.
- 2) XGK CPU is one of the XGT PLC system and CPU types of XGT PLC system are as follows.
  - ① XGK series: XGT PLC system that consists of CPU using Master-K
  - ② XGI series: XGT PLC system that consists of single CPU using IEC language
  - ③ XGR series: XGT PLC system that consists of redundancy CPU using IEC language

### 1.2 Characteristics

XGK system has the features as below.

#### 1) Compact size

The function is extended to large sized but the size is reduced innovatively to make the installation in the small space for any purpose easily.

#### 2) High speed processing

##### (1) XGK-CPUUN

- Sequence command: 8.5 ns
- MOV command: 25.5 ns
- Floating point arithmetic operation(the operation for the single real number and double real number accuracy is profoundly improved)

Classification	+	-	×	÷
Single Real	183 ns	183 ns	336 ns	345 ns
Double Real	327 ns	327 ns	727 ns	808 ns

##### (2) XGK-CPUU

- Sequence command: 28 ns
- MOV command: 84 ns
- Floating point arithmetic operation

Classification	+	-	×	÷
Single Real	602 ns	602 ns	1,106 ns	1,134 ns
Double Real	1,078 ns	1,078 ns	2,394 ns	2,660 ns

##### (3) Improvement of data transfer speed between modules through base.

- 16 point I/O module data process: 200 ns ~ 800 ns
- Analogue 1 Ch data process: 200 ns ~ 800 ns
- 1 KB communication module data process: 12,800 ns
- Parallel process by I/O data auto refresh during programming

#### 3) Convenience to use Analog Data

Analog module enforced the precision and stability and provides the convenience as below :

- Program simplification by providing analog data dedicated 'U' device
- Setting without memory map of special module is available by providing parameter setting method.

#### 4) System Configuration

Various convenient functions are provided to meet the demands of users.

- Filter value adjustment of input module
- Output hold at emergency time
- Varistor built-in relay output module with strong durability
- Total extension length of expanded base shall be 15m.
- Provides system RUN contact to power module.
- Cost efficiency of setup, startup and maintenance/repair by enforced self-diagnosis function

### 5) Various communication system

Provides various network function to satisfy both the user convenience and compatibility.

- Network opening available without writing a ladder program
- Network setting and operation status monitoring by dedicated tool(XG-PD)
- Supports Open network of various international specification
- Dedicated network to provide the ease in use and optimal performance
- Network compatibility with the existing products (MASTER-K, GLOFA-GM)

### 6) Enforcement of program and online function

Minimized the program writing time by providing the convenience of programming and available to complete the control system of equipment without stopping the system by enforcement of online function.

- Compatibility of ladder and text (Mnemonic) method
- Enforcement of symbolic program
- Automatic conversion of MASTER-K program
- Available to modify the program during operation and secure the stability
- Available to install and change the network during operation
- Enforcement of trend monitoring function
- User event function
- Data trace function

### 7) User's convenience

Various functions are provided for user's convenience.

- Module Changing Wizard (User's tool is unnecessary.)
- System Diagnosis
- Skip I/O
- Fault Mask
- I/O Allocation Method
- Various Operation History

## Chapter 1 Introduction

### 1.3 Terminology

Here describes the terminology used in this user's manual.

Terminology	Definition	Remarks
Module	A device like I/O board assembled to insert in a motherboard or base as a standardized factor having the regular function to configure the system.	Ex) CPU module, power module, I/O module etc.
Unit	A module or module aggregate which is the minimum unit in operation of PLC system. It configures the PLC system by connecting to other module or module aggregate.	Ex) Basic unit, Extended unit
PLC System	A system consisted of PLC and peripherals and which is configured to enable the control by user program	
XG 5000	Graphic loader to carry out program writing, editing and debug function	
I/O image area	Internal memory area of CPU module installed to maintain the input and output state	
Rnet	Remote Network (Remote dedicated network)	
Fnet	Field bus Network	
RAPIEnet	Real-time Automation Protocols for Industrial Ethernet	
Cnet	Computer Network	
FEnet	Fast Ethernet Network	
Pnet	Profibus-DP Network	
Dnet	DeviceNet Network	
RTC	Real Time Clock. A general name of universal IC having the clock function	
Watchdog Timer	A timer to monitor the assigned running time of program and give an alarm if failed to complete the processing within the assigned time.	
Task	There are three kind of tasks. (cycle time task, internal device task, external device task by external interrupt module's input signal)	

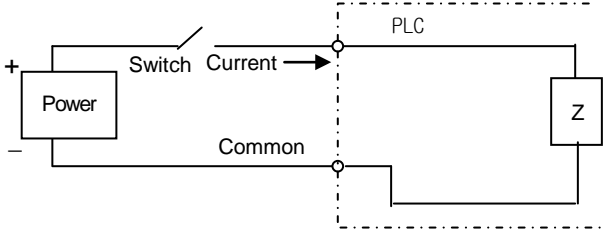
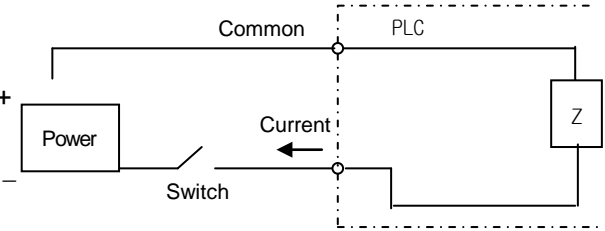
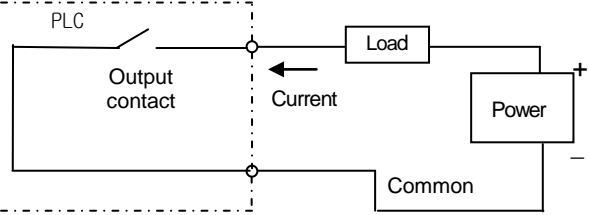
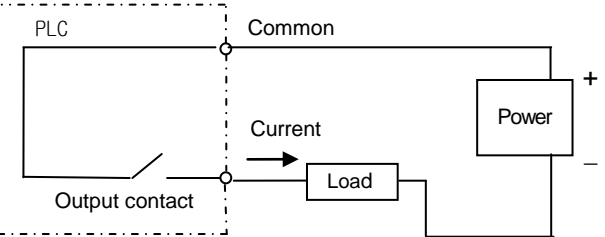
Terminology	Definition	Remarks
Sink input	<p>The mode that the current flows from the switch to PLC input terminal when input signal is ON.</p> 	Z : Input resistance
Source input	<p>The mode that the current flows from PLC input terminal to the switch when input signal is ON.</p> 	
Sink output	<p>The mode that the current flows from load to output terminal when PLC output contact is ON.</p> 	
Source output	<p>The mode that the current flows from output contact when PLC output contact is ON.</p> 	

## Chapter 2 System Configuration

XGT series are equipped with various products proper for basic system, computer link and network system configuration. Here describes the configuration method of each system and its features.

### 2.1 XGT Series System Configuration

XGT series system configuration is as below:

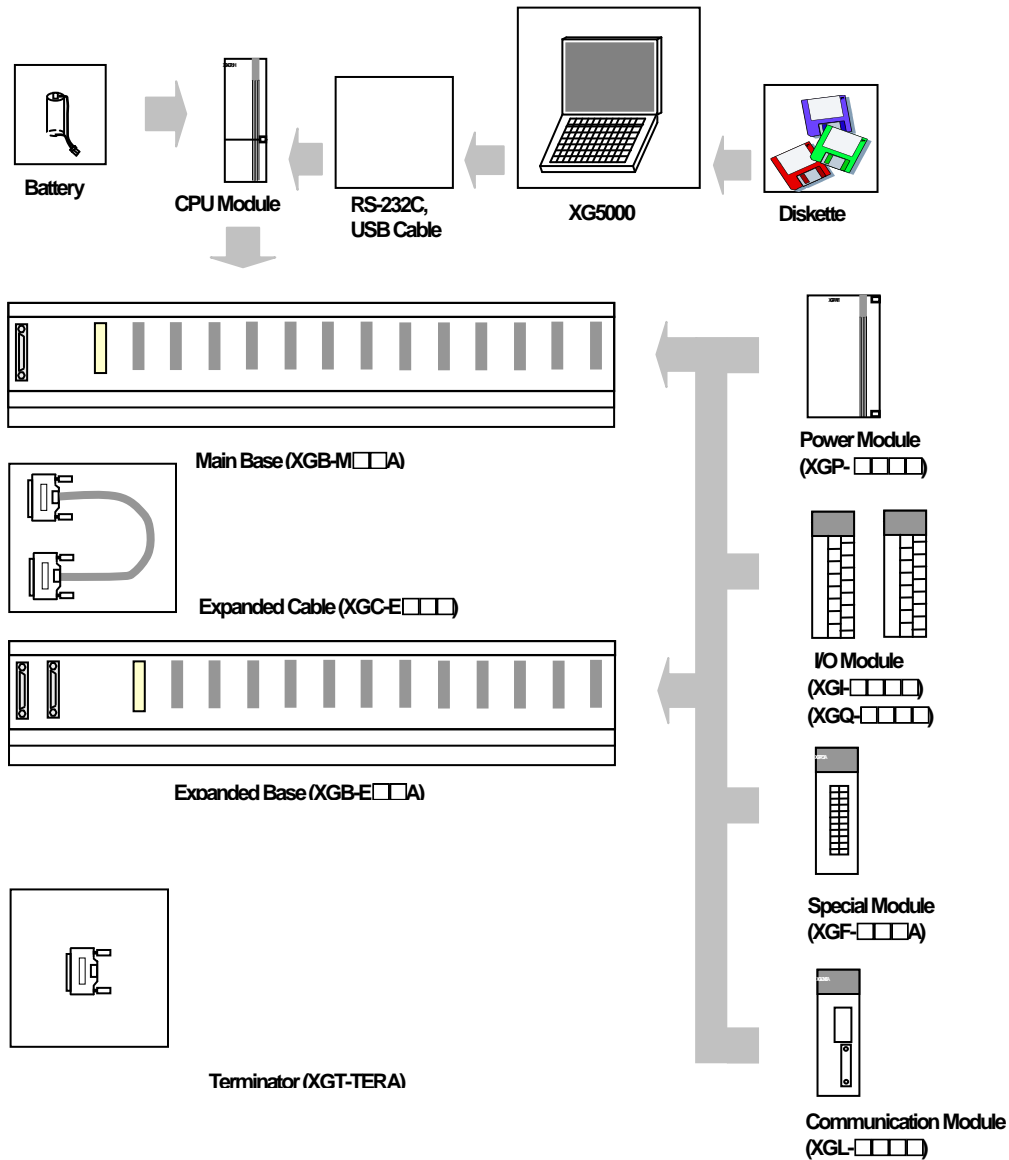

Recommendations of selecting USB Cable (To avoid disconnection with XG5000)

1. Recommend that the company's USB Cable(USB-301A) which is shielded and shorter than 3m.
2. Recommend using USB Hub when connecting up to the PC poor at Noise.

## Chapter 2 System Configuration

### 2.2 Configuration Products

The product configuration of XGK series is as below :

Product	Model	Description	Remarks
CPU Module	XGK-CPUE	• Standard type CPU module (Max I/O point: 1,536 points)	16kstep
	XGK-CPUS	• Standard type CPU module (Max I/O point: 3,072 points)	32kstep
	XGK-CPUA	• High speed type CPU module (Max. I/O point: 3,072 points)	32kstep
	XGK-CPUH	• High speed type CPU module (Max. I/O point: 6,144 points)	64kstep
	XGK-CPUU	• High speed type CPU module (Max. I/O point: 6,144 points)	128kstep
	XGK-CPUSN	• High speed type CPU module (Max. I/O point: 3,072 points)	64kstep
	XGK-CPUHN	• High speed type CPU module (Max. I/O point: 6,144 points)	128kstep
	XGK-CPUUN	• High speed type CPU module (Max. I/O point: 6,144 points)	256kstep
Digital Input Module	XGI-D21A	• DC 24V Input, 8 point (Current source / sink input)	-
	XGI-D21D	• DC 24V Diagnostic Input, 8 point (Current sink input)	-
	XGI-D22A	• DC 24V Input, 16 point (Current source / sink input)	-
	XGI-D24A	• DC 24V Input, 32 point (Current source / sink input)	-
	XGI-D28A	• DC 24V Input, 64 point (Current source / sink input)	-
	XGI-D22B	• DC 24V Input, 16 point (Current source input)	-
	XGI-D24B	• DC 24V Input, 32 point (Current source input)	-
	XGI-D28B	• DC 24V Input, 64 point (Current source input)	-
	XGI-A12A	• AC 110V input, 16 point	-
	XGI-A21A	• AC 220V input, 8 point	-
	XGI-A21C	• AC 220V isolated input, 8 points	-
Digital Output Module	XGQ-RY1A	• Relay output, 8 point (for 2A, single COM.)	-
	XGQ-RY1D	• Diagnostic Relay output, 8 point (for 2A, single COM.)	-
	XGQ-RY2A	• Relay output, 16 point (for 2A)	-
	XGQ-RY2B	• Relay output, 16 point (for 2A), Varistor attached	-
	XGQ-TR2A	• Transistor output, 16 point (for 0.5A, Sink output)	-
	XGQ-TR4A	• Transistor output, 32 point (for 0.1A, Sink output)	-
	XGQ-TR8A	• Transistor output, 64 point (for 0.1A, Sink output)	-
	XGQ-TR2B	• Transistor output 16 point (for 0.5A, Source output)	-
	XGQ-TR4B	• Transistor output 32 point (for 0.1A, Source output)	-
	XGQ-TR8B	• Transistor output 64 point (for 0.1A, Source output)	-
	XGQ-SS2A	• Triac output, 16 point (for 0.6A)	-
	XGQ-TR1C	• Transistor isolated output, 8 points (2A)	-
Digital I/O Module	XGH-DT4A	• DC 24V input, 16 point (current source / sink input) • Transistor output, 16 point (for 0.1A, Sink output)	-

Product	Model	Description	Remarks	
Main Base	XGB-M04A	• for 4 module installation	-	
	XGB-M06A	• for 6 module installation	-	
	XGB-M08A	• for 8 module installation	-	
	XGB-M12A	• for 12 module installation	-	
Expanded Base	XGB-E04A	• for 4 module installation	-	
	XGB-E06A	• for 6 module installation	-	
	XGB-E08A	• for 8 module installation	-	
	XGB-E12A	• for 12 module installation	-	
Power module	XGP-ACF1	AC100V~240V input	• DC5V: 3A, • DC24V: 0.6A	-
	XGP-ACF2	AC100V~240V input	• DC5V: 6A	-
	XGP-AC23	AC100V~240V input	• DC5V: 8.5A	-
	XGP-DC42	DC24V Input	• DC5V: 6A	-
Extended cable	XGC-E041	• Length : 0.4 m	Total extension distance should not exceed 15m	
	XGC-E061	• Length : 0.6 m		
	XGC-E121	• Length : 1.2 m		
	XGC-E301	• Length : 3.0 m		
	XGC-E501	• Length : 5.0 m		
	XGC-E102	• Length : 10 m		
	XGC-E152	• Length : 15 m		
Terminator	XGT-TERA	• Must use for base expansion	-	
Dust-proof Module	XGT-DMMA	• Dust protection module for not-used slot	-	
Battery	XGT-BAT	• Battery for XGT (DC 3.0V / 1,800 mAh)	-	



## Chapter 2 System Configuration

Product	Model	Description	Remarks
Analog input Module	XGF-AV8A	<ul style="list-style-type: none"> <li>• Voltage Input: 8 channel</li> <li>• DC 1 ~ 5V / 0 ~ 5V / 0 ~ 10V / -10 ~ +10V</li> </ul>	-
	XGF-AC8A	<ul style="list-style-type: none"> <li>• Current Input: 8 channel</li> <li>• DC 4 ~ 20mA / 0 ~ 20mA</li> </ul>	-
	XGF-AD08A	<ul style="list-style-type: none"> <li>• Voltage/Current Input: 8 channels</li> </ul>	-
	XGF-AD4S	<ul style="list-style-type: none"> <li>• Voltage/Current Input: 4 channels</li> <li>• Insulation between channels</li> </ul>	-
	XGF-AD16A	<ul style="list-style-type: none"> <li>• Voltage/Current Input: 16 channels</li> </ul>	-
	XGF-AW4S	<ul style="list-style-type: none"> <li>• 2-wire voltage/current input: 4 –channel, insulation between channels</li> <li>• 2-wire transmitter driver power supported</li> </ul>	-
Analog output Module	XGF-DV4A	<ul style="list-style-type: none"> <li>• Voltage Output: 4 channels</li> <li>• DC 1 ~ 5V / 0 ~ 5V / 0 ~ 10V / -10 ~ +10V</li> </ul>	-
	XGF-DC4A	<ul style="list-style-type: none"> <li>• Current Output: 4 channels</li> <li>• DC 4 ~ 20mA / 0 ~ 20mA</li> </ul>	-
	XGF-DV4S	<ul style="list-style-type: none"> <li>• Current Output: 4 channels</li> <li>• Insulation between channels</li> </ul>	-
	XGF-DC4S	<ul style="list-style-type: none"> <li>• Current Output: 4 channels</li> <li>• Insulation between channels</li> </ul>	-
	XGF-DV8A	<ul style="list-style-type: none"> <li>• Voltage Output: 8 channels</li> <li>• DC 1 ~ 5V / 0 ~ 5V / 0 ~ 10V / -10 ~ +10V</li> </ul>	-
	XGF-DC8A	<ul style="list-style-type: none"> <li>• Current Output: 8 channels</li> <li>• DC 4 ~ 20mA / 0 ~ 20mA</li> </ul>	-
Analog I/O Module	XGF-AH6A	<ul style="list-style-type: none"> <li>• Voltage/Current input 4 channels</li> <li>• Voltage/Current output 2 channels</li> </ul>	-
HART I/F Analog Input Module	XGF-AC4H	<ul style="list-style-type: none"> <li>• Current Input : 4 channel</li> <li>• HART I/F, DC 4 ~ 20mA</li> </ul>	-
HART I/F Analog Output Module	XGF-DC4H	<ul style="list-style-type: none"> <li>• Current Output : 4 channel</li> <li>• HART I/F, DC 4 ~ 20mA</li> </ul>	-
Thermocouple Input Module	XGF-TC4S	<ul style="list-style-type: none"> <li>• Temperature (T/C) Input, 4 channels,</li> <li>• Insulation between channels</li> </ul>	-
RTD Input Module	XGF-RD4A	<ul style="list-style-type: none"> <li>• Temperature (RTD) Input, 4 channels</li> </ul>	-
	XGF-RD4S	<ul style="list-style-type: none"> <li>• Temperature (RTD) Input, 4 channels</li> <li>• Insulation between channels</li> </ul>	-
	XGF-RD8A	<ul style="list-style-type: none"> <li>• Temperature (RTD) Input, 8 channels</li> </ul>	-
Temp. control Module	XGF-TC4UD	<ul style="list-style-type: none"> <li>• Control loop : 4 loops</li> <li>• Input(4 channels, TC/RTD/voltage/current), Output(8 channels, TR/current)</li> </ul>	-
	XGF-TC4RT	<ul style="list-style-type: none"> <li>• Control loop: 4 loops</li> <li>• input (4 channels, RTD), Output (8 channels, TR)</li> </ul>	-
High speed Counter Module	XGF-HO2A	<ul style="list-style-type: none"> <li>• Voltage Input type (Open Collector type)</li> <li>• 200kHz, 2 channel</li> </ul>	-
	XGF-HD2A	<ul style="list-style-type: none"> <li>• Differential Input type (Line Driver type)</li> <li>• 500kHz, 2 channel</li> </ul>	-
	XGF-HO8A	<ul style="list-style-type: none"> <li>• Voltage Input type (Open Collector type)</li> <li>• 200kHz, 8 channel</li> </ul>	-

Product	Model	Description	Remarks
Positioning Module	XGF-PO3A	• Pulse output (Open Collector type), 3 axes	-
	XGF-PO2A	• Pulse output (Open Collector type), 2 axes	-
	XGF-PO1A	• Pulse output (Open Collector type), 1 axis	-
	XGF-PD3A	• Pulse output (Line Drive type), 3 axes	-
	XGF-PD2A	• Pulse output (Line Drive type), 2 axes	-
	XGF-PD1A	• Pulse output (Line Drive type), 1 axis	-
	XGF-PO4H	• Pulse output (Open Collector type), 4 axes	-
	XGF-PO3H	• Pulse output (Open Collector type), 3 axes	-
	XGF-PO2H	• Pulse output (Open Collector type), 2 axes	-
	XGF-PO1H	• Pulse output (Open Collector type), 1 axes	-
	XGF-PD4H	• Pulse output (Line Drive type), 4 axes	-
	XGF-PD3H	• Pulse output (Line Drive type), 3 axes	-
	XGF-PD2H	• Pulse output (Line Drive type), 2 axes	-
	XGF-PD1H	• Pulse output (Line Drive type), 1 axes	-
	XGF-PN8A	• Network type(EtherCat), 8 axes, LS dedicated type	-
	XGF-PN8B	• Network type(EtherCat), 8 axes, Standard type	-
Motion Control Module	XGF-M16M	• Motion dedicated net (M-II) type, 16 axes	-
	XGF-M32E	• Motion dedicated net (EtherCAT) type, 32 axes	-
Event Input Module	XGF-SOEA	• DC 24V input, 32 point, Sequence of Event module	-
Data Log Module	XGF-DL16A	• USB 2.0, CF2001, Max 16GB • 32 points (Input: 22 points , Output : 10 points)	-

## Chapter 2 System Configuration

Product	Model	Description	Remarks
FEnet Module (Optical/Elec.)	XGL-EFMF	<ul style="list-style-type: none"> <li>• Fast Ethernet(optical), Master</li> <li>• 100/10 Mbps support</li> </ul>	-
	XGL-EFMT	<ul style="list-style-type: none"> <li>• Fast Ethernet(electrical), Master</li> <li>• 100/10 Mbps support</li> </ul>	-
	XGL-ESHF	<ul style="list-style-type: none"> <li>• Fast Ethernet Switch module(optical)</li> </ul>	-
	XGL-EH5T	<ul style="list-style-type: none"> <li>• Fast Ethernet Switch module(electrical)</li> </ul>	-
RAPIEnet	XGL-EIMT	<ul style="list-style-type: none"> <li>• Communication Module between PLCs (electrical)</li> <li>• 100 Mbps Industrial Ethernet supported</li> </ul>	-
	XGL-EIMF	<ul style="list-style-type: none"> <li>• Communication Module between PLCs (optical)</li> <li>• 100 Mbps Industrial Ethernet supported</li> </ul>	-
	XGL-EIMH	<ul style="list-style-type: none"> <li>• Communication Module between PLCs (electrical / optical)</li> <li>• 100 Mbps Industrial Ethernet supported</li> </ul>	-
	XGL-ES4T	<ul style="list-style-type: none"> <li>• Communication Module between PLCs (electrical)</li> <li>• 100 Mbps Industrial Ethernet supported</li> <li>• RAPIEnet Switch</li> </ul>	-
Cnet Module	XGL-C22A	<ul style="list-style-type: none"> <li>• Serial communication</li> <li>• RS-232C, 2 channel</li> </ul>	-
	XGL-C42A	<ul style="list-style-type: none"> <li>• Serial communication</li> <li>• RS-422(485), 2 channel</li> </ul>	
	XGL-CH2A	<ul style="list-style-type: none"> <li>• Serial communication</li> <li>• RS-232C 1 channel / RS-422(485) 1 channel</li> </ul>	
FDEnet Module(Master)	XGL-EDMF	<ul style="list-style-type: none"> <li>• Dedicated Ethernet(optical), Master</li> <li>• Deterministic communication support</li> <li>• 100/10 Mbps support</li> </ul>	-
	XGL-EDMT	<ul style="list-style-type: none"> <li>• Dedicated Ethernet(electrical), Master</li> <li>• Deterministic communication support</li> <li>• 100/10 Mbps support</li> </ul>	
Rnet Module	XGL-RMEA	<ul style="list-style-type: none"> <li>• for Rnet Master I/F (Smart I/O communication available)</li> <li>• Fast response speed support(against the existing Fnet module)</li> <li>• 1 Mbps base band</li> <li>• for twisted cable</li> </ul>	-
Profibus-DP Module	XGL-PMEA XGL-PMEC	<ul style="list-style-type: none"> <li>• Profibus-DP Master module</li> </ul>	-
Pnet Slave I/F module	XGL-PSEA	<ul style="list-style-type: none"> <li>• Profibus-DP Slave module</li> </ul>	-
DeviceNet Module	XGL-DMEA	<ul style="list-style-type: none"> <li>• DeviceNet Master module</li> </ul>	-
Ethernet/IP Module	XGL-EIPT	<ul style="list-style-type: none"> <li>• EtherNet/IP(electric)</li> <li>• 100/10 Mbps support</li> </ul>	-
BACnet/IP I/F Module	XGL-BIPT	<ul style="list-style-type: none"> <li>• BACNet/IP(electric)</li> <li>• 100/10 Mbps support</li> </ul>	-
Fnet I/F module	XGL-FMEA	<ul style="list-style-type: none"> <li>• Field Bus master module</li> </ul>	-
40-point connector	1473381-1	<ul style="list-style-type: none"> <li>• 40-point connector (For I/O, special module)</li> </ul>	-

**Note**

- 1) For the further information about active coupler, optical converter, repeater and block type remote module, which are network devices, refer to the user's manual of network.
- 2) O/S version of communication module applicable to XGK system is as follows.

Name	Module							
	FEnet	FDEnet	Cnet	Rnet	Pnet	Dnet	RAPIEnet	IFOS module
Model	XGL-EFMT XGL-EFMF	XGL-EDMT XGL-EDMF	XGL-C22A XGL-CH2A XGL-C42A	XGL-RMEA	XGL-PMEA	XGL-DMEA	XGL-EIMF XGL-EIMT XGL-EIMH	XGL-ESHF
Applicable version	V2.0 or above	V2.0 or above	V2.1 or above	V1.0 or above	V1.0 or above	V1.0 or above	V1.0 or above	V1.0 or above

### 2.3 Basic System

#### 2.3.1 Configuration method of Basic System

The features of Basic system consisted by connecting the main base and expanded base by a cable are as follows. The number of stages of expanded base is limited according to the CPU type and the allocation method of I/O No. is available to select the **fixed type** and **variable type** according to the setting of basic parameter.

Classification	XGK-CPUE	XGK-CPUS XGK-CPUSN	XGK-CPUA	XGK-CPUH XGK-CPUHN	XGK-CPUU XGK-CPUUN																																																				
Max. expanded stages	1 stage	3 stages	3 stages	7 stages	7 stages																																																				
Max. no. of I/O Module install	24 Module	48 Module	48 Module	96 Module	96 Module																																																				
Max. I/O point	1,536 points	3,072 points	3,072 points	6,144 points	6,144 points																																																				
Max. extended distance	15m																																																								
Allocation of I/O No. (fixed type)	<ul style="list-style-type: none"> <li>Each slot of base is allocated by 60 points regardless module installation and type.</li> <li>For one base, I/O no. of 16 slots is allocated. That is, the start no. of No.1 base becomes P00640. (Refer to 2.3.2)</li> <li>The example of I/O no. of 12 Slot base is as below : <table border="1" style="margin-left: 40px;"> <thead> <tr> <th>SlotNo.</th> <th>0</th> <th>1</th> <th>2</th> <th>3</th> <th>4</th> <th>5</th> <th>6</th> <th>7</th> <th>8</th> <th>9</th> <th>10</th> <th>11</th> </tr> </thead> <tbody> <tr> <td>P</td> <td>I</td> <td>I</td> <td>I</td> <td>I</td> <td>O</td> <td>O</td> <td>O</td> <td>O</td> <td>I</td> <td>O</td> <td>O</td> <td>O</td> </tr> <tr> <td>W</td> <td>1</td> <td>1</td> <td>3</td> <td>6</td> <td>1</td> <td>3</td> <td>3</td> <td>6</td> <td>3</td> <td>1</td> <td>3</td> <td>3</td> </tr> <tr> <td>R</td> <td>6</td> <td>6</td> <td>2</td> <td>4</td> <td>6</td> <td>2</td> <td>2</td> <td>4</td> <td>2</td> <td>6</td> <td>2</td> <td>2</td> </tr> </tbody> </table> <p style="margin-left: 40px;">P0 P40 P80 P120 P160 P200 P240 P280 P320 P360 P400 P440                      ~ ~ ~ ~ ~ ~ ~ ~ ~ ~ ~ ~ ~ ~                      P3F P7F P11F P15F P19F P23F P27F P31F P35F P39F P43F P47F</p> <p style="margin-left: 40px;">I : input, O : output</p></li> </ul>					SlotNo.	0	1	2	3	4	5	6	7	8	9	10	11	P	I	I	I	I	O	O	O	O	I	O	O	O	W	1	1	3	6	1	3	3	6	3	1	3	3	R	6	6	2	4	6	2	2	4	2	6	2	2
SlotNo.	0	1	2	3	4	5	6	7	8	9	10	11																																													
P	I	I	I	I	O	O	O	O	I	O	O	O																																													
W	1	1	3	6	1	3	3	6	3	1	3	3																																													
R	6	6	2	4	6	2	2	4	2	6	2	2																																													
Allocation of I/O no. (variable type)	<ul style="list-style-type: none"> <li>The point is allocated according to the assignment of installation module per slot. <ul style="list-style-type: none"> <li>If assigned installation module by I/O parameter, the assigned point is allocated.</li> <li>The slot not assigned by I/O parameter shall be allocated automatically according to actual installation slot</li> </ul> </li> <li><b>(Note: 8 point module shall be allocated by 16 point.)</b></li> <li><b>- The empty slot not assigned by I/O parameter shall be processed by 16 point.</b></li> <li>Available to assign the point only by I/O parameter without module assignment.</li> <li><b>The slot installed by special module or communication module is allocated by 16 point.</b></li> <li>The example of I/O no. of 12 Slot base is as below : <table border="1" style="margin-left: 40px;"> <thead> <tr> <th>SlotNo.</th> <th>0</th> <th>1</th> <th>2</th> <th>3</th> <th>4</th> <th>5</th> <th>6</th> <th>7</th> <th>8</th> <th>9</th> <th>10</th> <th>11</th> </tr> </thead> <tbody> <tr> <td>P</td> <td>I</td> <td>I</td> <td>I</td> <td>I</td> <td>O</td> <td>O</td> <td>O</td> <td>O</td> <td>I</td> <td>O</td> <td>O</td> <td>O</td> </tr> <tr> <td>W</td> <td>1</td> <td>1</td> <td>3</td> <td>6</td> <td>1</td> <td>3</td> <td>3</td> <td>6</td> <td>3</td> <td>1</td> <td>3</td> <td>3</td> </tr> <tr> <td>R</td> <td>6</td> <td>6</td> <td>2</td> <td>4</td> <td>6</td> <td>2</td> <td>2</td> <td>4</td> <td>2</td> <td>6</td> <td>2</td> <td>2</td> </tr> </tbody> </table> <p style="margin-left: 40px;">P00 P10 P20 P40 P80 P90 P110 P130 P170 P190 P200 P220                      ~ ~ ~ ~ ~ ~ ~ ~ ~ ~ ~ ~ ~ ~                      P0F P1F P3F P7F P8F P10F P12F P16F P18F P19F P21F P23F</p> <p style="margin-left: 40px;">I : input, O : output</p></li> </ul>					SlotNo.	0	1	2	3	4	5	6	7	8	9	10	11	P	I	I	I	I	O	O	O	O	I	O	O	O	W	1	1	3	6	1	3	3	6	3	1	3	3	R	6	6	2	4	6	2	2	4	2	6	2	2
SlotNo.	0	1	2	3	4	5	6	7	8	9	10	11																																													
P	I	I	I	I	O	O	O	O	I	O	O	O																																													
W	1	1	3	6	1	3	3	6	3	1	3	3																																													
R	6	6	2	4	6	2	2	4	2	6	2	2																																													

#### Notes

- 1) The allocation method of I/O no. shall be set in basic parameter.
- 2) For Main base, the base no. is fixed as "0" and the expanded base has a switch to set the base no.
- 3) In case of setting module type by I/O parameter, it starts the operation when the type of actually installed module is matched.

2.3.2 Max. Configuration of Basic System (Point Fixed)

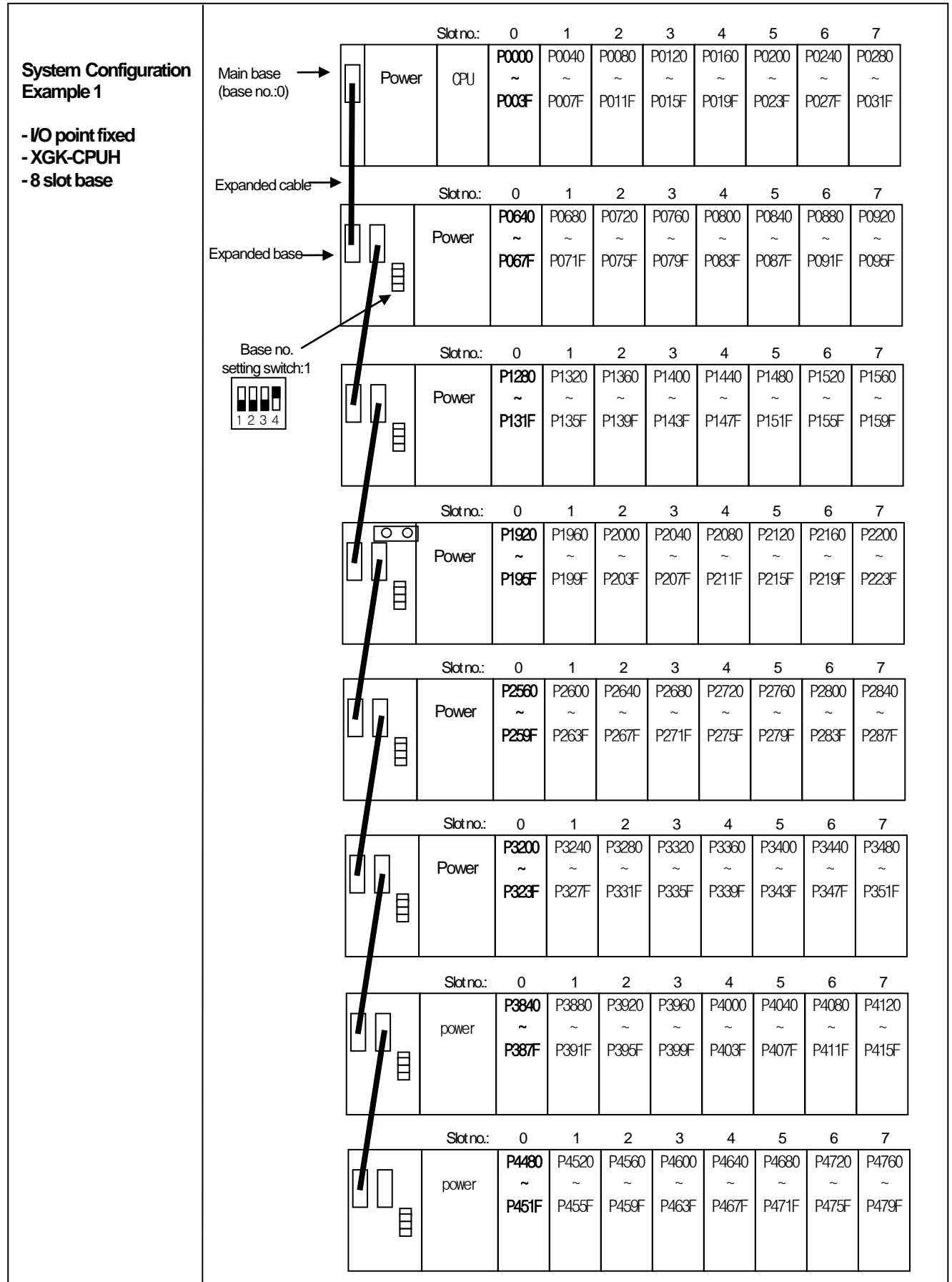

## 2.3.3 Max. Configuration of Basic System (Point variable)

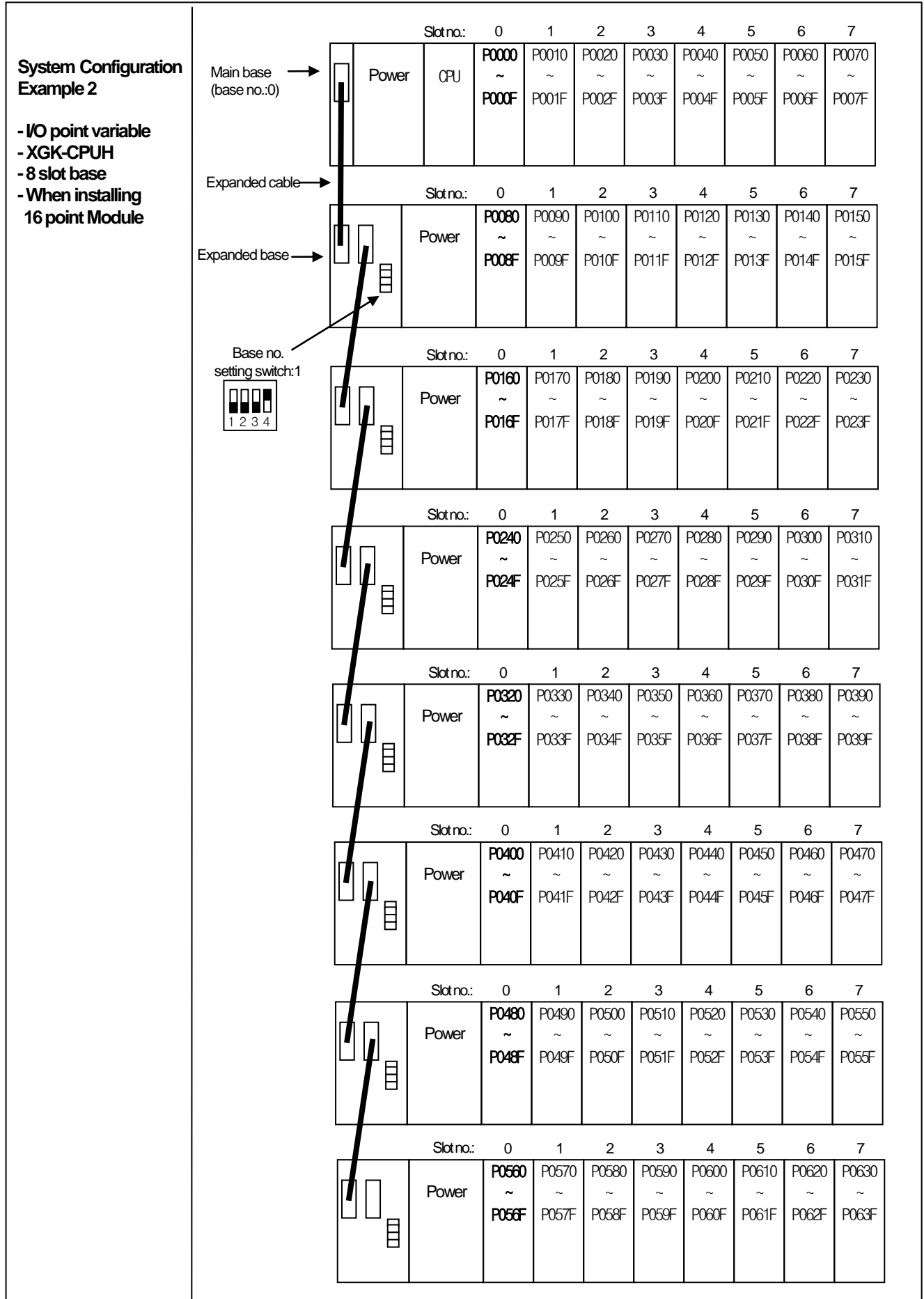

### 2.3.4 Terminator Connections

When an expansion base is connected, a terminator must be installed for the system reliability on the expansion connector (OUT) of the last expansion base.

#### 2.3.4.1 Structure

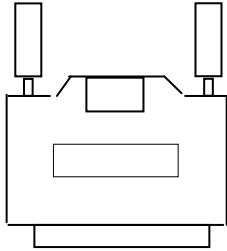

#### 2.3.4.2 Installation Position

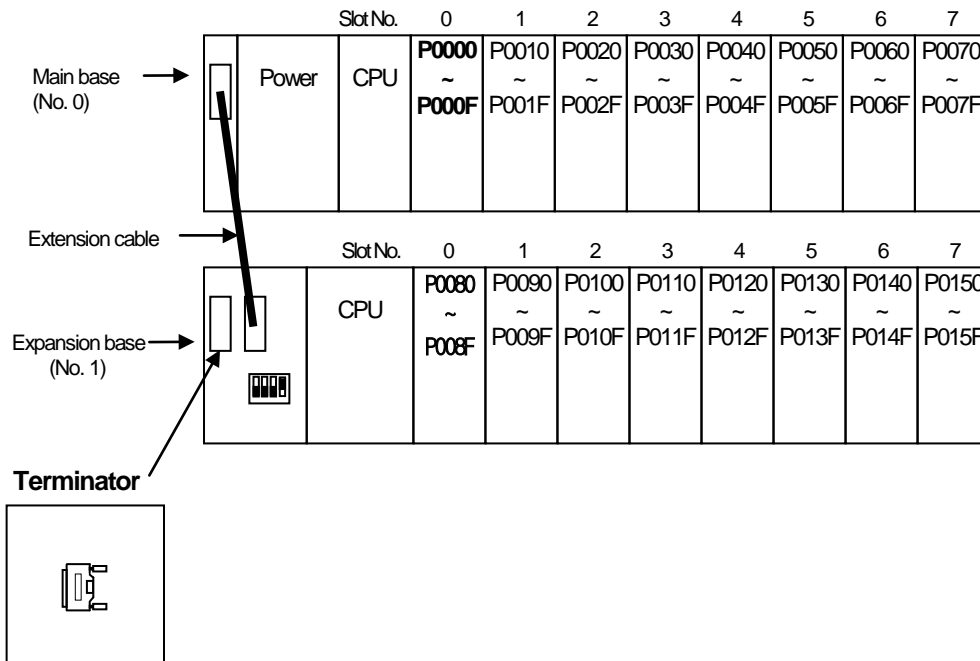



## Chapter 2 System Configuration

### 2.3.5 Module selection when configuring basic system

When configuring basic system, you must consider about size of each module's Data Refresh area. Data Refresh area is used for data transmission between CPU and modules in XGK/XGI CPU system. Data Refresh area is allocated to CPU memory, irrespective of module's operation. You must consider about maximum size of Data Refresh area. If it exceeds 1,024 words, system doesn't operate properly.

#### 2.3.5.1 Size of each module's Data Refresh area

(Unit : WORD)

Item	Type	Refresh Size	Item	Type	Refresh Size
Digital input module	XGI-A12A	1	Digital output module	XGQ-RY1A	1
	XGI-A21A	1		XGQ-RY2A	1
	XGI-A21C	1		XGQ-RY2B	1
	XGI-D21A	1		XGQ-SS2A	1
	XGI-D22A/B	1		XGQ-TR1C	1
	XGI-D24A/B	2		XGQ-TR2A/B	2
	XGI-D28A/B	4		XGQ-TR4A/B	4
Digital I/O module	XGH-DT4A	2		XGQ-TR8A/B	8
Analog input module	XGF-AC8A	22	Temperature detector input module	XGF-RD4A	30
	XGF-AV8A	22		XGF-RD4S	30
	XGF-AD8A	22		XGF-TC4S	30
	XGF-AD16A	21	Temperature control module	XGF-RD8A	23
	XGF-AD4S	12		XGF-TC4RT	31
	XGF-AW4S	12		XGF-TC4UD	31
	XGF-AC4H	11		High speed counter module	XGF-HO2A
Analog output module	XGF-DC8A	11	XGF-HD2A		25
	XGF-DV8A	11	XGF-HO8A		25
	XGF-DC4A	11	SOE module	XGF-SOEA	2
	XGF-DV4A	11	Data log module	XGF-DL16A	32
	XGF-DC4S	11	Communication module	XGL-EFMT	16
	XGF-DV4S	11		XGL-EFMF	16
	XGF-DC4H	7		XGL-ESHF	16
Analog I/O module	XGF-AH6A	11		XGL-DMEA	16
	XGF-PO1A	2		XGL-PSEA	16
APM module ( Advanced Position module )	XGF-PO2A	2		XGL-PMEA	16
	XGF-PO3A	2		XGL-PMEC	16
	XGF-PD1A	2		XGL-EDMT	16
	XGF-PD2A	2		XGL-EDMF	16
	XGF-PD3A	2		XGL-EDST	16
	XGF-PO1H	2	XGL-EDSF	16	
	XGF-PO2H	2	XGL-RMEA	16	

Item	Type	Refresh Size	Item	Type	Refresh Size
APM module ( Advanced Position module )	XGF-PO3H	2	Communication module	XGL-FMEA	16
	XGF-PO4H	2		XGL-C22A	16
	XGF-PD1H	2		XGL-C42A	16
	XGF-PD2H	2		XGL-CH2A	16
	XGF-PD3H	2		XGL-EIMT	16
	XGF-PD4H	2		XGL-EIMH	16
	XGF-PN8A	3		XGL-EIMF	16
	XGF-PN8B	3		XGL-ES4T	16
	XGF-M16M	1		XGL-BBM	16
	XGF-M32E	4		XGL-EIPT	16

### 2.3.5.2 Calculation of Data Refresh area's size

#### 1) Limit of Data Refresh area's size

Sum of Data Refresh area's size installed in system  $\leq$  1,024 words

#### 2) Example

In a system, below modules are installed.

XGI-D28A(20 EA), XGQ-D24A(10EA), XGF-AC8A(20EA), XGF-RD4A(10EA)

$\rightarrow (4 * 20) + (2 * 10) + (22 * 20) + (30 * 10) = 840 \text{ words} \leq 1,024 \text{ words}$

#### Note

- 1) Sum of Data Refresh area's size must not exceed 1,024 words.
- 2) If size of Data Refresh area exceeds 1,024 words, XGK/I system doesn't operate properly.

### 2.4 Network System

XG series provides various network system for easy system configuration. This provides Ethernet (FEnet, FDEnet) and Cnet for communication between PLC and upper system or between PLCs and provides a dedicated Ethernet (FDEnet), Profibus-DP, DeviceNet, Rnet etc. as lower control network system.

#### 2.4.1 Network Systems

##### (1) Local Network

It is available to install max. 24 communication module without any constraint of Main base and Expanded base. It is recommended to install the module with lots of communication capacity in Main base considering system operation and performance. The constraints per function are shown on the table as below.

Classification per purpose	XGK-CPUE	XGK-CPUS	XGK-CPUA	XGK-CPUH	XGK-CPU
		XGK-CPUSN		XGK-CPUHN	XGK-CPUUN
No. of max. high speed link setting module			12		
No. of max. P2P service module			8		
No. of max. dedicated service module			24		

\*Note 1) P2P service : 1 : 1 communication

##### (2) Computer Link (Cnet I/F) System

Cnet I/F system is the system to carry out the data communication between computer or various external equipment and CPU module by using RS-232C, RS-422 (or RS-485) port of Cnet module. For further information of Cnet module, please refer to the user's manual related to Cnet module.

As mentioned on the above "Local Network", Cnet module is available to install max. 24 bases (including other communication module) regardless Main base and Expanded base.

Cnet does not provide high speed link but supports P2P service up to 8.

#### 2.4.2 OS Version of Communication module

##### (1) O/S version of communication module applicable to XGK system

O/S version of communication module applicable to XGK system is as follows.

Name	Module							
	FEnet	FDEnet	Cnet	Rnet	Pnet	Dnet	RAPEnet	IFOS module
Model	XGL-EFMT XGL-EFMF	XGL-EDMT XGL-EDMF	XGL-C22A XGL-CH2A XGL-C42A	XGL-RMEA	XGL-PMEA	XGL-DMEA	XGL-EIMF XGL-EIMT XGL-EIMH	XGL-ESHF
Applicable version	V2.0 or above	V2.0 or above	V2.1 or above	V1.0 or above	V1.0 or above	V1.0 or above	V1.0 or above	V1.0 or above

### 2.4.3 Remote I/O System

This is the network system to control I/O module installed at far distance. Network system such as Profibus-DP, DeviceNet, Rnet, Cnet etc is applied.

#### (1) I/O System Application per Network Type

Remote I/O module is classified by base board type and block type (Smart I/O etc.) and there might be the one that does not support base board type according to network.

Network type (master)	Smart IO	
	Block type	Expansion type
Profibus-DP	○	○
DeviceNet	○	○
Rnet	○	○
Modbus(Cnet)	○	-
FEnet	-	○
Ethernet/IP	-	○
RAPIDnet	-	-

\* The above description is subject to change for function improvement. For correct information, please refer to each network system manual.

Max. no. of installation and max. no. of module per service is the same as local network. In case that I/O module and Special module are installed together in Rack type Remote, one remote master module shall use 1 high speed link and 1 P2P.

#### (2) Block Type Remote I/O System

##### 1) System Configuration

This system is configured by Profibus-DP, DeviceNet and Rnet and it is available to use block type Remote I/O regardless of the series. Profibus-DP and DeviceNet were developed based on International Standard which enables to connect with Smart-I/O of our company as well as the product of other manufacturer.

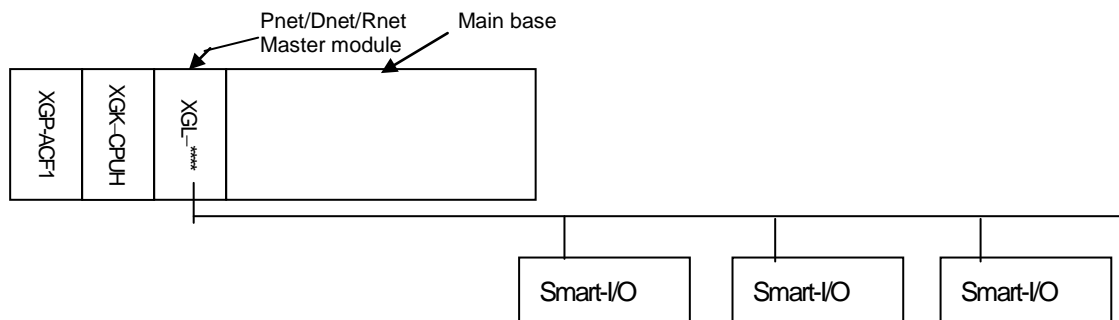

- Master module is available to install up to max. 12 and also available in the expanded base.

##### 2) I/O allocation method and I/O no. assignment

- It is available to allocate 'P', 'M', 'K' and 'D' device to Remote I/O by high speed link parameter. 'P' area is recommended to use the forced ON/OFF function and initial reset function.
- Max. available point of I/O device (P area) is 32,768 point(P00000 ~P2047F).
- For the setting method of high speed link parameter per module, please refer to XG-PD manual.

## Chapter 3 General Specifications

### 3.1 General Specifications

The General Specification of XGT series is as below.

No.	Items	Specifications	Related standards				
1	Ambient temperature	0 ~ 55 °C					
2	Storage temperature	-25 ~ +70 °C					
3	Ambient humidity	5 ~ 95%RH (Non-condensing)					
4	Storage humidity	5 ~ 95%RH (Non-condensing)					
5	Vibration resistance	Occasional vibration			-	10 times each directions (X, Y and Z)	IEC61131-2
		Frequency	Acceleration	Amplitude	times		
		$5 \leq f < 8.4 \text{ Hz}$	-	3.5mm			
		$8.4 \leq f \leq 150\text{Hz}$	$9.8\text{m/s}^2(1\text{G})$	-			
		Continuous vibration					
		Frequency	Acceleration	Amplitude			
	$5 \leq f < 8.4 \text{ Hz}$	-	1.75mm				
	$8.4 \leq f \leq 150\text{Hz}$	$4.9\text{m/s}^2(0.5\text{G})$	-				
6	Shock resistance	<ul style="list-style-type: none"> <li>Peak acceleration: <math>147 \text{ m/s}^2(15\text{G})</math></li> <li>Duration: 11ms</li> <li>Half-sine, 3 times each direction per each axis</li> </ul>	IEC61131-2				
7	Noise resistance	Square wave Impulse noise	$\pm 1,500 \text{ V}$	LSIS standard			
		Electrostatic discharge	4kV	IEC61131-2 IEC61000-1-2			
		Radiated electromagnetic field noise	80 ~ 1,000 MHz, 10V/m	IEC61131-2, IEC61000-1-3			
		Fast transient/bust noise	Segment Voltage	Power supply module 2kV	Digital/analog input/output communication interface 1kV	IEC61131-2 IEC61000-1-4	
8	Environment	Free from corrosive gasses and excessive dust					
9	Altitude	Up to 2,000 ms					
10	Pollution degree	2 or less					
11	Cooling	Air-cooling					

#### Note

1) IEC (International Electrotechnical Commission):

An international nongovernmental organization which promotes internationally cooperated standardization in electric/electronic field, publishes international standards and manages applicable estimation system related with.

2) Pollution degree:

An index indicating pollution degree of the operating environment which decides insulation performance of the devices. For instance, Pollution degree 2 indicates the state generally that only non-conductive pollution occurs. However, this state contains temporary conduction due to dew produced.

## Chapter 4 CPU Module

### 4.1 Technical Specifications

There are 4 types of CPU modules; Standard type (XGK-CPUS), Economic type (XGK-CPUE), Advanced type (XGK-CPUA) and High Performance type (XGK-CPUH), and their technical specifications are as follows.

Items		Specification					Remarks
		XGK-CPUE	XGK-CPUS	XGK-CPUA	XGK-CPUH	XGK-CPUU	
Operation method		Cyclic, Time-driven, Fixed Period					-
I/O control method		Scan synchronized batch method (refresh method), direct method by instruction					-
Program language		Ladder Diagram Instruction List SFC (Sequential Function Chart) ST (Structured Text)					-
Number of instructions	Basic	40					-
	Application	700					-
Processing speed (Basic instruction)	LD	84 ns/Step		28 ns/Step			-
	MOV	252 ns/Step		84 ns/Step			-
	Real number operation	±: 1,442 ns(S), 2,870 ns(D) x : 1,948 ns(S), 4,186 ns(D) ÷ : 1,974 ns(S), 4,200 ns(D)		±: 602 ns(S), 1,078 ns(D) x : 1,106 ns(S), 2,394 ns(D) ÷ : 1,134 ns(S), 2,660 ns(D)			S: Single real number D: Double real number
Programming memory capacity (When check auto-allocation)		16kstep (64KB)	32kstep (128KB)	32kstep (128KB)	64kstep (256KB)	128kstep (512KB)	-
I/O point (setting available)		1,536	3,072	3,072	6,144		-
Data area	P	P00000 ~ P2047F (32,768 point)					-
	M	M00000 ~ M2047F (32,768 point)					-
	K	K00000 ~ K2047F (32,768 point)					-
	L	L00000 ~ L11263F (180,224 point)					-
	F	F00000 ~ F2047F (32,768 point)					-
	T	100ms: T0000 – T0999 1ms: T1500 – T1999		10ms: T1000 – T1499 0.1ms: T2000 – T2047			Change area is available by parameter setting
	C	C0000 ~ C2047					
	S	S00.00 ~ S127.99					
	D	D0000 ~ D19,999		D0000 ~ D32,767			
	U	U0.0 ~ U1F.31	U0.0 ~ U3F.31	U0.0 ~ U3F.31	U0.0 ~ U7F.31		Special module data refresh area
	Z	128 points					Index
	N	N00000 ~ N21,503					
R	1 block		2 block			32K word per 1 block (R0 ~ R32767)	
Flash area		2 Mbyte, 32 block					Controlled by R device

## Chapter 4 CPU Module

Items		Specification					Remarks
		XGK-CPUE	XGK-CPUS	XGK-CPUA	XGK-CPUH	XGK-CPUU	
Program configuration	Total number of program	256					
	Initialization task	1					
	Cyclic task	32					
	Internal device task	32					
Operation mode		RUN, STOP, DEBUG					
Self-diagnosis		Operation delay monitoring, memory error, input/output error, battery error, power error etc.					
Program port		RS-232C(1CH), USB(1CH)					Modbus slave supported via RS-232C port
Data storage method at power off		Latch area setting at Basic parameter					
Max. base expansion		1 stages	3 stages	3 stages	7 stages	Max. 15m	
Internal consumption current		940mA		960mA			
Weight		0.12kg					

### Note

- Supported functions according to CPU OS version: the following OS version and XG500 version is needed for each function

CPU OS	XG5000	Function	Remark
V3.0	V3.0	SFC, ST language Automatic assignment variable	-
V3.1	V3.1	Event input module(XGF-SOEA)	-
V3.2	V3.2	Effective conversion value, alarm function of analog input module	-
V3.4	V3.3	User defined function/function block for XGK Instruction for positioning (APM/XPM): VRD, VWR, XVRD, XVWR	-
V3.50	V3.4	Enhanced password function (in order to connect, XG5000 V3.4 or above is needed.) You can disable the Reset/D.Clear switch Version information is indicated to two decimal places (_OS_VER_PATCH flag added)	-
V3.60	V3.5	Instruction : TRAMP, RTRAMP, VTPP, XVTPP	
V3.70	V3.6	Scan time of fixed cycle task flag P2P, HS enable-disable flag SOE flag	

The performance specifications of the CPU module (XGK-CPUUN/CPUHN/CPUSN) are as follows.

Items		Specification			Remarks
		XGK-CPUSN	XGK-CPUHN	XGK-CPUUN	
Operation method		Cyclic, Time-driven, Fixed Period			-
I/O control method		Scan synchronized batch method (refresh method), direct method by instruction			-
Program language		Ladder Diagram Instruction List SFC (Sequential Function Chart) ST (Structured Text)			-
Number of instructions	Basic	40			-
	Application	700			-
Processing speed (Basic instruction)	LD	8.5 ns/Step			-
	MOV	25.5 ns/Step			-
	Real number operation	$\pm$ : 182.8ns (S), 327.3ns (D) x : 336ns (S), 727ns (D) $\div$ : 345ns (S), 808ns (D)			S: Single real number D: Double real number
Programming memory capacity (When check auto-allocation)		64kstep (256KB)	128kstep (512KB)	256kstep (1,024KB)	-
I/O point (setting available)		3,072	6,144		-
Data area	P	P00000 ~ P4095F (65,536 point)			-
	M	M00000 ~ M4095F (65,536 point)			-
	K	K00000 ~ K4095F (65,536 point)			-
	L	L00000 ~ L11263F (180,224 point)			-
	F	F00000 ~ F4095F (65,536 point)			-
	T	100ms: T0000 – T2999 1ms: T6000 – T7999	10ms: T3000 – T5999 0.1ms: T8000 – T8191	Change area is available by parameter setting	
	C	C0000 ~ C4095			-
	S	S00.00 ~ S255.99			-
	D	D0000 ~ D262143	D0000 ~ D524287		-
	U	U0.0 ~ U3F.31	U0.0 ~ U7F.31		Special module data refresh area
	Z	256 points			Index
	N	N00000 ~ N21503			-
	R	2 block	8 block	16 block	32K word per 1 block (R0 ~ R32767)
Flash area		2 Mbyte, 32 block			Controlled by R device



## Chapter 4 CPU Module

Items		Specification			Remarks
		XGK-CPUSN	XGK-CPUHN	XGK-CPUUN	
Program configuration	Total number of program	256			-
	Initialization task	1			-
	Cyclic task	32			-
	Internal device task	32			-
Operation mode		RUN, STOP, DEBUG			-
Self-diagnosis		Operation delay monitoring, memory error, input/output error, battery error, power error etc.			-
Program port		USB(1CH), Ethernet(1CH)			
Data storage method at power off		Latch area setting at Basic parameter			-
Max. base expansion		3 stages	7 stages		Max. 15m
Internal consumption current		960mA			-
Weight		0.12kg			-

XGK-CPUUN/CPUHN/CPUSN has Ethernet communication. Performance Specifications are as follows.

Item		Specifications XGK-CPUSN/CPUHN/CPUUN	Remarks
Ethernet	Features	1 Port	-
		10/100BASE-TX	-
		Auto negotiation (Full-duplex and half duplex)	-
		Auto MDIX Crossover	-
		Max. Support 4 channel	Support 8Kbyte each send and receive channel
		Max. Distance between nodes : 100m	-
		Max. Protocol size : 1500Byte	IP Fragmentation is not supported.
		UTP, STP, FTP cables is available	FTP, STP is recommended to prevent noise
	Service	Setting communication parameters with XG5000	-
		Loader service (XG5000 connection) supported	remote stage 1 connection with PLC is available
		LS protocol(XGT) supported.	Server function & TCP supported.
		other company's protocol (MODBUS TCP/IP) supported	UDP not supported.

**Note**

- Supported functions according to CPU OS version: the following OS version and XG500 version is needed for each function.

CPU OS	XG5000	Function	Remark
V1.0	V4.0	XGK-CPUUN/CPUHN/CPUSN are added.	-

**4.2 Part Names and Functions**

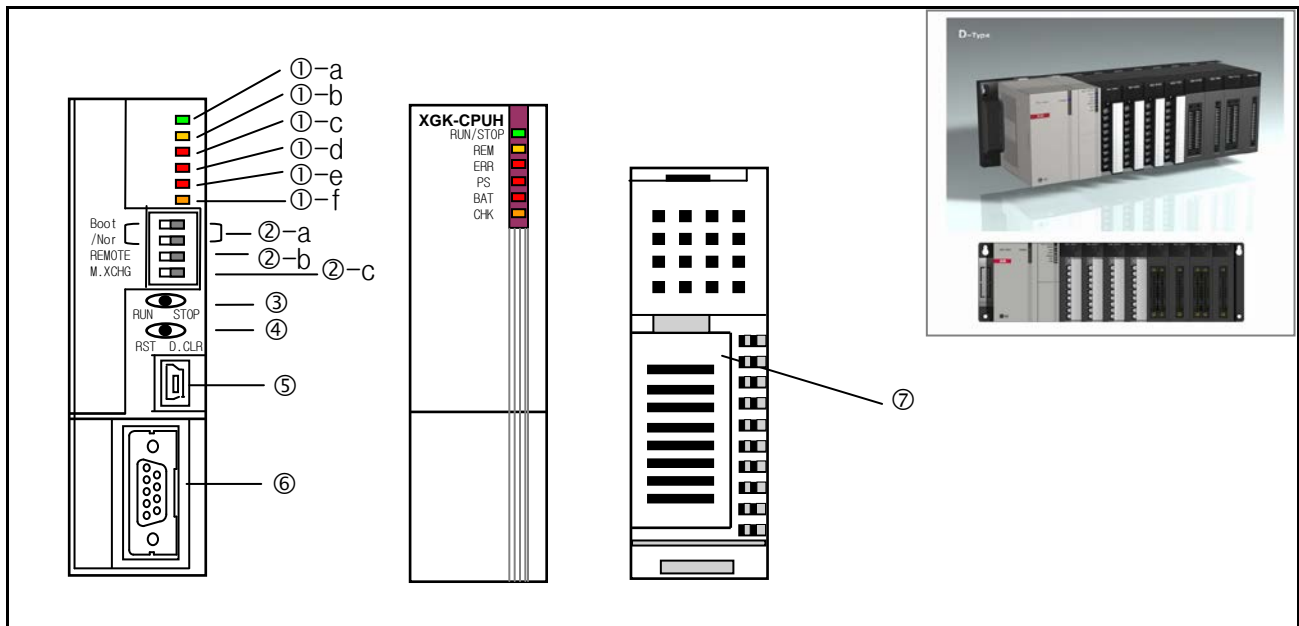

No.	Names	Description
①-a	RUN/STOP LED	<p>This indicates the operation state of CPU module.</p> <ul style="list-style-type: none"> <li>• Green ON: indicates 'in operation' by 'RUN' mode state. <ul style="list-style-type: none"> <li>▶ 'RUN' operation by RUN/STOP mode switch</li> <li>▶ 'REMOTE RUN' operation in the state that mode switch is at 'STOP'</li> </ul> </li> <li>• Red ON: indicates 'in operation' by 'STOP' mode state <ul style="list-style-type: none"> <li>▶ 'STOP' operation by RUN/STOP mode switch</li> <li>▶ REMOTE 'STOP' operation in the state that mode switch is at 'STOP'</li> </ul> </li> </ul>
①-b	REM LED	<ul style="list-style-type: none"> <li>• ON (Yellow): indicates 'remote enabled' <ul style="list-style-type: none"> <li>▶ In case that 'REMOTE' switch is 'On'</li> </ul> </li> <li>• OFF: indicates 'remote disabled' <ul style="list-style-type: none"> <li>▶ In case that 'REMOTE' switch is 'Off'</li> </ul> </li> </ul>

## Chapter 4 CPU Module

No.	Names	Description
①-c	ERR LED	<ul style="list-style-type: none"> <li>• ON (Red): indicates that the error not possible to operate occurred.</li> <li>• OFF: indicates 'no error'</li> </ul>
①-d	PS LED (Programmable Status)	<ul style="list-style-type: none"> <li>• ON (Red): <ul style="list-style-type: none"> <li>▶ In case that 'user assigned flag' is 'On'</li> <li>▶ 'In case of operating in the error state by 'operation proceeding in the error' setting</li> <li>▶ 'In case that the module is detached or other module is installed in the state that 'M.XCHG' switch is 'On'</li> </ul> </li> <li>• OFF: <ul style="list-style-type: none"> <li>▶ Indicates 'no error'</li> </ul> </li> </ul>
①-e	BAT LED	<ul style="list-style-type: none"> <li>• ON (Red): in case that battery voltage is lowered</li> <li>• OFF: no battery error</li> </ul>
①-f	CHK LED	<ul style="list-style-type: none"> <li>• ON (Red): indicates the setting is different from standard setting (Available to add/delete[clear] by parameter) <ul style="list-style-type: none"> <li>▶ In case that 'Module change' switch is set as 'Module change'</li> <li>▶ 'In case of operating in 'DEBUG mode'</li> <li>▶ 'Forced ON' setting state</li> <li>▶ In case that 'fault mask', 'SKIP' flag is set</li> <li>▶ In case that Warning occurs during operation</li> <li>▶ Extended base power error</li> </ul> </li> <li>• Blink: indicates in case arithmetic error occurs during Program Proceeding is set.</li> <li>• OFF: indicates during operation by standard setting</li> </ul>
②-a	Boot/Nor switch	<p>Used when downloading the O/S before releasing.</p> <ul style="list-style-type: none"> <li>• On (right): executes control action in normal operation mode.</li> <li>• Off (left): used for manufacturing, user's operation prohibited. (Download mode of O/S)</li> <li>• Note: Boot/Nor switches should be both set in On (right) side. If set in Off (left) side, it may cause abnormal operation.</li> </ul>
②-b	REMOTE enabled switch	<p>Limits the operation of PLC by remote connection.</p> <ul style="list-style-type: none"> <li>• On (right): all function enabled (REMOTE mode)</li> <li>• Off (left): remote function limited <ul style="list-style-type: none"> <li>▶ D/L of program, Operation mode limited</li> <li>▶ Monitor, data change enabled</li> </ul> </li> </ul>
②-c	M.XCHG (Module change switch)	<p>Used in case of performing the module change during operation.</p> <ul style="list-style-type: none"> <li>• On (right): performs the module change <ul style="list-style-type: none"> <li>▶ Available to change the module only by key switch operation</li> </ul> </li> <li>• Off (left): completes the module change</li> </ul>
③	RUN/STOP mode switch	<p>Sets the operation mode of CPU module.</p> <ul style="list-style-type: none"> <li>• STOP → RUN : executes the operation of program</li> <li>• RUN → STOP : stops the operation of program</li> </ul> <p>Operates prior to REMOTE switch.</p>

No.	Names	Description												
④	Reset/ D.Clear switch	<p>You can enable/disable Reset/D.Clear switch in “XG5000 → Basic Parameter → Basic Operation Setup”</p> <p>1. When Reset switch is enabled</p> <table border="1" data-bbox="555 383 1439 512"> <thead> <tr> <th data-bbox="555 383 997 416">Operation</th> <th data-bbox="997 383 1439 416">Result</th> </tr> </thead> <tbody> <tr> <td data-bbox="555 416 997 450">move to left → return to center</td> <td data-bbox="997 416 1439 450">Reset</td> </tr> <tr> <td data-bbox="555 450 997 512">move to left → keep 3 seconds or above → return to center</td> <td data-bbox="997 450 1439 512">Overall reset</td> </tr> </tbody> </table> <p>2. When D.Clear switch is enabled</p> <table border="1" data-bbox="555 577 1439 797"> <thead> <tr> <th data-bbox="555 577 997 611">Operation</th> <th data-bbox="997 577 1439 611">Result</th> </tr> </thead> <tbody> <tr> <td data-bbox="555 611 997 703">move to right → return to center:</td> <td data-bbox="997 611 1439 703">General data area and retain area (M, Automatic variable) will be cleared.</td> </tr> <tr> <td data-bbox="555 703 997 797">move to left → keep 3 seconds or above → return to center:</td> <td data-bbox="997 703 1439 797">General data area, retain area (M, Automatic variable) and R area will be cleared.</td> </tr> </tbody> </table> <p>• Note: DATA CLEAR acts only in “STOP” operation mode.</p>	Operation	Result	move to left → return to center	Reset	move to left → keep 3 seconds or above → return to center	Overall reset	Operation	Result	move to right → return to center:	General data area and retain area (M, Automatic variable) will be cleared.	move to left → keep 3 seconds or above → return to center:	General data area, retain area (M, Automatic variable) and R area will be cleared.
Operation	Result													
move to left → return to center	Reset													
move to left → keep 3 seconds or above → return to center	Overall reset													
Operation	Result													
move to right → return to center:	General data area and retain area (M, Automatic variable) will be cleared.													
move to left → keep 3 seconds or above → return to center:	General data area, retain area (M, Automatic variable) and R area will be cleared.													
⑤	USB connector	A connector to connect with peripherals (XG5000 etc.) (USB 1.1 support)												
⑥	RS-232C connector	<p>A connector to connect with peripherals</p> <ul style="list-style-type: none"> <li>• XG5000 connection: support basically</li> <li>• Modbus equipment connection: Modbus protocol support(Only as Server) TX: no.7 Pin, RX: no.8 Pin, GND: no.5 Pin</li> </ul>												
⑦	Battery built-in cover	Back-up battery built-in cover												

## Chapter 4 CPU Module

The name of each part about XGK-CPUUN/CPUHN/CPUSN is as followings.

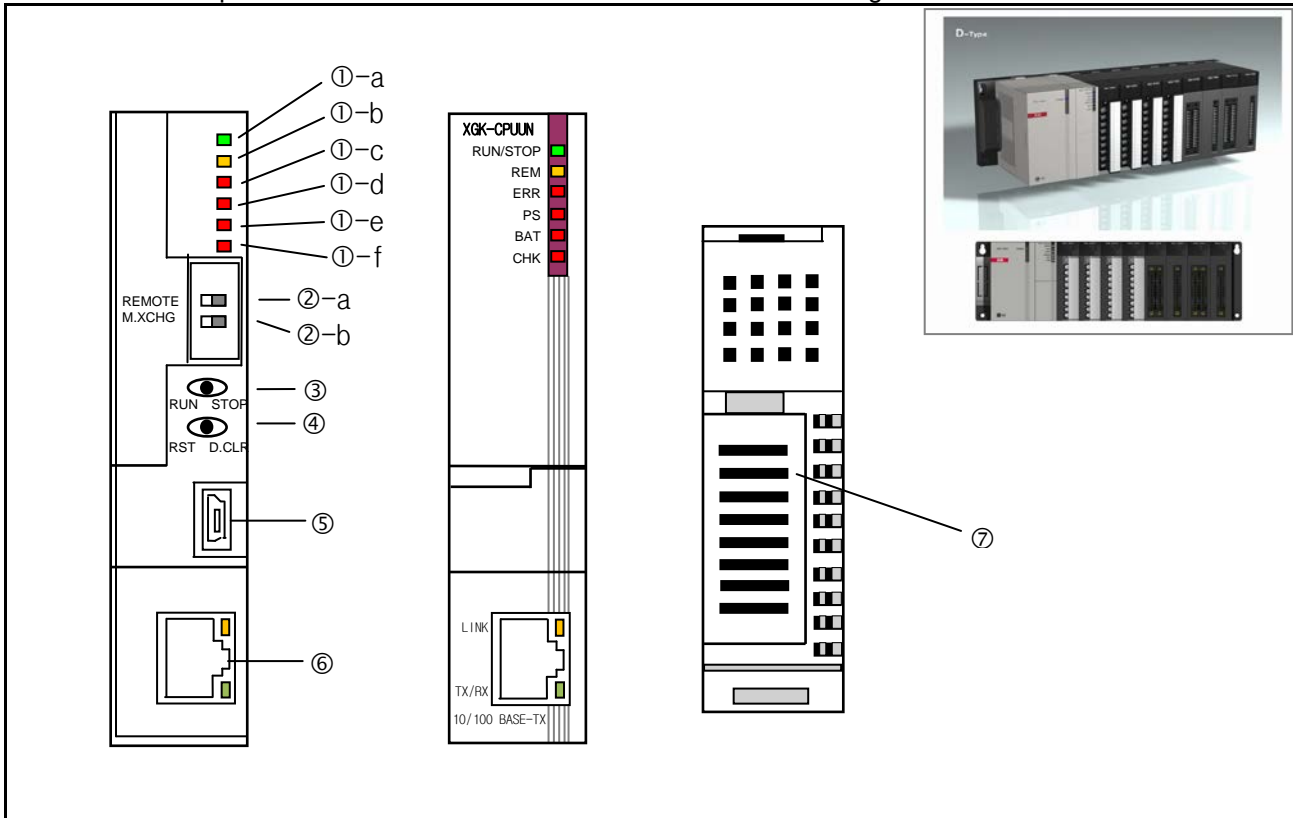

No.	Name	Description
① - a	RUN/STOP LED	<p>Shows the operation status of the CPU module.</p> <ul style="list-style-type: none"> <li>• Green light: 'RUN' mode; the module is in operation <ul style="list-style-type: none"> <li>▶ 'RUN' operation by RUN/STOP mode switch</li> <li>▶ 'Remote RUN' operation with RUN/STOP mode switch in 'STOP'</li> </ul> </li> <li>• Red light: 'STOP' mode; the module is in operation <ul style="list-style-type: none"> <li>▶ 'STOP' operation by RUN/STOP mode switch</li> <li>▶ 'Remote STOP' operation with Mode switch in 'STOP'</li> <li>▶ If an error causing the suspension of operation is detected</li> </ul> </li> </ul>
① - b	REM LED	<ul style="list-style-type: none"> <li>• On(yellow): remote enabled <ul style="list-style-type: none"> <li>▶ If 'REMOTE' switch is 'On';</li> </ul> </li> <li>• Off: remote disabled <ul style="list-style-type: none"> <li>▶ If 'REMOTE' switch is 'Off'</li> </ul> </li> </ul>

No.	Name	Description
① - c	ERR LED	<ul style="list-style-type: none"> <li>• On(red): displaying an error of operation disabled</li> <li>• Off: displaying normal operation</li> </ul>
① - d	PS LED (Programmable Status)	<ul style="list-style-type: none"> <li>• On(red): <ul style="list-style-type: none"> <li>▶ If 'User Defined Flag' is 'On'</li> <li>▶ Operation in erroneous status by 'Operation in Error Status' setting</li> <li>▶ If removing the module or installing other module with 'M.XCHG' switch 'On'</li> </ul> </li> <li>• Off: <ul style="list-style-type: none"> <li>▶ displaying normal operation</li> </ul> </li> </ul>
① - e	BAT LED	<ul style="list-style-type: none"> <li>• On(red): low battery voltage</li> <li>• Off: normal battery level</li> </ul>
① - f	CHK LED	<ul style="list-style-type: none"> <li>• On(red): displayed if other settings but the standard setting is set (it can be added/deleted(cancelled) by parameters) <ul style="list-style-type: none"> <li>▶ If 'Module Change' switch is set to 'Module Change'</li> <li>▶ If operating in 'Debug Mode'</li> <li>▶ If 'Forcible On' setting</li> <li>▶ If 'Fault Mask'/ 'SKIP' flag is set</li> <li>▶ If a warning occurs during operation</li> <li>▶ In case of power fault of extension base</li> </ul> </li> <li>• Off: displayed if operating in standard setting</li> </ul>
② - a	REMOTE Switch	<p>Remotely controlling the operation of PLC.</p> <ul style="list-style-type: none"> <li>• On(right): every function enabled (REMOTE mode)</li> <li>• Off(left): remote functions disabled <ul style="list-style-type: none"> <li>▶ Program D/L, operation mode control limited</li> <li>▶ Monitor and data change allowed</li> </ul> </li> </ul>
② - b	M.XCHG (module change switch)	<p>It replaces a module during operation.</p> <ul style="list-style-type: none"> <li>• On (right): replacing a module <ul style="list-style-type: none"> <li>▶ A module is replaced by operating the key switch</li> </ul> </li> <li>• Off(left): module is replaced completely</li> </ul>
③	RUN/STOP Mode switch	<p>Setting the operation mode of the CPU module.</p> <ul style="list-style-type: none"> <li>• STOP → RUN : execute program operation</li> <li>• RUN → STOP : stop program operation</li> </ul> <p>The control is prior to Remote switch control.</p>

No.	Name	Description												
④	Reset/ D.Clear switch	<p>You can enable/disable Reset/D.Clear switch in “XG5000 → Basic Parameter → Basic Operation Setup”</p> <p>1. When Reset switch is enabled</p> <table border="1"> <thead> <tr> <th>Operation</th> <th>Result</th> </tr> </thead> <tbody> <tr> <td>move to left → return to center</td> <td>Reset</td> </tr> <tr> <td>move to left → keep 3 seconds or above → return to center</td> <td>Overall reset</td> </tr> </tbody> </table> <p>2. When D.Clear switch is enabled</p> <table border="1"> <thead> <tr> <th>Operation</th> <th>Result</th> </tr> </thead> <tbody> <tr> <td>move to right → return to center:</td> <td>General data area and retain area (M, Automatic variable) will be cleared.</td> </tr> <tr> <td>move to left → keep 3 seconds or above → return to center:</td> <td>General data area, retain area (M, Automatic variable) and R area will be cleared.</td> </tr> </tbody> </table> <ul style="list-style-type: none"> <li>• Data clear process operates only in “STOP” operation mode.</li> </ul>	Operation	Result	move to left → return to center	Reset	move to left → keep 3 seconds or above → return to center	Overall reset	Operation	Result	move to right → return to center:	General data area and retain area (M, Automatic variable) will be cleared.	move to left → keep 3 seconds or above → return to center:	General data area, retain area (M, Automatic variable) and R area will be cleared.
Operation	Result													
move to left → return to center	Reset													
move to left → keep 3 seconds or above → return to center	Overall reset													
Operation	Result													
move to right → return to center:	General data area and retain area (M, Automatic variable) will be cleared.													
move to left → keep 3 seconds or above → return to center:	General data area, retain area (M, Automatic variable) and R area will be cleared.													
⑤	USB connector	Connector for peripherals (XG5000 and etc): USB 1.1 supported												
⑥	Ethernet connector	Connector for peripherals <ul style="list-style-type: none"> <li>• XG5000 connection: basically supported</li> <li>• TCP/IP Server connection</li> </ul>												
⑦	Battery cover	Backup battery cover												

## 4.3 Battery

### 4.3.1 Battery Specifications

Items	Specification
Nominal voltage/current	DC 3.0 V / 1,800 mAh
Warranty	5 years (ambient temperature)
Purpose	Program and data backup, RTC operation when power-off
Specification	Manganese dioxide lithium battery
Outer dimension (mm)	φ 17.0 X 33.5 mm

### 4.3.2 Notice in Using

- 1) Do not apply the heat or solder to the electric pole. (If not, battery life shortening may be caused.)
- 2) Do not measure the voltage with tester or have a short-circuit. (If not, fire or flames may be caused.)
- 3) Do not disassemble the battery.

### 4.3.3 Battery Durability

The durability of battery depends on power-out time, ambient temperature etc. However, these CPUs are designed to use the battery around 5 years under normal circumstances.

If the voltage of battery is lowered, CPU module occurs 'Battery voltage drop warning'. It is available to check it through CPU module LED and flag or error message of XG5000.

As the battery works for an amount of time normally even after 'battery voltage drop warning' occurs, you can take an action after warning in the system of daily checking.

**Notes**

In general, the battery warning occurs 5 years after purchasing but it may occur earlier due to a poor battery or excessive current discharge caused by leakage current etc. If the warning occurs again within the short time after battery change, you need to request A/S service for CPU module.

### 4.3.4 Changing the Battery

The battery used for program backup or data backup at power out needs the regular change. Even if the battery is removed, program and power-out keeping data shall be kept for 30 minutes by super capacity but it is required to change the battery as fast as possible.

The battery change procedure is as below.

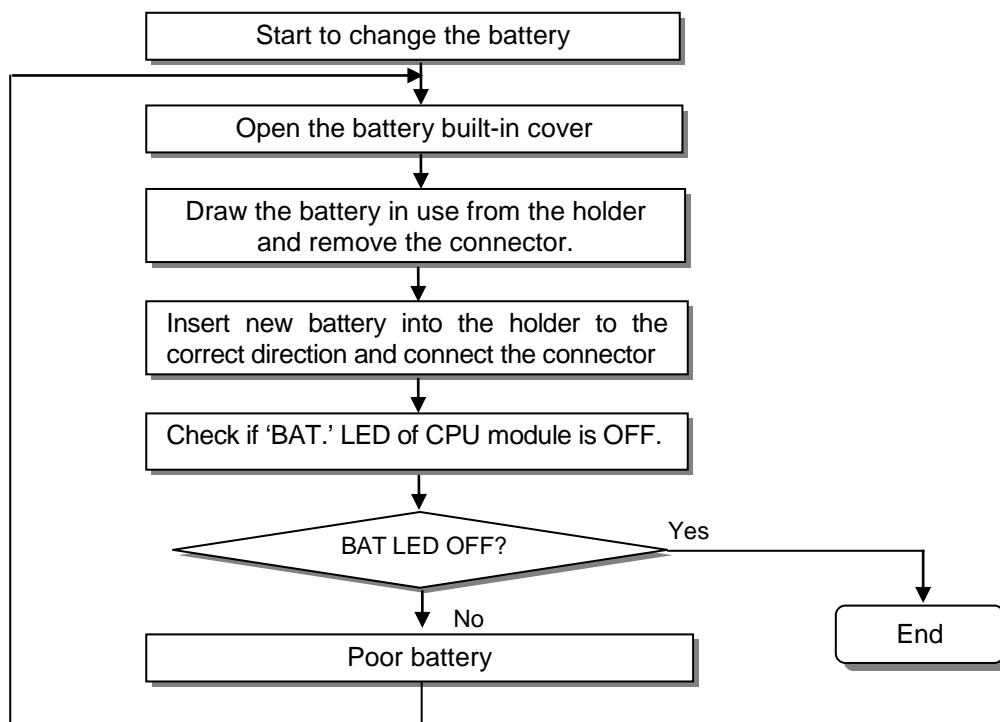



## Chapter 5 Program Configuration and Operation Method

### 5.1 Program Instruction

#### 5.1.1 Program Execution Methods

##### 1) Cyclic operation method (Scan)

This is a basic program proceeding method of PLC that performs the operation repeatedly for the prepared program from the beginning to the last step, which is called 'program scan'. The series of processing like this is called 'cyclic operation method'. The processing is divided per stage as below.

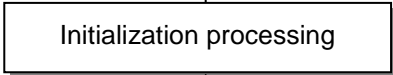
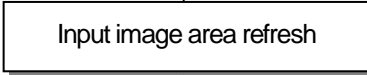
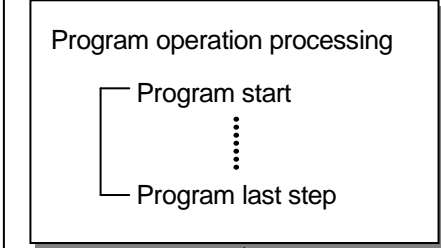
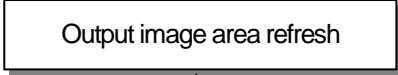
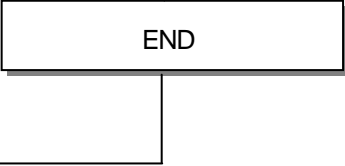
Stage	Processing description
	<ul style="list-style-type: none"> <li>• Supply power &amp; Reset</li> </ul>
	<ul style="list-style-type: none"> <li>• A stage to start the scan processing which is executed once when power is applied or Reset is executed, as below.                             <ul style="list-style-type: none"> <li>▶ I/O module reset      ▶ Self-diagnosis execution</li> <li>▶ Data clear</li> <li>▶ Address allocation of I/O module and type register</li> </ul> </li> </ul>
	<ul style="list-style-type: none"> <li>• Reads the state of input module and saves it in input image area before starting the operation of program.</li> </ul>
	<ul style="list-style-type: none"> <li>• Performs the operation in order from the program start to last step.</li> </ul>
	<ul style="list-style-type: none"> <li>• If the operation of program is completed, it prints out the contents saved in output image area to output module.</li> </ul>
	<ul style="list-style-type: none"> <li>• A processing stage to return to the first step after CPU module completes 1 scan processing and the processing performed is as below.                             <ul style="list-style-type: none"> <li>▶ Update the current value of timer and counter etc.</li> <li>▶ User event, data trace service</li> <li>▶ Self-diagnosis</li> <li>▶ High speed link, P2P e-Service</li> <li>▶ Check the state of key switch for mode setting</li> </ul> </li> </ul>

## 2) Interrupt Operation (Time-driven, Internal Device)

This is the method that stops the program operation in proceeding temporarily and carries out the operation processing which corresponds to interrupt program immediately in case that there occurs the status to process emergently during PLC program execution.

The signal to inform this kind of urgent status to CPU module is called 'interrupt signal' and there is a time-driven method that operates program every appointed time. Besides, there is an internal device start program that starts according to the state change of device assigned inside.

## 3) Constant Scan (Fixed Period)

This is the operation method that performs the scan program every appointed time. This stands by for a while after performing all the scan program, and starts again the program scan when it reaches to the appointed time. The difference from constant program is the update of input/output and the thing to perform with synchronization.

At constant operation, the scan time indicates the net program processing time where the standby time is deducted. In case that scan time is bigger than 'constant', '\_CONSTANT\_ER [F0005C]' flag shall be 'ON'.

### 5.1.2 Operation Processing during Momentary Power Failure

CPU module detects the momentary power failure when input power voltage supplied to power module is lower than the standard. If CPU module detects the momentary power failure, it carries out the operation processing as follows.

#### 1) Momentary power failure within 20ms

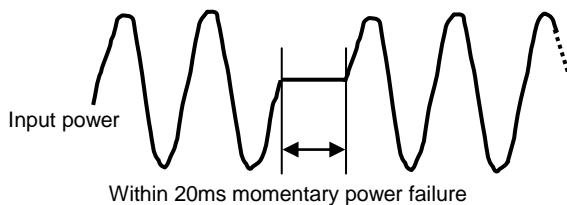

- (1) Stops the operation in the output state when momentary power failure occurred.
- (2) If momentary power failure is released, the operation continues.
- (3) Output voltage of power module keeps the value within the standard.
- (4) Even if the operation stops by momentary power failure, timer measurement and interrupt timer measurement shall be executed normally.

#### 2) Momentary power failure exceeding 20ms

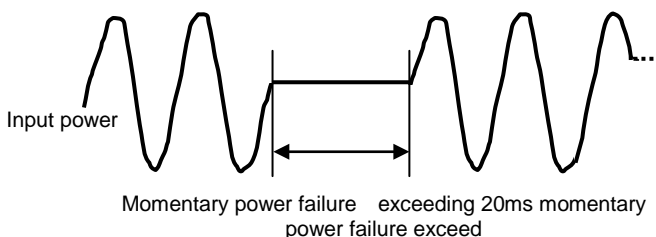

- Restart processing like at power input shall be performed.

#### Notes

##### 1) Momentary power failure?

This means the state that the voltage of supply power at power condition designated by PLC is lowered as it exceeds the allowable variable range and the short time (some ms ~ some dozens ms) interruption is called 'momentary power failure'.

### 5.1.3 Scan Time

The time required to complete it from the first step 0 to the next step 0 of a program, that is, a time taken for a control operation is called 'scan time.' It is directly related to the control performance of the system.

1) Operation and performance of XGK

Program execution time, I/O data process time and communication service time are important factors affecting the 'scan time.'

The XGK impressively reduces scan time by means of the improved data reception performance through backplane, ladder program execution and ladder program execution by MPU and parallel execution of I/O data scan etc.

Type	Program processing time		Module processing time		
	Ladder execution (32kstep)	System Task	Digital I/O module (32 points, 1module)	Analog module (8 ch, 1module)	Communication module (basic/extension) (200 byte, 1 block)
CPUSN/HN/UN	0.272 ms	0.2 ms	20 us	75 us	170 + 44 (200byte 1 block) $\mu$ s
CPUA,H,U	0.896 ms	0.6 ms			
CPUE,S	2.688 ms	0.8 ms			

2) Calculation of scan time

The CPU module executes controls along the following steps. A user can estimate the control performance of a system that the user is to structure from the following calculation.

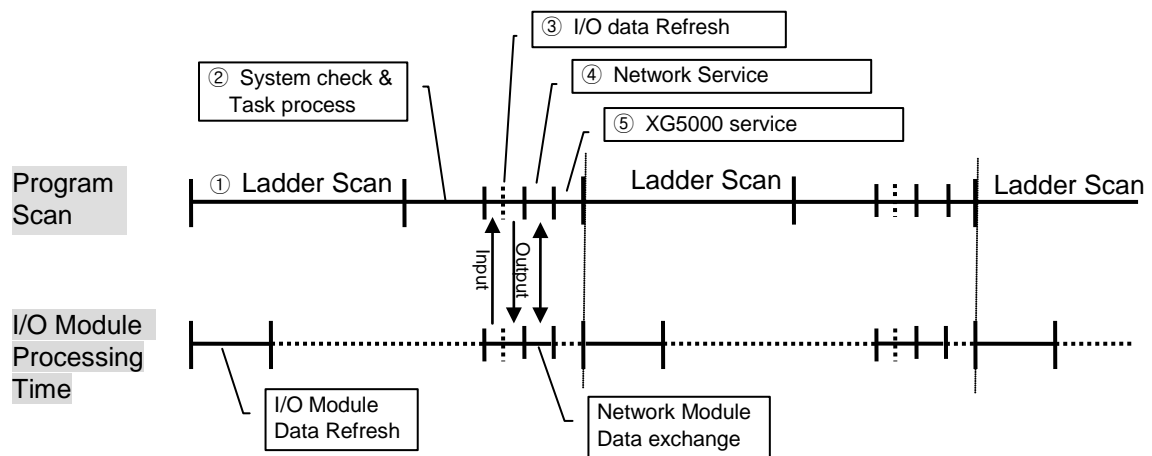

$$(1) \text{ Scan time} = \text{① Scan program process} + \text{② System check \& Task process} + \text{③ I/O data Refresh} + \text{④ Network Service} + \text{⑤ XG5000 Service} + \text{⑥ User Task Program process}$$

- ① Scan program process = no. of program steps created x 0.028 ( $\mu$ s) [0.084 for CPUS]
- ② System check & Task process: 600  $\mu$ s ~ 1.0 ms [parameter depending on the usage of auxiliary functions]
- ③ I/O data Refresh [including special module]: minimum 0.06ms ~ 0.2ms

## Chapter 5 Program Configuration and Operation Method

---

- ④ Network Service = Service of communication module in basic base+ Service of communication module in expansion base
- $$= (\text{No. of Service} \times 3 \mu\text{S}) + (\text{total TRX data}(\text{byte})/4 \times 0.056 [\text{CPUS:0.112}] \mu\text{S})$$
- $$+ (\text{Comm. module TRX data of basic base}(\text{byte})/4 \times 0.084 \mu\text{S})$$
- $$+ (\text{Comm. module TRX data of expansion base}(\text{byte})/4 \times 0.280 \mu\text{S})$$

\* The number of service and TRX data occurred within one scan are standard of calculation

- ⑤ XG5000 Service process time: 100  $\mu\text{S}$  at the max data monitor  
(But, in case of changing the monitor screen, scan time increases for the mean time. In case of connected with "USB Max. Write", 6ms. In case of connected "USB Normal Write", 1.6ms.)
- ⑥ Task Program process time: sum of task processing time that occurs within a scan; the time calculation by task programs are as same as that of scan program.

### (2) Example

The scan time of a system consisting of CPUH (program 16kstep) + six 32-point I/O modules + six analog modules + four communication modules (200 byte 8 blocks per module)

$$\begin{aligned} \text{Scan time}(\mu\text{S}) &= \text{ladder execution time} + \text{system processing time} + \text{digital module I/O processing} \\ &\quad \text{time} + \text{analog I/O processing time} \\ &\quad + \text{communication module processing time} + \text{XG5000 Service processing time} \\ &= (16000 \times 0.028) + (600) + (20 \times 6) + (75 \times 6) + ((170 + 44 \times 8) \times 4) + (100) \\ &= 3806 \mu\text{S} \\ &= 3.806 \text{ ms} \end{aligned}$$

### 2) Scan time monitor

- (1) Scan time is saved into the following flag(F) areas.
- F0050 : max value of scan time (unit: 0.1ms)
  - F0051 : min value of scan time (unit: 0.1ms)
  - F0052 : current scan time value (unit: 0.1ms)

Set the "F" devices as INT type monitoring the scan time.

## 5.2 Program Execution

### 5.2.1 Program Configuration

The program is consisted of all function factors required to execute the specific control and saved in the built-in RM or flash memory of CPU module. These function factors are generally classified as follows.

Function factor	Process description
Scan program	<ul style="list-style-type: none"> <li>• Processing of signal that repeats regularly every 1 scan.</li> </ul>
Time-driven interrupt program	<ul style="list-style-type: none"> <li>• The program is performed according to the fixed time interval in case that the required processing time condition is as below.                             <ul style="list-style-type: none"> <li>▶ In case that the faster processing than 1 scan average processing time is required</li> <li>▶ In case that the longer time interval than 1 scan average processing time is required</li> <li>▶ In case that program is processed with the appointed time interval</li> </ul> </li> </ul>
Subroutine program	<ul style="list-style-type: none"> <li>• Only when some condition is satisfied.(in case that input condition of CALL instruction is On)</li> </ul>

### 5.2.2 Program Execution Method

Here describes the program proceeding method that is executed when the power is applied or key switch is 'RUN'.

The program performs the operation processing according to the configuration as below.

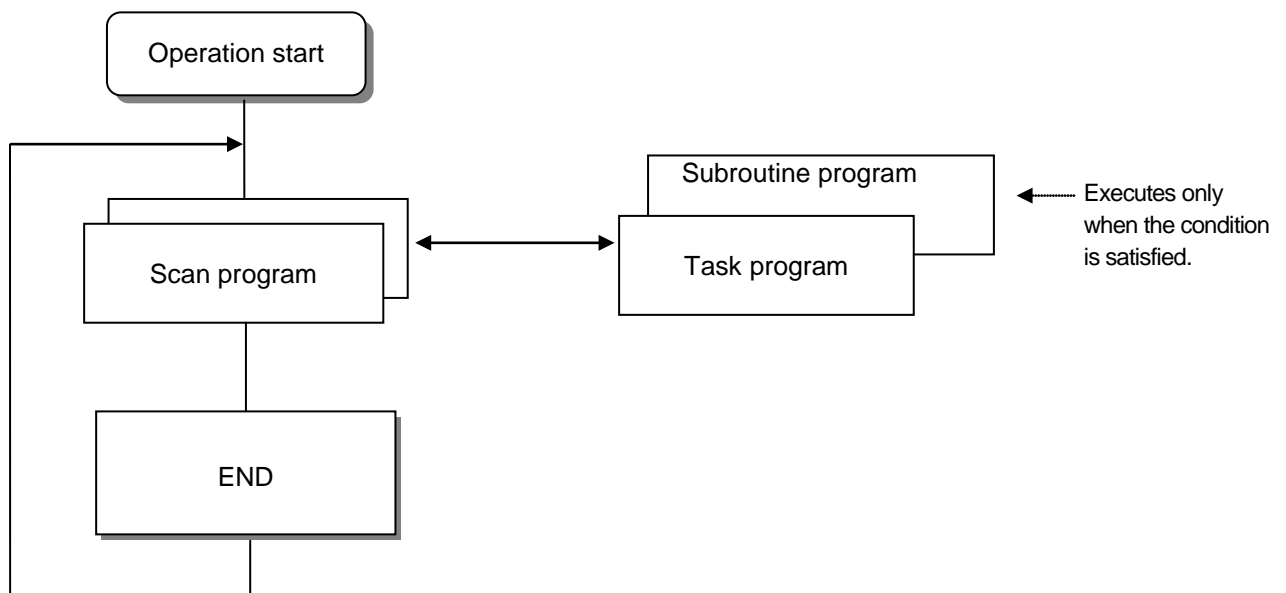

### 1) Scan Program

#### (1) Function

- This program performs the operation repeatedly from 0 step to last step in order prepared by the program to process the signal that is repeatedly regularly every scan.
- In case that the execution condition of interrupt by task interrupt or interrupt module while executing scan program is established, stop the current program in execution and perform the related interrupt program.

### 2) Interrupt Program

#### (1) Function

- This program stops the operation of scan program and then processes the related function in prior to process the internal/external signal occurred periodically/non-periodically.

#### (2) Type

- Task program is divided as below.
  - (a) Time-driven task program : available to use up to 32
  - (b) Internal device task program : available to use up to 32
- Time-driven task program
  - ▶ Performs the program according to the fixed time interval.
- Internal device task program
  - ▶ Performs the corresponding program when the start condition of internal device occurs.
  - ▶ The start condition detection of device shall be performed after processing of scan program.

#### Notes

- 1) For further information of interrupt program, please refer to 5.2.3 Interrupt.

### 5.2.3 Interrupt

For your understanding of Interrupt function, here describes program setting method of XG5000 which is an XGT programming SW. (For further information of XG5000, please refer to XG5000 user's manual)

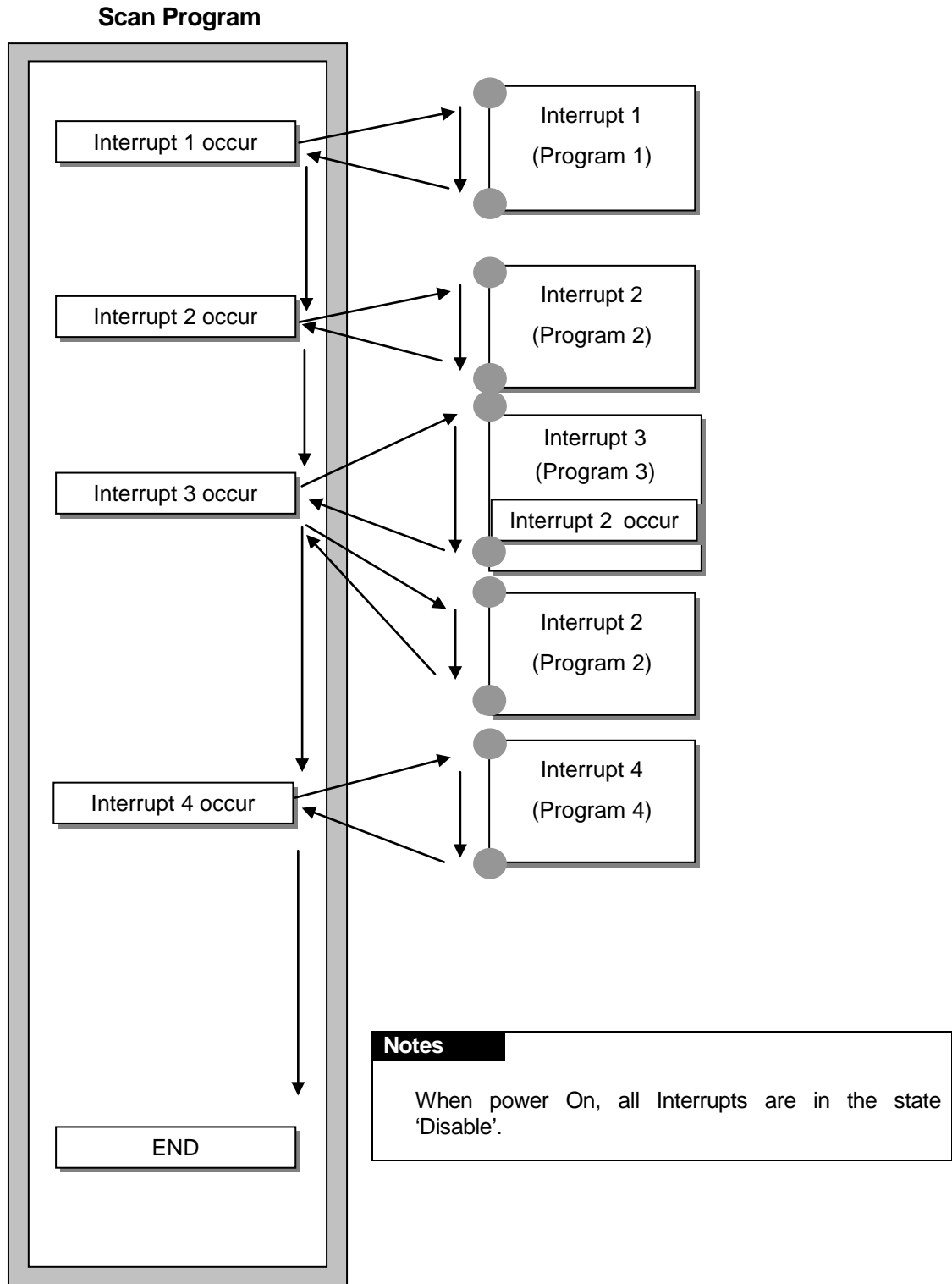

### 1) How to Prepare Interrupt Program

Generate the task in the project window of XG5000 as below and add the program to be performed by each task. For further information, please refer to XG5000 user's manual.

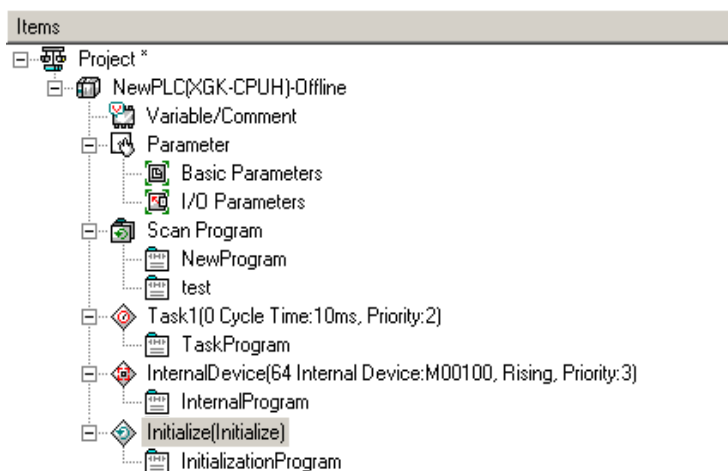

### 2) Task Type

Task type and function is as follows.

Spec \ Type	Cyclic task (interval task)	Internal device task (single task)
Task number	32	32
Start condition	Cyclic (setting up to max. 4,294,967.295 sec. by 1ms unit)	Internal device execution condition
Detection & execution	Cyclic execution per setting time	Retrieve the condition and execute after completing Scan Program
Detection delay time	Max. 0.2 ms delay	Delay as much as max. scan time
Execution priority	2 ~ 7 level setting (2 level is highest in priority.)	Same as left
Task no.	Within 0~31 range without user duplication)	With 64~95 range without user duplication

### 3) Processing Method of Task Program

Here describes common processing method and notices for Task Program.

#### (1) Features of Task Program

- Task Program is executed only when execution condition occurs without every scan repeat processing. When preparing Task Program, please consider this point.
- For example, if a timer and counter were used in cyclic task program of 10 second cycle, this timer occurs the tolerance of max. 10 seconds and the counter and the timer and as the counter checks the input status of counter per 10 seconds, the input changed within 10 seconds is not counted up.



### (2) Execution priority

- In case that several tasks to be executed are waiting, execute from the highest Task Program in priority. When the same priority tasks are waiting, execute from the order occurred.
- Task priority relates to each task.
- The task program priority should be set considering the program features, importance and the emergency when the execution requested.

### (3) Processing delay time

There are some causes for Task Program processing delay as below. Please consider this when task setting or program preparation.

- Task detection delay (Refer to detailed description of each task.)
- Program proceeding delay caused by Priority Task Program proceeding

### (4) Relationship of initialize, Scan Program and Task Program

- User identification task does not start while performing Initialization Task Program.
- As Scan Program is set as lowest priority, if task occurs, stop Scan Program and process Task Program in advance. Accordingly, if task occurs frequently during 1 scan or concentrates intermittently, scan time may extend abnormally. Cares should be taken in case of task condition setting.

### (5) Protection of Program in execution from Task Program

- In case that the continuity of program execution is interrupted by high priority Task Program during program execution, it is available to prohibit the execution of Task Program partially for the part in problem. In this case, it is available to perform the program protection by 'DI(Task Program Start Disabled)' and 'EI(Task Program Start Enabled)' application instruction.
- Insert 'DI' application instruction in the start position of the part requiring the protection and insert 'EI' application instruction in the position to release. Initialization Task is not influenced by 'DI', 'EI' application instruction.

#### Notes

- 1) For further information of interrupt program, please refer to 5.2.3 Interrupt.

## 4) Time Driven Task Program Processing Method

Here describes the processing method in case that task (start condition) of Task Program is set as Time-driven.

### (1) Items to be set in Task

- Set the execution cycle and priority which are the start condition of Task Program to execute. Check the task no. to manage the task.

### (2) Time-driven Task Processing

- Performs the corresponding Time-driven task program per setting time interval (execution cycle).

### (3) Notice in using Time-driven Task Program

- When Time-driven task program is in execution currently or waiting for execution, if the demand to execute the same task program occurs, the new occurred task shall be disregarded.
- Timer that makes a demand to execute Time-driven task program only while operation mode is RUN mode, shall be added. The shutdown time shall be all disregarded.
- When setting the execution cycle of Time-driven task program, consider the possibility that the demand to execute several Time-driven task program at the same time occurs.  
If 4 Time-driven task programs that the cycle is 2sec, 4sec, 10sec and 20sec are used, 4 demands of execution per 20 seconds shall be occurred at the same time and scan time may extend instantaneously.

- You can check maximum, minimum, and current scan time of fixed cycle task with flag of fixed cycle task

`_CYCLE_TASK_SCANx_MAX` : Maximum scan time of number 'x' Time-driven task (x=0~31)

`_CYCLE_TASK_SCANx_MIN` : Minimum scan time of number 'x' Time-driven task

`_CYCLE_TASK_SCANx_CUR` : Current scan time of number 'x' Time-driven task

Initial value of minimum scan time flag is 16#ffff. It can verify fixed cycle task is not used, or never executed.

### 5) Internal Device Task Program Processing Method

Here describes the processing method of Internal Device Task Program which extended the task (start condition) of Task Program from contact point to device as execution range.

#### (1) Items to be set in Task

- Set the execution condition and priority to the task being executed. Check the task no. for task management.

#### (2) Internal Device Task Processing

- After completing the scan program execution in CPU module, if the condition of device that becomes the start condition of internal device task program is met, according to the priority, it shall be executed.

#### (3) Precautions in using internal Device Task Program

- Accordingly, even if the execution condition of internal device task program occurs in Scan Program or Task Program (Time-driven), it shall not be executed immediately but executed at the time of completion of Scan Program.
- If the demand to execute Internal Device Task Program occurs, the execution condition shall be examined at the time of completion of Scan Program. Accordingly, if the execution condition of Internal Device Task occurs by Scan Program or Task Program (Time-driven) during '1 scan' and disappears, the task shall not be executed as it is not possible to detect the execution at the time of examination of execution condition.

### 6) Task Processing at the Momentary power failure

- When restarting the task as the momentary power failure time is long, disregard the task in standby and the task issued during shutdown all and process only the task from the starting point.
- In the shutdown state within 20ms, the task in standby before shutdown shall be executed, after recovering the shutdown. The cyclic task and Interrupt task that occurred in double during shutdown, shall be disregarded.

### 7) Verification of Task Program

Verify the following contents after writing the Task Program.

(1) Is the task setting proper ?

If task occurs frequently more than needed or several tasks occur in one scan at the same time, scan time may lengthen or be irregular. In case not possible to change the task setting, verify max. scan time.

(2) Is the priority of task arranged well?

The low priority task program shall be delayed by the high priority task program, which results in disabling the processing within the correct time and even task collision may occur as next task occurs in the state that the execution of previous task is delayed. Consider the emergency of task and execution time etc when setting the priority.

(3) Is the Task Program written in shortest?

If the execution time of Task Program is longer, scan time may lengthen or be irregular. Even it may cause the collision of task program. Write the execution time as short as possible. (Especially, when writing the cyclic task program, write the execution time so that the task program can be executed within 10% cycle of the shortest task among several tasks.)

(4) Is program protection for the high priority task needed during program execution?

If other task is inserted during task program execution, complete the task in execution and operate the standby tasks in the order of high priority. In case that it is not allowed to insert other task in Scan Program, prevent the insert partially by using 'DI' and 'EI' application instruction. The problem may occur while processing the global variables used commonly with other program or special or communication module.

### 8) Program Configuration and Processing Example

If task and program are registered as below,

- Task registration :
  - T\_SLOW ( cycle time := 10ms, Priority:= 3 )
  - PROC\_1 ( internal device: = M0, Priority := 5 )
- Program registration : Program --> P0
  - Program --> P0 (scan program)
  - Program --> P1 (start by task T\_SLOW)
  - Program --> P2 (start by task PROC\_1)

And program execution time and the occurrence time of interrupt signal is same as follows,

- Execution time of each Program : P0 = 17ms, P1 = 2ms, P2 = 7ms
- PROC\_1 occur: The execution of program occurred during Scan Program is as below.

## Chapter 5 Program Configuration and Operation Method

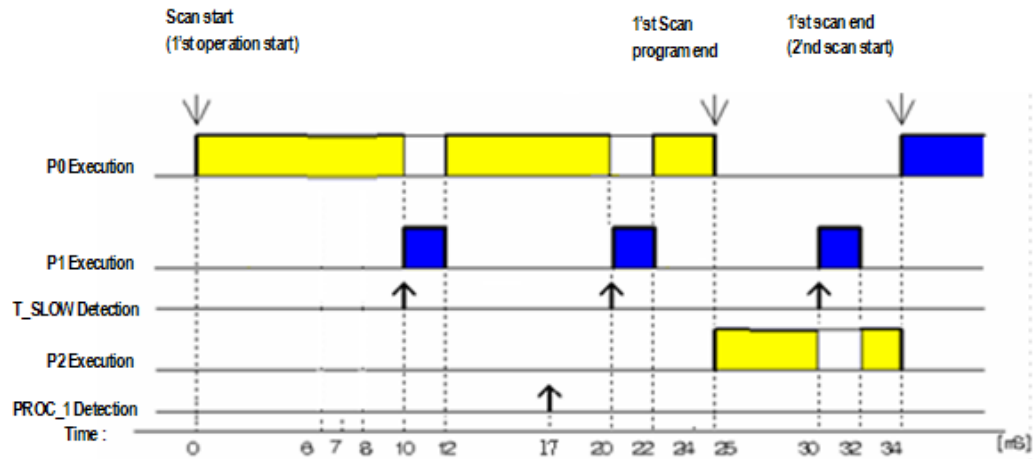

- Process per time

Time (ms)	Process
0	Scan started and scan program P0 started to execute
0~10	Program P0 executed
10~12	P1 execution demand, P0 stopped and P1 executed
17	P2 execution demand
12~20	P1 execution completed and continues the stopped P0
20~22	P1 execution demand, P0 stopped and P1 executed
22~25	P1 execution completed and the stopped P0 execution finished
25	P2 execution demand check at the completion time of Scan Program(P0), and P2 executed
25~30	Program P2 executed
30~32	P1 execution demand, P2 stopped and P1 executed
32~34	P1 execution completed and the stopped P2 execution finished
34	New scan starts (P0 starts to execute)

### 5.3 Operation Mode

For operation mode of CPU module, there are 3 types such as RUN mode, STOP mode and DEBUG mode.. Here describes the operation processing of each operation mode.

#### 5.3.1 RUN Mode

This is the mode to execute Program operation normally.

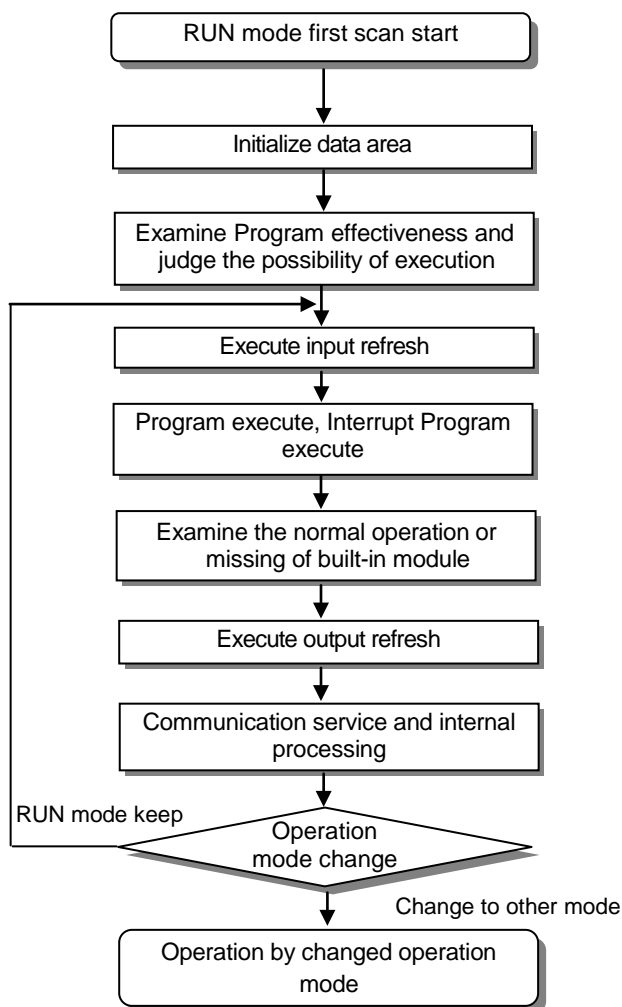

#### 1) Processing at Mode Change

At the beginning, execute initialization of data area and examine the effectiveness of program and judge the possibility of execution.

#### 2) Operation Processing Contents

Execute I/O refresh and Program operation.

- (1) Detects the start condition of Interrupt Program and executes Interrupt Program.
- (2) Examines the normal operation or missing of built-in module.
- (3) Communication service and other internal processing.

### 5.3.2 STOP Mode

This is the mode in stop state without Program operation. It is available to transmit the program through XG5000 only in Remote STOP mode.

- 1) Processing at Mode Change  
Clear the output image area and execute output refresh.
- 2) Operation Processing Contents
  - (1) Executes I/O refresh.
  - (2) Examines the normal operation or missing of built-in module.
  - (3) Communication service or other internal processing.

### 5.3.3 DEBUG Mode

This is the mode to detect Program error or trace the operation process and the conversion to this mode is available only in STOP mode. This is the mode to check the program execution state and the contents of each data and verify the program.

- 1) Processing at Mode Change
  - (1) Initializes the data area at the beginning of mode change.
  - (2) Clears the output image area and execute input refresh.
- 2) Operation Processing Contents
  - (1) Executes I/O refresh.
  - (2) Debug operation according to setting state.
  - (3) After finishing Debug operation by the end of Program, execute output refresh.
  - (4) Examine the normal operation or missing of built-in module.
  - (5) Executes communication service or other service.
- 3) Debug Operation Condition  
There are 4 conditions for Debug operation and in case that it reaches break point, it is available to set other type of break point.

Operation condition	Description
Execute by one operation unit (step over)	With operation instruction, it executes one operation unit and then stops.
Execute according to Break Point	If break point is assigned in Program, it stops at the assigned break point.
Execute according to the state of contact point	If the contact area desired to watch and the state (Read, Write, Value) desired to stop are assigned, it stops when the assigned operation occurs at the assigned contact point.
Execute according to scan times	If scan times to operate are assigned, it operates as much as the assigned scan times and stops.

- 4) Operation Method
  - (1) After setting Debug operation condition at XG5000, execute the operation.
  - (2) Interrupt Program is available to set whether or not to operate (Enable/Disable) by each Interrupt unit.  
(For further information, please refer to Chapter 9 Debugging, XG5000 user's manual.)

### 5.3.4 Changing Operation Mode

1) Operation Mode Change Method

The method to change operation mode are as follows.

- (1) By mode key of CPU module
- (2) By connecting the programming tool (XG5000) to communication port of CPU
- (3) By changing the operation mode of other CPU module connected to network by XG5000 connected to communication port of CPU
- (4) By using XG5000, HMI, computer link module connected to network
- (5) By 'STOP' instruction during program execution

2) Type of Operation Mode

The operation mode setting is as follows.

Operation mode switch	Remote enabled switch	XG5000 instruction	Operation mode
RUN	X	X	Run
STOP	ON	RUN	Remote Run
		STOP	Remote Stop
		Debug	Debug Run
	OFF	Mode change execute	Previous operation mode
RUN -> STOP	X	-	Stop

- (1) Remote mode conversion is available only in the state of '**Remote Enabled: On**', '**Mode switch: Stop**'.
- (2) In case of changing the Remote 'RUN' mode to 'STOP' by switch, operate the switch as follows.  
(STOP) → **RUN** → **STOP** .

Notes
<ol style="list-style-type: none"> <li>1) In case of changing Remote RUN mode to RUN mode by switch, PLC operation continues the operation without interruption.</li> <li>2) It is available to modify during RUN in RUN mode by switch but the mode change operation by XG5000 is limited. This should be set only in case that remote mode change is not allowed.</li> </ol>

### 5.4 Memory

There are two types of memory in CPU module that the user can use. One is Program Memory that saves the user program written by the user to build the system, and the other is Data Memory that provides the device area to save the data during operation.

#### 5.4.1 Program Memory

The configuration of user program memory is as below.

Items	Memory Capacity (Kbyte)							
	CPUUN	CPUHN	CPUSN	CPUU	CPUH	CPUA	CPUS	CPUE
Parameter Setting area : <ul style="list-style-type: none"> <li>• Basic parameter area</li> <li>• I/O parameter area</li> <li>• Special module parameter area</li> <li>• Communication module parameter area</li> <li>• User Event parameter area</li> <li>• Data Trace parameter area</li> </ul>	320	320	320	320			320	
Program Save area <ul style="list-style-type: none"> <li>• Scan Program area 1</li> <li>• Scan Program area 2</li> <li>• Variable/Explanation sentence area</li> </ul>	2,320	1,288	772	704			352	
System area <ul style="list-style-type: none"> <li>• User Event Data area</li> <li>• Data Trace Data area</li> <li>• System Log area</li> <li>• Device Backup area</li> </ul>	2,552	2,040	1,656	896			896	
Execution Program area <ul style="list-style-type: none"> <li>• Execution Program area1</li> <li>• Execution Program area2</li> <li>• System Program area</li> </ul>	4,096	2,048	1,024	2,048	1,024	512	512	256



5.4.2 Data Memory

1) Bit Device area

Various Bit Device are provided per function. The indication method is indicated by device type for first digit, word position by decimal for middle digit and bit position for the last digit.

Area per Device	Device features	Description
P00000 ~ P4095F	I/O device "P" 65,536 points	Image area to save the state of I/O device. After reading the input module state, saves it in the corresponding P area and sends P area Data saving the operation result to output module.
M00000 ~ M4095F	I/O device "M" 65,536 points	Internal Memory provided to save Bit Data in Program
L00000 ~ L11263F	I/O device "L" 180,224 points	Device to indicate high speed link/P2P service state information of communication module.
K00000 ~ K4095F	I/O device "K" 65,536 points	Device area to preserve the data during power shutdown, which is used without setting power shutdown preservation parameter separately.
F00000 ~ F4095F	I/O device "F" 65,536 points	System flag area that manages the flag necessary for system operation in PLC.
T0000 ~ T8191	I/O device "T" 8,192 points	Area to save the state of timer device
C0000 ~ C4095	I/O device "C" 4,096 points	Area to save the state of counter device
S00.00 ~ S255.99	Step controller "S" 256 x 100 steps	Relay for step control

Note

The following devices are limited to the area according to CPU type.

구분	P*** <sup>1</sup>	M*** <sup>2</sup>	K*** <sup>3</sup>	F*** <sup>4</sup>	T*** <sup>5</sup>	C*** <sup>6</sup>	S*** <sup>7</sup>
XGK-CPUE	P2047F	M2047F	K2047F	F2047F	T2047	C2047	S127.99
XGK-CPUS							
XGK-CPUA							
XGK-CPUH							
XGK-CPUU							
XGK-CPUSN	P4095F	M4095F	K4095F	F4095F	T8191	C4095	S255.99
XGK-CPUHN							
XGK-CPUU							
XGK-CPUUN							

## Chapter 5 Program Configuration and Operation Method

### 2) Word Device area

Area per Device	Device features	Description
D00000 ~ D524287 <sup>***1</sup>	Data Register "D" 524,288 words	Area to preserve the internal data. Bit expression possible.
R00000 ~ R32767	File Register "R" 32,768 words	Dedicated device to access Flash Memory. Consisted of 1,2,8,16 banks depending on the CPU Types Bit expression possible
U00.00 ~ U7F.31 <sup>***2</sup>	Analog Data Register "U" 4,096 words	Register used to read data from special module installed in the slot. Bit expression possible
N00000 ~ N21503	Communication Data Register "N" 21,504 words	P2P Service Save area of communication module. Bit expression impossible
Z000 ~ Z255	Index Register "Z" 256 words	Dedicated device to use Index function Bit expression impossible
T0000 ~ T8191	Timer Current Value Register "T" 8192 words	Area to indicate the current value of timer
C0000 ~ C4095	Counter Current Value Register "C" 4096 words	Area to indicate the current value of counter

#### Notes

The following devices are limited to the area according to CPU type.

구분	D <sup>***1</sup>	U <sup>***2</sup>	Z <sup>***3</sup>	T <sup>***4</sup>	C <sup>***5</sup>
XGK-CPUE	D19999	U1F.31	Z127	T2047	C2047
XGK-CPUS		U3F.31			
XGK-CPUA	D32767	U3F.31			
XGK-CPUH		U7F.31			
XGK-CPUU	D262143	U3F.31	Z255	T8191	C4095
XGK-CPUSN	D524287	U3F.31			
XGK-CPUHN		U7F.31			
XGK-CPUUN					

**5.5 Configuration Diagram of Data Memory**

**5.5.1 XGK-CPUE**

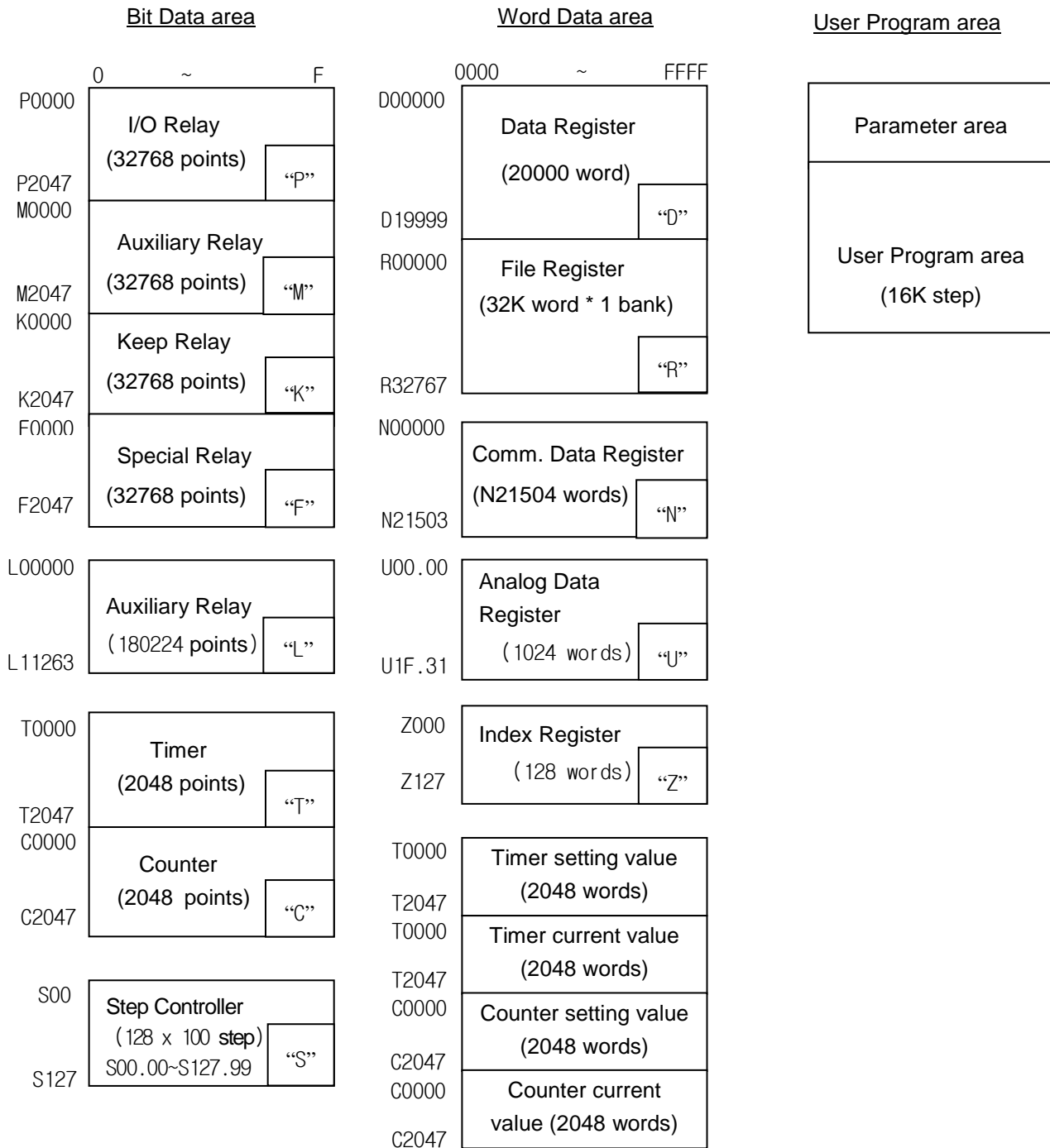

## 5.5.2 XGK-CPUS

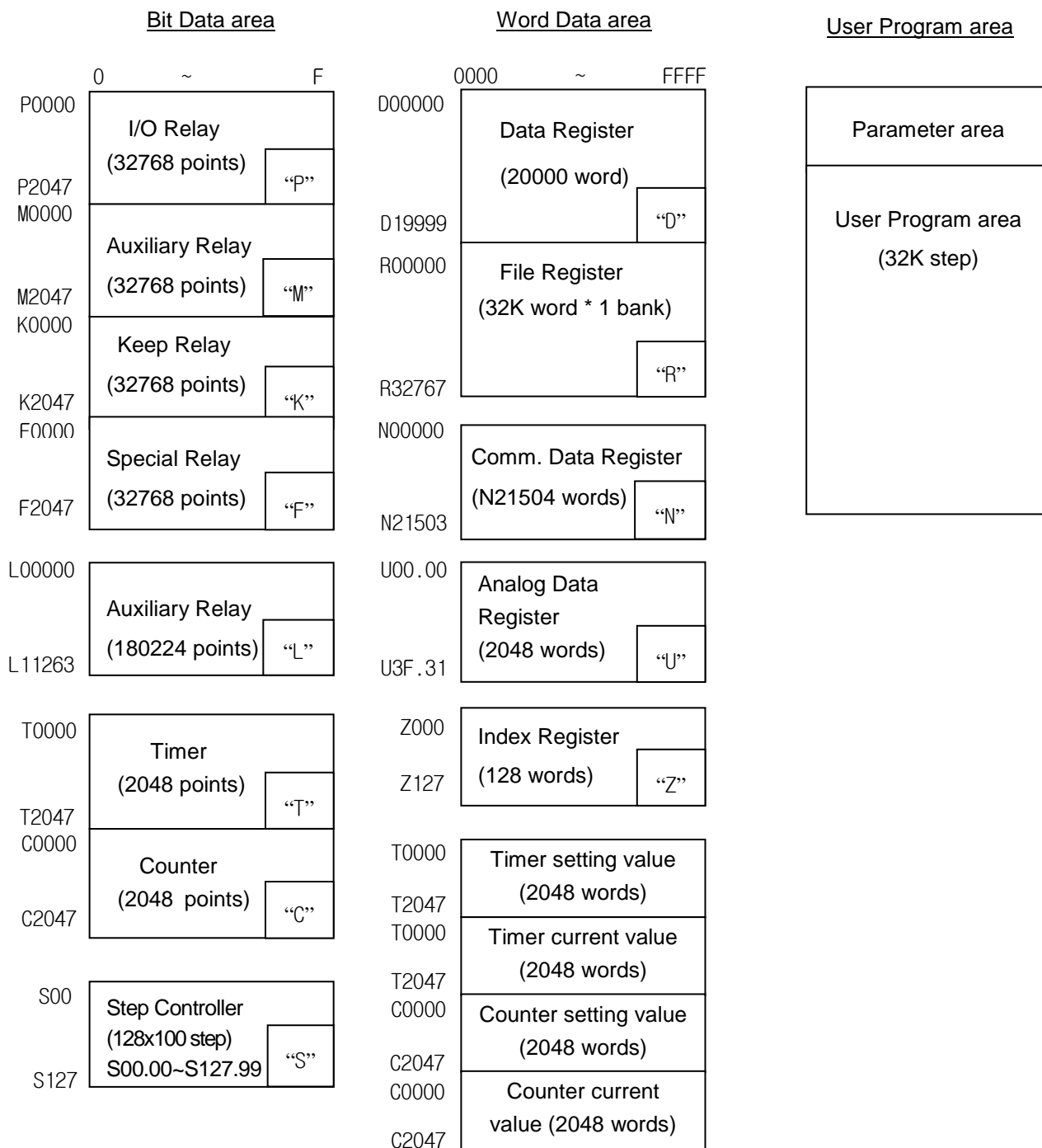

5.5.3 XGK-CPUA

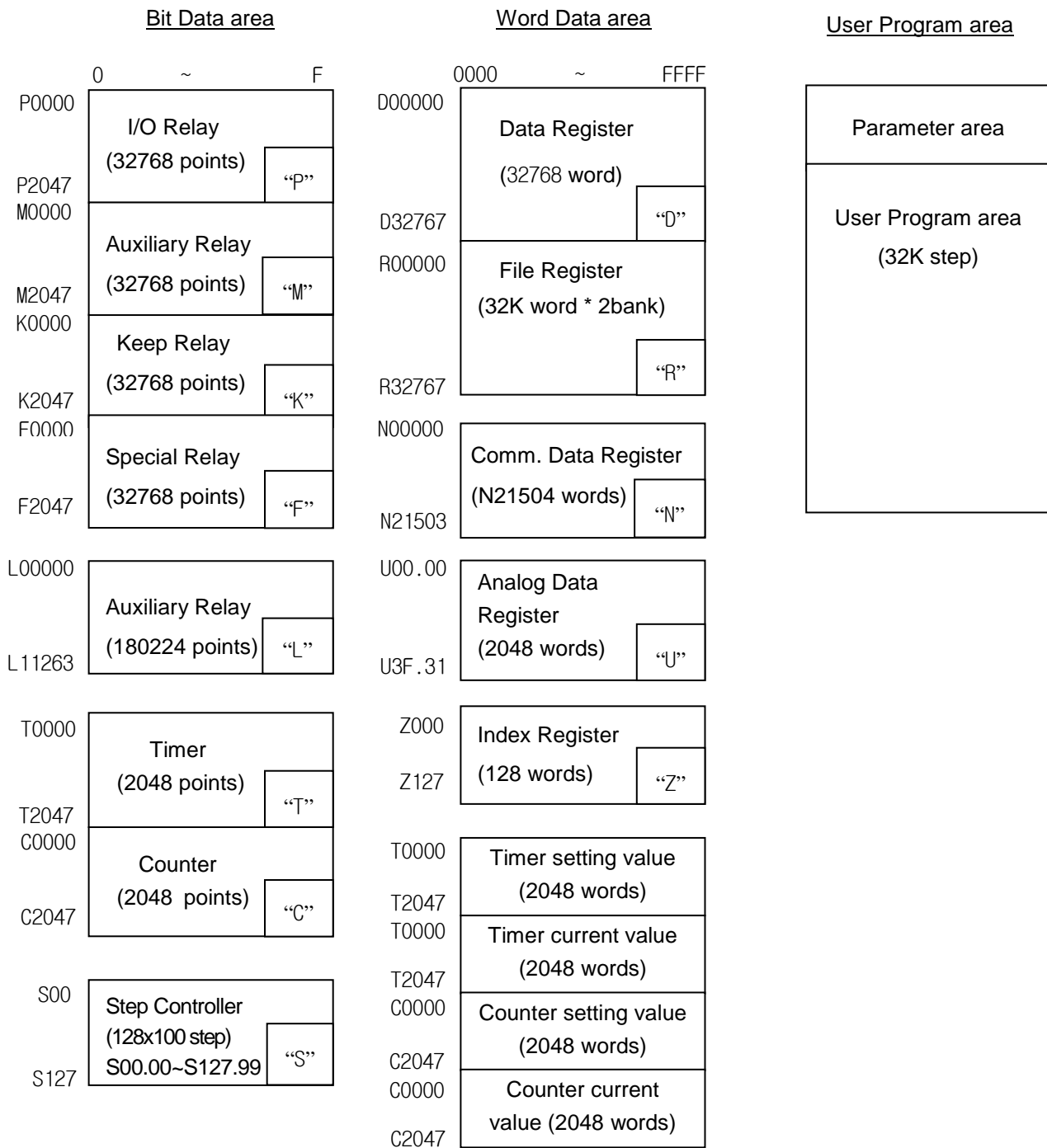

**5.5.4 XGK-CPUH**

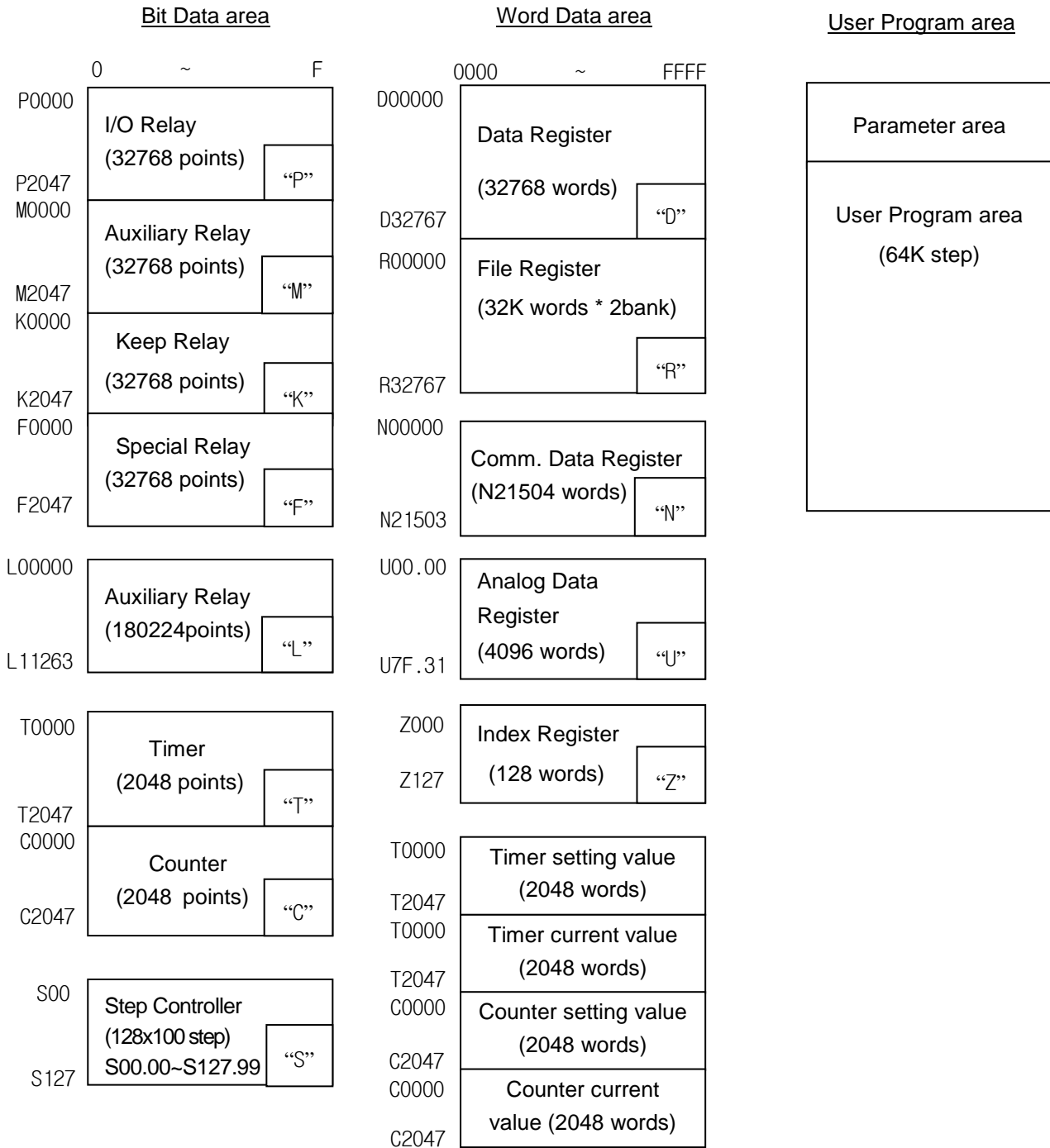

5.5.5 XGK-CPUU

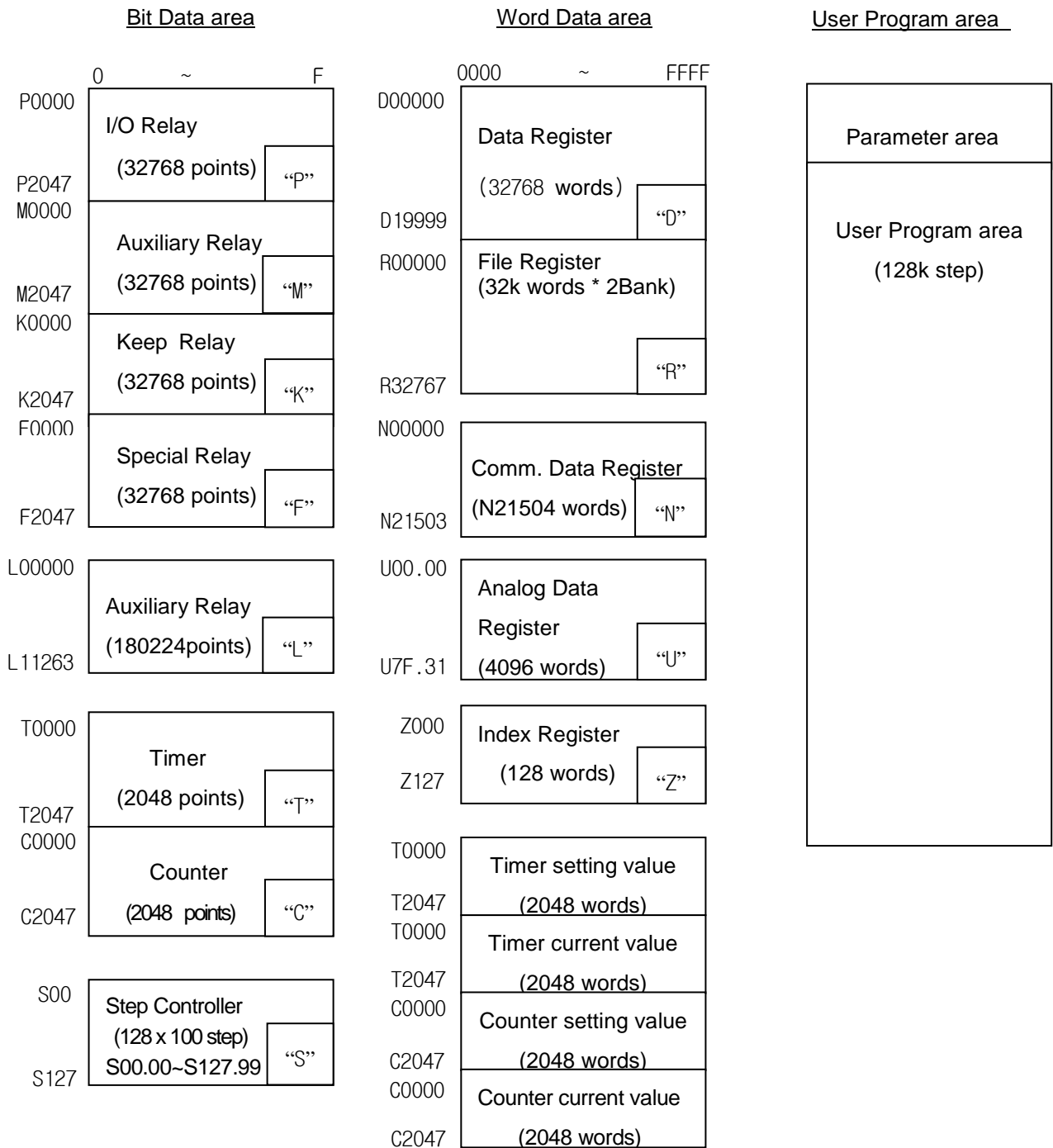

## 5.5.6 XGK-CPUSN

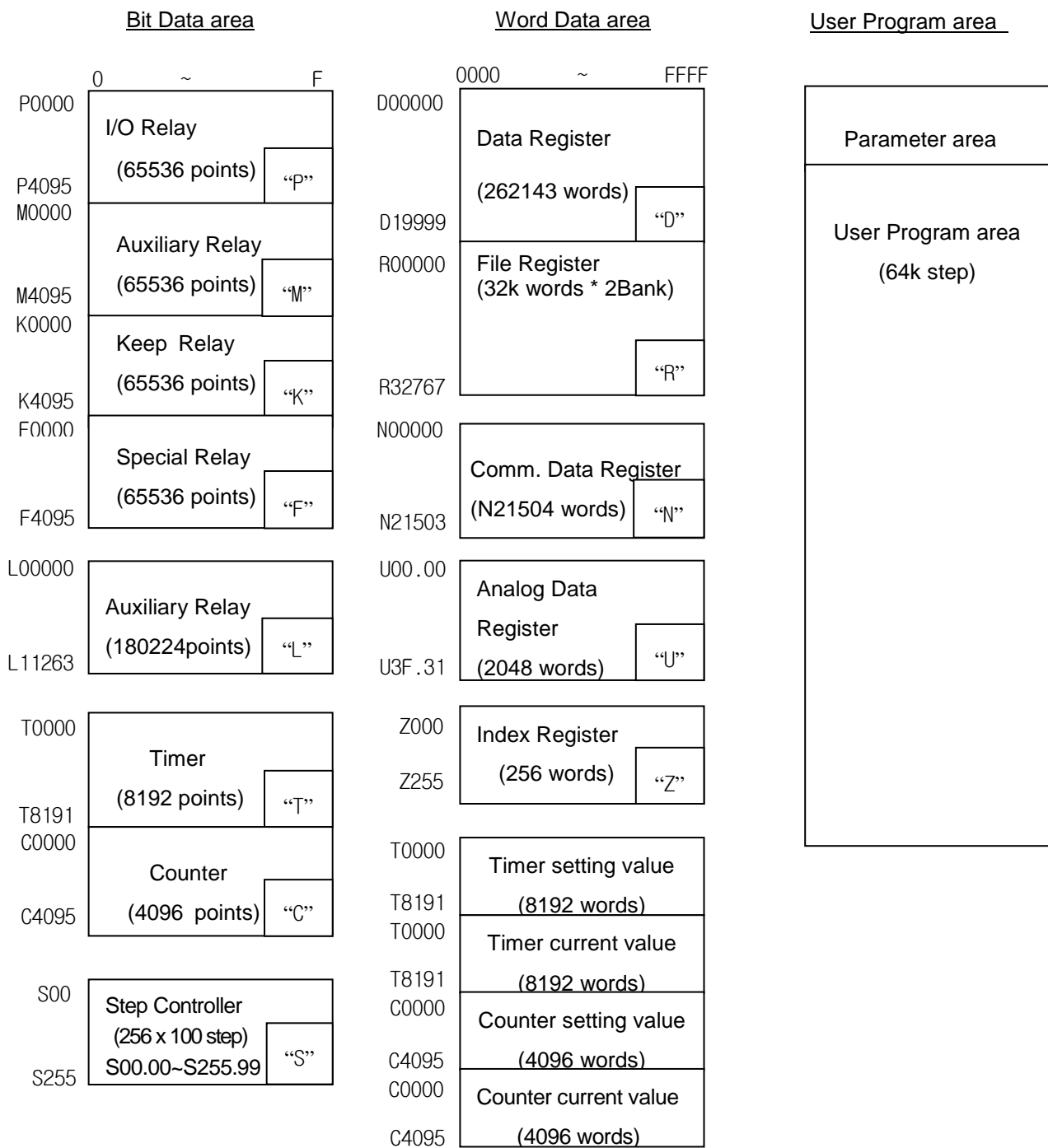



5.5.6 XGK-CPUHN

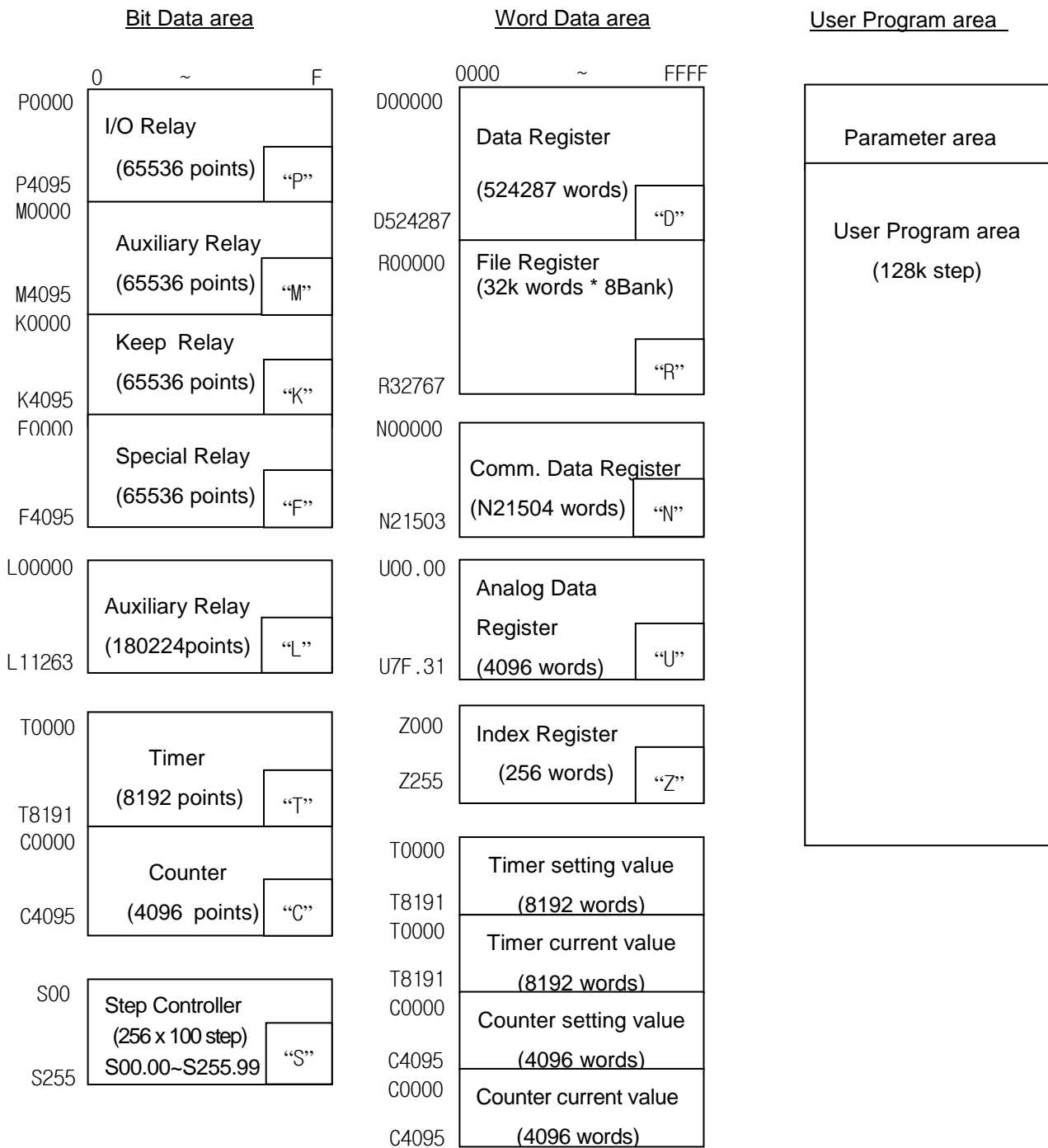

**5.5.6 XGK-CPUUN**

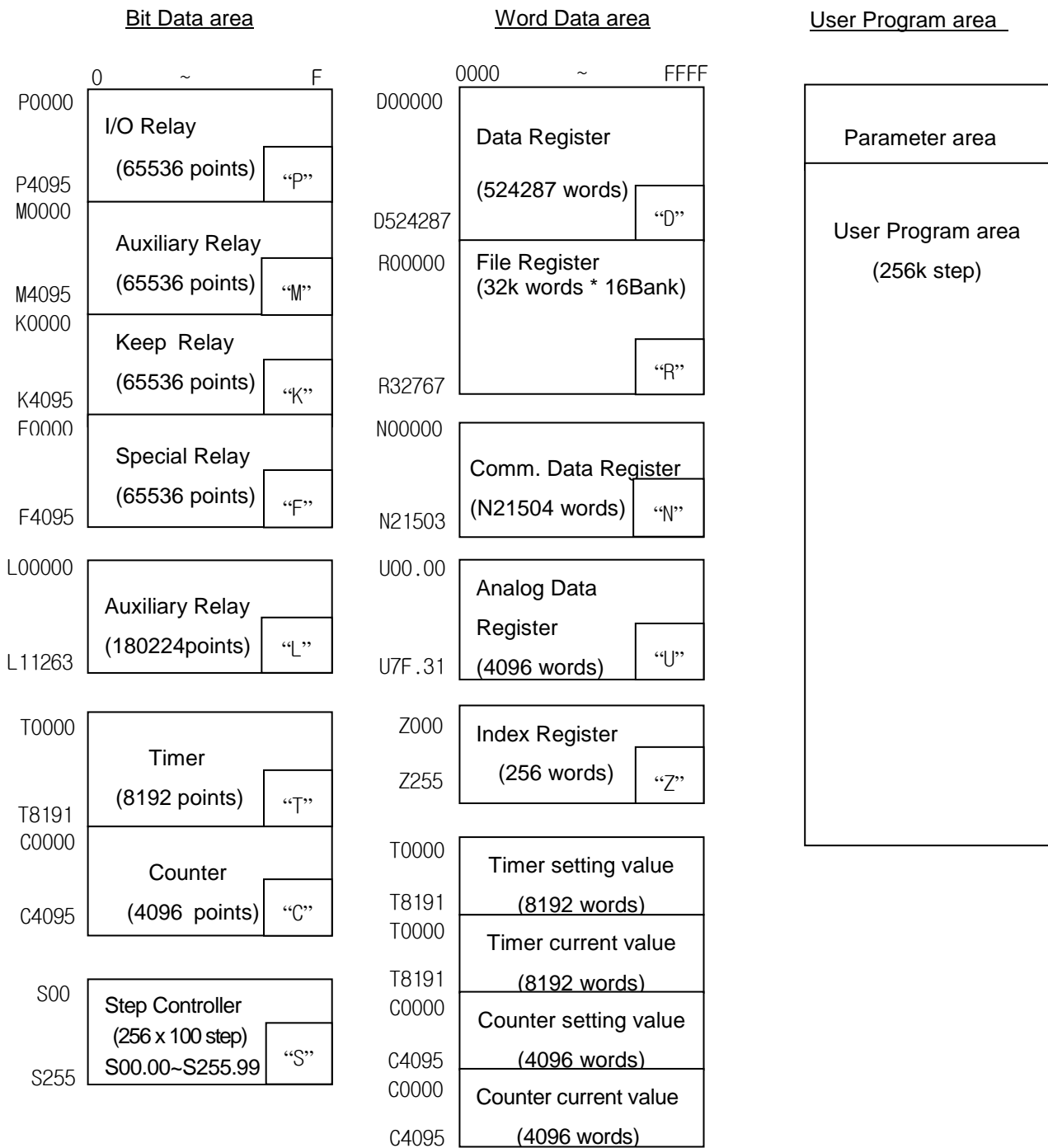

### 5.5.9 Data Latch Area Setting

When PLC stops and restarts the data required for operation or the data occurred during operation, if you want to keep and use those data, data latch can be used and it is available to use a certain area of some data device as latch area by parameter setting.

The below shows the features for latch device.

Device	1 <sup>st</sup> latch	2 <sup>nd</sup> latch	Features
P	X	X	Image area to save the state of I/O device
M	O	O	Internal device area
K	X	X	Device keeping the device state during power shutdown
F	X	X	System flag area
T	O	O	Timer related area (Bit/words both)
C	O	O	Counter related area (Bit/words both)
S	O	O	Relay for step control
D	O	O	General words data save area
U	X	X	Analog Data Register (latch disabled )
L	X	X	High speed link/P2P Service state device of communication module (latch enabled)
N	X	X	P2P Service address area of communication module (latch enabled)
Z	X	X	Index dedicated Register (latch disabled)
R	X	X	Flash memory dedicated area (latch enabled)

**Notes**

- 1) K, L, N, R devices are basically latched.
- 2) K, L, R devices operate like the 1<sup>st</sup> Latch that clears data by using Overall Reset or the CPU module D.CLR switch.
- 3) For more information, refer to the Online section of the XG 5000 user's manual.

## Chapter 5 Program Configuration and Operation Method

### 4) Data Latch Area Operation

The method to delete the latched data is as below.

- D.CLR switch operation of CPU module
- latch 1, latch 2 clear operation by XG5000
- write by Program (initialization program recommended)
- write '0' FILL from XG5000 monitor mode.

D.CLR Clear does not operate in RUN mode. Convert to STOP mode to operate. Also when clearing by D.CLR switch, bear in mind that general area shall be initialized.

When operating D.CLR momentarily, latch 1 area only shall be removed. If keeping D.CLR for 3 seconds, 6 LEDs shall be blinked and at this time, if returning the switch, even latch 2 area shall be cleared.

For keep or reset (clear) operation of latch area data according to PLC operation, please refer to the below table.

No.	Classification	Detailed operation	Latch 1	Latch 2	Remarks
1	Power change	Off/On	Keep	Keep	-
2	Reset switch	Reset	Keep	Keep	-
		Overall reset	Reset	Keep	-
3	D.CLR switch	Clear Latch 1	Reset	Keep	-
		Clear Latch 2	Reset	Reset	-
4	Program write (online)	-	Keep	Keep	-
5	Data broken	SRAM broken by battery error	Reset	Reset	-
		Data broken by other reason	Reset	Reset	-
6	XG5000 online	Clear Latch 1	Reset	Keep	-
		Clear Latch 2	Reset	Reset	-

### 5) Data Initialization

In case of Memory Delete state, the memory of all device shall be cleared as '0'. In case of giving the data value at the beginning according to system, please use the initialization task.

## Chapter 6 Functions of CPU Module

### 6.1 Self-diagnosis

- (1) Self-diagnosis function means the function that CPU module diagnoses the error of PLC system itself.
- (2) If the power of PLC system is applied or the error occurs during operation, it detects the error and prevents the abnormal operation.

#### 6.1.1 Scan Watchdog Timer

WDT (Watchdog Timer) is the function to detect the program congestion by the error of hardware and software of PLC CPU module.

- 1) WDT is the timer used to detect the operation delay by user program error. The detection time of WDT is set in Basic parameter of XG5000.
- 2) If WDT detects the excess of detection setting time while watching the elapsed time of scan during operation, it stops the operation of PLC immediately and makes the output all off.
- 3) If the excess of Scan Watchdog Time is expected in the program processing of specific part while performing the user program (FOR ~ NEXT instruction, CALL instruction), clear the timer by using 'WDT' instruction.  
'WDT' instruction initializes the elapsed time of Scan Watchdog Timer and starts the time measurement from 0 again.  
(For further information of WDT instruction, please refer to Instruction.)
- 4) To clear the error state of watchdog, we can use the following method : power re-supply, manipulation of manual reset switch, mode conversion to STOP mode.

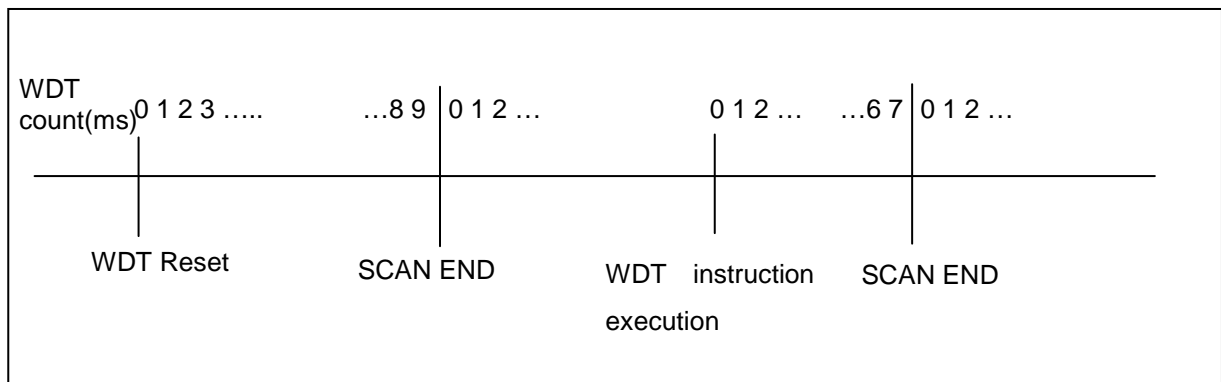

#### Notes

- 1) The setting range of Watchdog Timer is 10 ~ 1000ms (1ms unit).

### 6.1.2 I/O Module Check Function

This function is to check the error state of I/O module at the time of start or during operation.

- 1) In case that the module different from parameter setting is built-in at the time of start or it occurs the error  
or
- 2) In case I/O module is removed or occurs the error during operation,

the error state is detected and warning lamp (ERR) in front of CPU module and then CPU stops to operate.

### 6.1.3 Battery Voltage Check Function

If battery voltage falls less than memory backup voltage, CPU module detects it and informs of it. The warning lamp(BAT) in front of CPU module shall be ON.

For further information, please refer to “4.3.3 Durability of Battery”.

### 6.1.4 Error History Save Function

CPU module has the function that records the error history and analyzes the cause of the error to take a proper action if the error occurs. (Refer to 6.6.1 Error History)

This is the function to save each error code in special relay F0006.

#### Notes

All results of self-diagnosis shall be recorded in 'F' device area.

For further information of self-diagnosis comments and error actions, please refer to Chapter 12 Trouble shooting, 12.5 Error Code List.

### 6.1.5 Troubleshooting

#### 1) Classification of Error

The error occurs by PLC itself error, error in system configuration or error detection from operation results. The error is classified by heavy error mode that stops the operation for the system safety and light error mode that informs of the error occurrence warning to the user and continues the operation.

The error causes of PLC system is as follows.

- PLC hardware error
- Error in system configuration
- Operation error during user program proceeding
- Error detection by external device failure

#### 2) Action Mode in case that Error Occurs

If error occurs, PLC system records the error comments in flag and stops to operate or continues the operation according to error mode.

(1) PLC hardware error

In case of heavy error that the normal operation of PLC such as CPU module, power module is disabled, the system 'stop's and in case of light error such as battery error, it continues to operate.

(2) Error in system configuration

This error occurs when hardware configuration of PLC is different from the configuration identified in software, and the system stops.

(3) Operation Error during User Program Proceeding

This is the error occurred during user program proceeding and in case of numeric operation error, it is indicated in the error flag and the system continues to operate. While performing the operation, if the operation time exceeds the scan watchdog time or the built-in I/O module can not be controlled normally, the system stops.

**Notes**

- 1) The operation process is determined by selecting 'Basic Parameters → Error Operation Setup → Continue running when an arithmetic error occurs'.
- 2) The default is set to 'Continue running when an arithmetic error occurs'.

(4) Error detection by external device error

This is to detect the error of external control device by PLC user program. In case of heavy error, the system stops but in case of light error, the system indicates the error state only and continues to operate.

**Notes**

- 1) If the error occurs, the error codes are saved in special relay F1026.
- 2) The error code is saved in F1027 when a soft-fault is detected.
- 3) For further information on the Flag, please refer to Appendix 1 Flag List.

### 6.2 Clock

CPU module has a built-in clock device (RTC). RTC continues the clock action by battery backup even in case of power off or instantaneous interruption.

It is available to perform the time management such as operation history or failure history of system by using a clock data of RTC. The current time of RTC can be updated in F device related to the clock every scan.

#### 1) Read and Setting from XG5000

Click 'PLC RTC' from 'PLC information' of online mode.

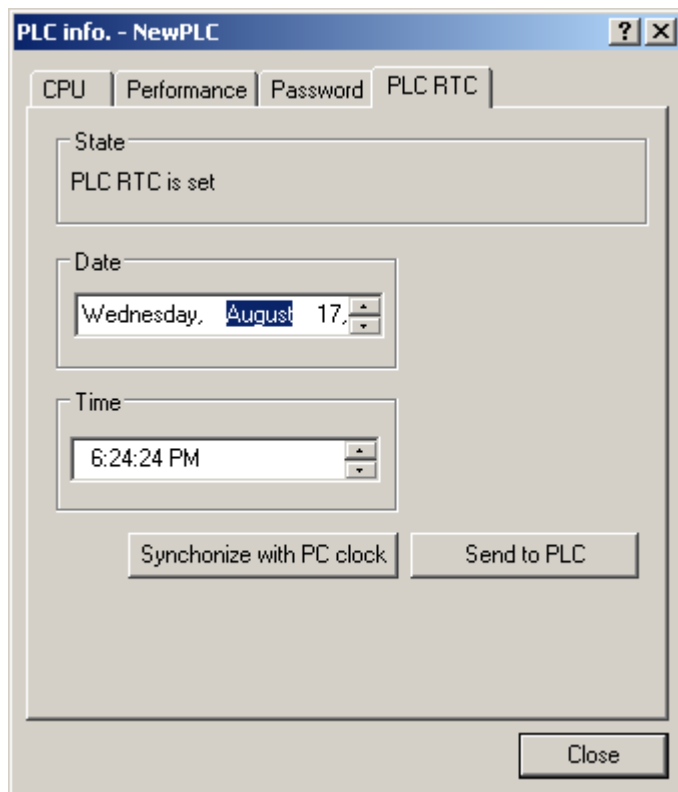

The time of PLC RTC is displayed. If the time of PLC RTC is wrong, you can adjust the time correct by setting the time directly to transmit to PLC or selecting 'Synchronize with PC clock' that transmits the time of PC connected to PLC.

#### 2) RTC Read by Device

It is available to monitor RTC by special device as shown on the table below.

RTC Read F device	Data example	Description
_MON_YEAR (F0053)	h0599	May xx99
_TIME_DAY (F0054)	h1512	12(day), 15 (time)
_SEC_MIN (F0055)	h4142	42min 41sec
_HUND_WK (F0056)	h2001	Monday 20xx

RTC Data of \_TIME\_DAY\_DT is displayed by 24hours system.



### 3) RTC Data Modification by Program

It is available for the user to set the RTC value by program.

This function is used when setting the time manually through external Digit switch or making the system that corrects the time periodically through network.

'DATEWR' instruction is to insert the setting value in the F area device below and write the time to RTC at scan END.

RTC write F device	Comments	Setting range
_MON_YEAR_DT (F1034)	Month/Year	1984 ~ 2163 Year, Jan.~ Dec.
_TIME_DAY_DT (F1035)	Time/Day	1~31 Days, 0~23 Hour
_SEC_MIN_DT (F1036)	Second/Minute	0~59 minute, 0~59 second
_HUND_WK_DT (F1037)	100years/Weekday	0 ~ 6

It is available to write the data to RTC without using a instruction, by writing the RTC data to the above area and making '\_RTC\_WR (F10240)' to be 'On'.

- In case that time data does not match with the form, the value is not allowed to write.  
(But if the week does not match, it shall be set as it is without error detection.)
- Monitor the RTC read device after writing RTC data, and check if it is modified correctly.

### 4) Weekday Expression Method

No.	0	1	2	3	4	5	6
Day	Sunday	Monday	Tuesday	Wednesday	Thursday	Friday	Saturday

### 5) Time Tolerance

RTC tolerance depends on ambient temperature. Time tolerance according to temperature per day was indicated on the table as below.

Operation temperature	Max. tolerance (second/day)	Normal case (second/day)
0 °C	- 4.67 ~ 1.38	-1.46
25 °C	- 1.64 ~ 2.42	0.43
55 °C	- 5.79 ~ 0.78	-2.29

#### Note

- 1) RTC may not have the clock data written at first.
- 2) When using a CPU module, you must set the clock data correctly at first.
- 3) In case that the data out of range of clock data is written in RTC, it may not work normally.  
Ex) 14Month 32Day 25Hour
- 4) RTC may stop or occur error because of battery error. If new clock data is written in RTC, the error shall be cleared.
- 5) For more information about the time date modification by program, refer to the XGK *Instructions* user's manual.

### 6.3 Remote Function

CPU module enables to change the operation by communication except key switch mounted in the module. If you want to operate it by Remote, you should set 'REM enable' switch (4-pin deep) of CPU module as 'ON' position and 'RUN/STOP' switch as 'STOP' position.

#### 1) Type of Remote Operation

- (1) Operated by connecting XG5000 through USB or RS-232 port mounted in CPU module.
- (2) Available to operate other PLC connected to the network of PLC in the state that XG5000 is connected to CPU module.
- (3) Controls the operation state of PLC by MMI software through dedicated communication

#### 2) Remote RUN/STOP

- (1) Remote RUN/STOP performs RUN/STOP when the deep switch of the CPU module is in the REMOTE position and the RUN/STOP switch is in the STOP position.
- (2) Convenient function in case that CPU module is installed in the position difficult to operate or CPU module inside control panel is controlled by RUN/STOP from outside.

#### 3) Remote DEBUG

- (1) Remote DEBUG is the function to perform DEBUG operation in the state that Deep switch of CPU module is in REMOTE position and the RUN/STOP switch is in the STOP position. DEBUG operation means the function performed according to the operation condition assigned for program operation.
- (2) Convenient function in case of checking the execution state of program or the contents of each data from Debugging work

#### 4) Remote Reset

- (1) Remote Reset is the function to reset a CPU module by remote operation in case that the error occurs in the place not possible to operate a CPU module.
- (2) This supports 'Reset' and "Overall Reset" as like an operation by switch.

#### Notes

- 1) For operation method of Remote Function, please refer to 'Online' part from XG5000 user's manual.

#### 5) Flash memory operation of PLC

- (1) When PLC operation mode Changes to Run, it executes Run operation after copying the program in the flash memory to the program memory. In other words, it runs PLC through the program in the flash memory.  
(PLC operation in Run mode: it means that the operation mode changes from Stop to Run, and that the operation mode is Run when PLC is powered back on)

(2) Flash memory operation mode setting

Online → Set Flash Memory → Check the 'Enable flash memory operation mode' → Click OK

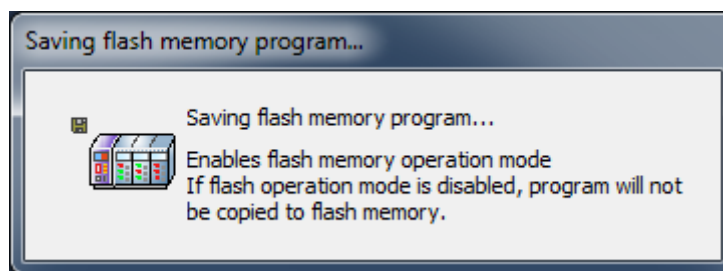
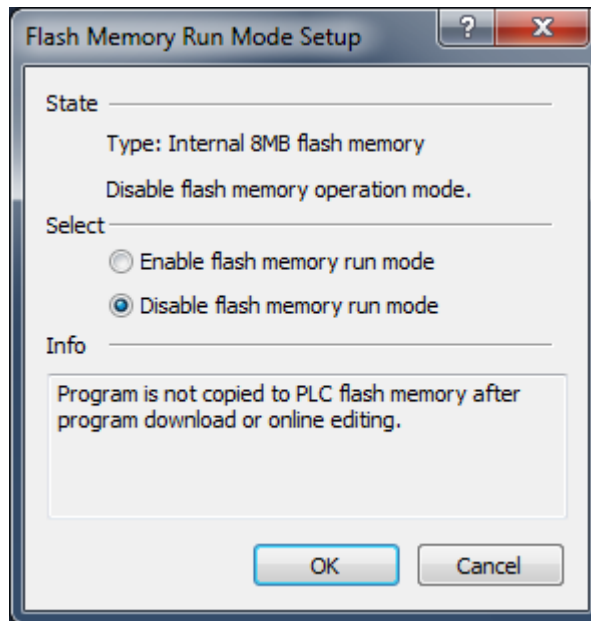

### Notes

- 1) Initial mode is Disable flash memory run mode
- 2) Set Enable flash memory run mode at once, it keeps the mode On until the PADT is Off
- 3) Change of the flash memory operation mode is available regardless of RUN/STOP Mode
- 4) Make sure that the program write to the flash memory completely when you try 'modification during run' in flash memory operation mode. If it can't be written completely, the program you write before will be carried out.
- 5) When you set the flash memory operation mode, it is necessary that flash memory programming is completed, the flash memory operation mode is applied. If you restart the PLC before program writing is completed, "flash memory operation mode" will be canceled.

## Chapter 6 Function of CPU Module

### (3) Flash memory operation method

If you want to change the restart or operation mode the PLC system to RUN, depending on the setting of the flash operation mode, it works as follows.

Set of flash memory operation mode	Operation contents
ON	Or different contents of the flash memory and program memory, if the contents of the reasons the program memory such as a decrease in the battery voltage is damaged, then operation after downloading the program stored in the flash memory to program memory.
OFF	CPU runs at a program that is recognized as programmed into the flash memory does not exist are stored in on-chip RAM.

### (4) The saving data in flash memory mode

CPU Mode	Saving data
Run	Local Ethernet Parameter
	Communication Parameter
Stop	Program
	Basic Parameter
	Local Ethernet Parameter
	Communication Parameter
	Special module Parameter
	Auto Variable
Modification During Run	Comments
	Program
	Auto Variable
	Comments

## 6.4 Forced I/O On/Off Function

Forced I/O function is used to force I/O area ON/OFF regardless of the result of program execution.

### 6.4.1 Forced I/O Setup Method

Click 'Forced I/O setup' in online mode.

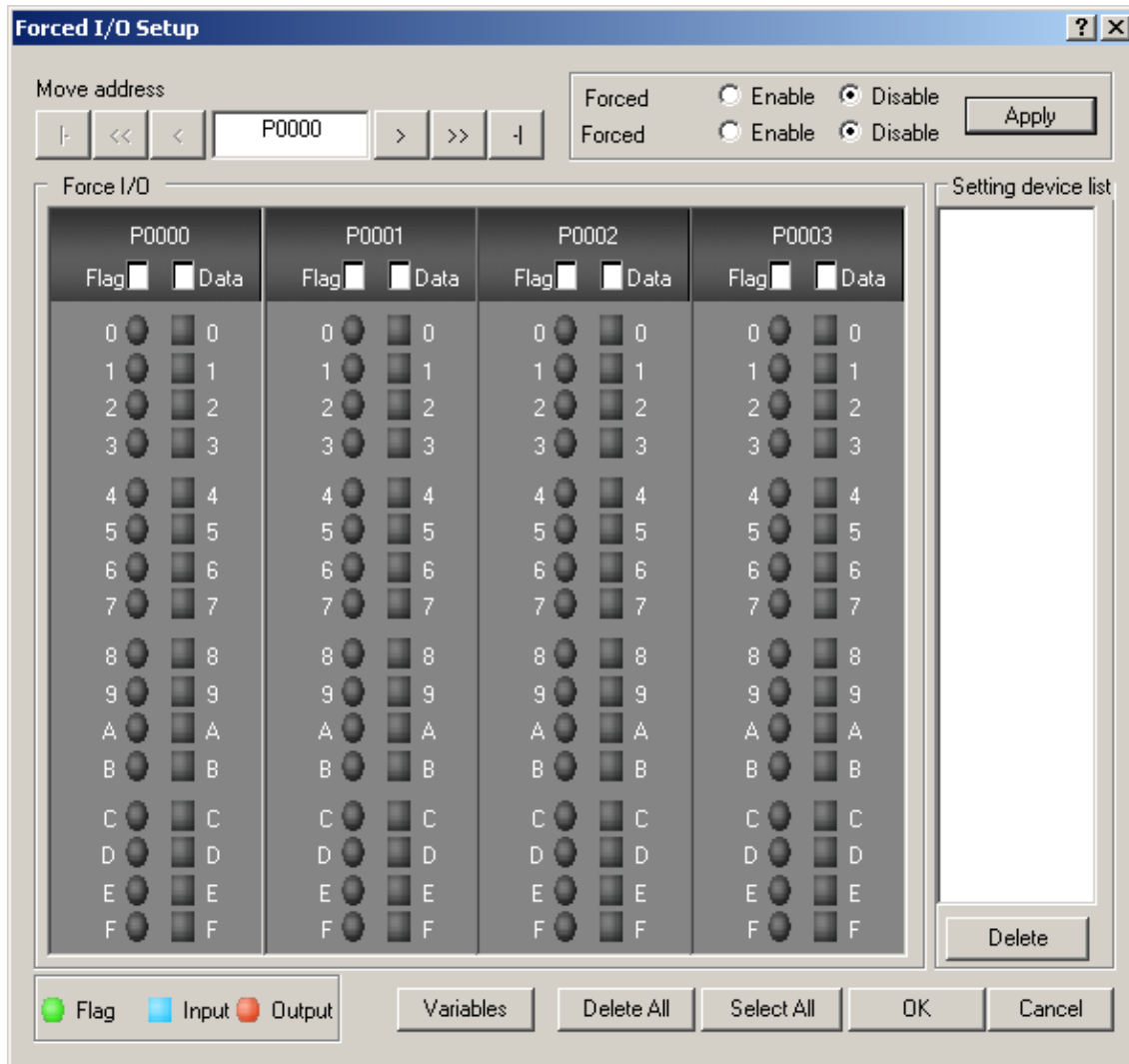

To set Forced I/O, select the proper flag and data check box of P device.

To set the value "1", select the correspond bit data and flag.

To set the value "0", select the flag only not bit data.

The setting is applied when forced input or output is enabled.

For further information of setting method, please refer to the XG5000 user's manual.

#### Notes

- 1) The Forced I/O setting is only available for the local I/O module.
- 2) It is not available for the remote I/O module (Smart I/O module).
- 3) The PS LED is turned On if Forced I/O is selected.

### 6.4.2 Forced On/Off Execution Point and Execution Method

#### (1) Forced Input

Input replaces the data of contact point set as forced On/Off from the data read in input module at the time of input refresh with the forced setting data and updates the input image area. Therefore, the user program operates with actual input data while the forced setting area operates with forced setting data.

#### (2) Forced Output

Output replaces the data of contact point set as forced On/Off from the data of output image area having the operation result, at the time of output refresh after completion of user program operation execution, with the forced setting data and makes prints in output module. In case of output other than input, the data of output image area does not change by forced On/Off setting.

#### (3) Notices in using forced I/O function

- It operates from the point setting 'enable' of each input/output, after setting the forced data.
- It is available to set the forced input even if actual I/O module is not built-in.
- Even if there are power Off -> On, change of operation mode or operation by reset key, On/Off setting data set in before is kept in CPU module.
- Forced I/O data shall not be cleared even in Stop mode.
- If you want to set the new data from the beginning, clear all settings by using 'Delete all' before using.

## 6.5 Direct I/O Operation

By making Refresh for I/O contact point with using 'IORF' instruction, it enables to read the state of input contact point directly during program execution and use it for operation, and also this is used when printing out the result of operation directly in output contact point.

#### Notes

- 1) For further information of IORF instructions, please refer to XGK Instruction manual.
- 2) If IORF instruction is used, the value is applied immediately, and it is used prior to Forced I/O.

### 6.6 Saving Operation History

For operation history, there are 4 types such as error history, mode conversion history, power shutdown history and system history.

The time, numbers and operation contents that each event occurred, are saved in the memory and is monitored conveniently through XG5000.

Operation history is kept saving in PLC unless it is deleted by XG5000 etc.

#### 6.6.1 Error History

This saves the error history occurred during operation.

- Saves the error code, date, time, error detailed contents etc.
- Saves up to max. 2048
- Automatic release in case that memory backup is broken by battery voltage falling etc.

#### 6.6.2 Mode Conversion History

This saves the changed mode information and time in case of operation mode change.

- Saves the date, time, mode conversion contents
- Saves up to max. 1024

#### 6.6.3 Power Shutdown History

This saves the time that the power is ON or OFF with ON/OFF information.

- Saves ON/OFF information, date, time
- Saves up to max. 1024

#### 6.6.4 System History

This saves the operation history of system occurred during operation.

- Saves the date, time and operation change contents
- XG5000 operation information, key switch change information
- Saves up to max. 2048

## Chapter 6 Function of CPU Module

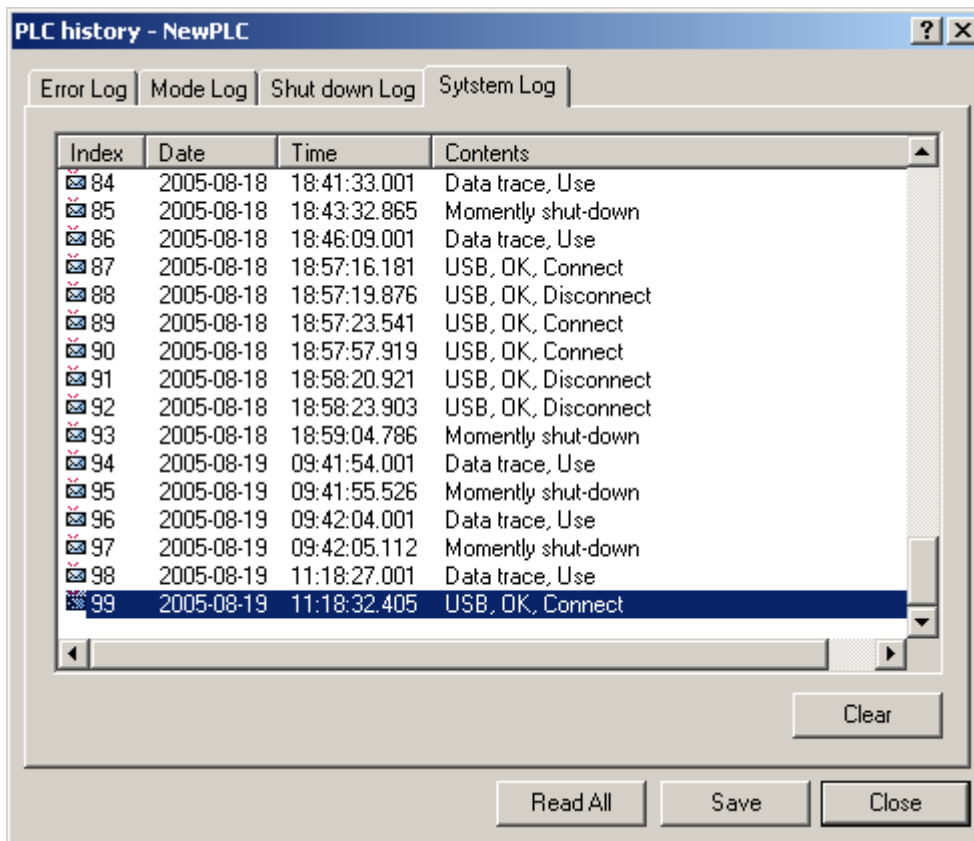

### Notes

- 1) The saved information will not be deleted before selecting the menu from XG5000 to delete.
- 2) If the index number saved is over 100, select Read All to check previous history.



## 6.7 External Device Error Diagnosis

This is the flag provided so that the user can detect the error of external device and realize the stop and warning of system easily. By using this flag, it enables to indicate the error of external device without preparing the complicated program and monitor the error position without special device (XG5000) or source program.

### 1) Detection and classification of external device error

(1) The error of external device is detected by the user program and classified by heavy error that needs to stop the PLC operation and light error (warning) that continues the PLC operation and only indicates the error state, according to the contents of detected error.

(2) For heavy error, ‘\_ANC\_ERR flag’ is used and for light error, ‘\_ANC\_WAR flag’ is used.

### 2) Treatment of heavy error of external device

(1) In case that heavy error of external device is detected in the user program, classify the type of error defined by the user and write the value except ‘0’ in the system flag ‘\_ANC\_ERR’, and set system flag ‘\_CHK\_ANC\_ERR’. System representative error flag ‘\_ANNUN\_ER’ of ‘\_CNF\_ER’ is set, PLC shall shut off all output module and becomes the error state same as PLC own error detection.

(2) If the error occurs, the user can find the cause of error by using a XG5000 or by monitoring ‘\_ANC\_ERR flag’.

(3) It is available to write the error code assigned temporarily by the user at \_ANC\_ERR and the available numbers are from 1 to 65,535.

#### ■ Example

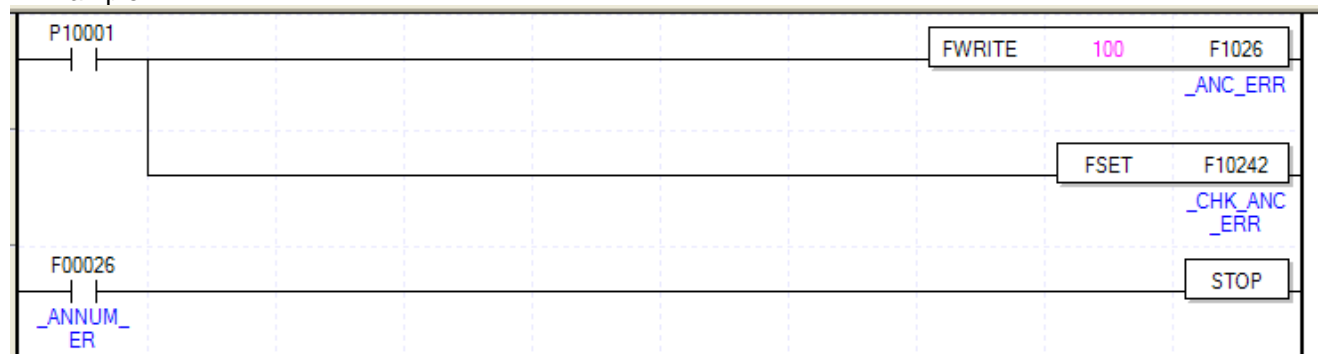

### 3) Treatment of light error of external device

(1) In case that heavy error is detected in the user program, classify the type of error defined by the user and write the value except ‘0’ in the system flag ‘\_ANC\_WAR’, and set system flag ‘\_CHK\_ANC\_WAR’. Then, system representative error flag ‘\_ANNUN\_WAR’ of ‘\_CNF\_WAR’ is set and light error code of external device is saved at \_ANC\_WAR.

(2) If the error occurs, the user can find the cause of error by monitoring ‘\_ANC\_WAR’ flag directly.

(3) If the light error of external device is released, ‘\_ANC\_WAR’ will be released after user program is executed and system flag ‘\_ANNUN\_WAR’ of ‘\_CNF\_WAR’ will be reset.

## Chapter 6 Function of CPU Module

### ■ Example

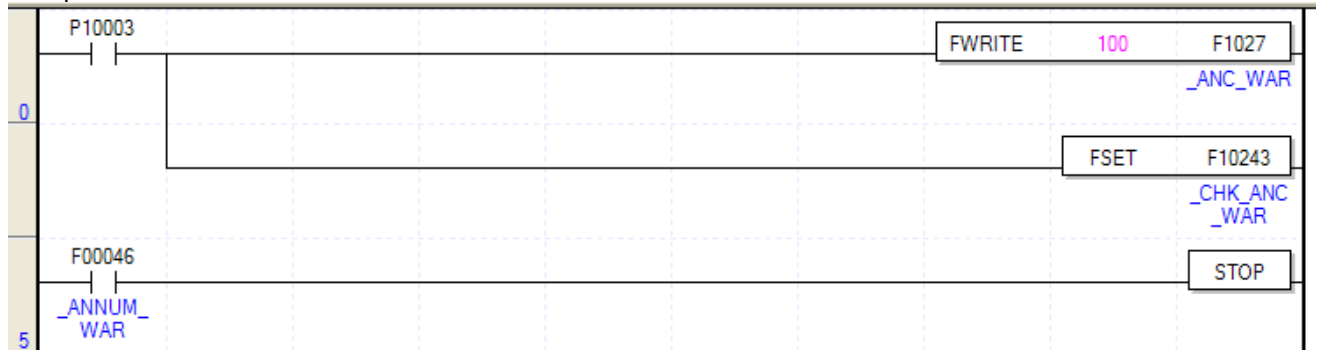

If P10003 is on, inputs '100' at '\_ANC\_WAR' and sets system flag '\_CHK\_ANC\_WAR'. And '\_ANNUM\_WAR' is set and stops PLC.

### 6.8 Fault Mask

#### 1) Purpose and Operation Overview

- Fault Mask is the function to continue the program execution even if the module error occurs during operation. The module assigned as Fault Mask shall be operated normally before error occurs.
- If the error occurs in the module where the Fault Mask is set, the corresponding module stops the operation but the whole system continues the operation.
- If the module error occurs during operation, CPU module will set the error flag and the front “PS LED” shall be “ON”. If connecting XG5000, you can see the error state.

#### 2) Fault Mask Setting Method

- The Fault Mask Setting is available on the online menu of XG5000. For further information, please refer to XG5000 user's manual.
- The Fault Mask Setting is also available by setting the Fault Mask flag by program. (Please refer to Appendix 1 Flag List.)

#### 3) Release of Fault Mask

The Fault Mask is released only by the same method as the setting.

- Setting release from online menu of XG5000.
- Automatic release in case that memory backup is broken by battery voltage falling.

The Fault Mask shall not be released in the following cases. Cares should be taken.

- Power Off → On
- Change of operation mode
- Program download
- Operation of reset key
- Data clear

#### Notes

- 1) If releasing the Fault Mask in the state that error flag of CPU module is not deleted even if the cause of error occurrence is removed, the system stops. Before releasing the Fault Mask flag, check the state of error flag.

### 6.9 I/O Module Skip

#### 1) Purpose and Operation Overview

This is the function to exclude the module assigned during operation, from operation. For the assigned module, it is disabled to update I/O data or diagnose the error from the assigned moment. It is allowed to use only in case of temporary operation excluding the error part.

#### 2) Setting Method and I/O Data Processing

- It is available to set by I/O module unit.  
(For further information, please refer to XG5000 user's manual.)
- As Input(I) image area stops input refresh, it keeps the value before skip setting. But, at this time, it is effective to operate the image by forced On/Off.
- Actual output of output module shall be OFF in case of skip setting but output(Q) image area is changed according to the user program operation regardless of skip setting. It is not allowed to operate output value of output module by forced On/Off after skip setting.
- The execution of skip function when using direct I/O function is same.

#### 3) Release of Skip Function

The skip of I/O module shall be released only by the same method as setting.

- Setting release from online menu of XG5000
- Automatic release in case the memory backup is broken by battery voltage falling

The Fault Mask shall be released even in the cases as below. Cares should be taken.

- Power Off→On
- Change of operation mode
- Program download
- Operation of reset key
- Data clear

#### Notes

- 1) When releasing a skip, if the error occurs in the corresponding module, the system may stop. Release the skip in the state that the Fault Mask is set and check the normal operation of module before releasing the skip.

### 6.10 Changing Module during Operation

XGK system enables to change the module during operation. But, as the change of module during operation may occur the abnormal operation of whole system, special attention should be taken. Just follow the procedure assigned in this user's manual.

#### 1) Notices in Using

- Not allowed to change the base and power module.
- Some part of communication module (XGL-PMEA, XGL-DMEA) needs the network setting (Sycon used) for communication.
- In case of module change, match the joint part of the lower part of base and module correctly before inserting. If not, it may cause the system shutdown.

#### 2) Module Change Method

There are 2 kinds of module change method.

(1) By using XG5000 "Module Change Wizard" function.

For further information, please refer to XG5000 user's manual.

(2) By using CPU module switch

- (1) Set "Module change switch (M.XCHG)" in front of CPU module as right(ON).
- (2) Remove the module. (PS LED is ON)
- (3) Setup the new module. (in case of normal module setup, PS LED is OFF)
- (4) Check if module operates normally.
- (5) Set "Module change switch (M.XCHG)" as left (OFF).

#### Notes

- 1) When changing the module, shut down the load power for safety.
- 2) When changing the input module, consider the setting of input image state by using the forced On/Off.

#### Warning

When installing the module, it may cause an abnormal operation if the lower connection is not mounted on the base completely.

### 6.11 I/O No. Allocation Method

The allocation of I/O No. is to give the address to the I/O terminal of each module in order to read the data from input module and print the data to output module when performing the operation.

For I/O No. allocation, base no., slot position, module type for setup and parameter setting etc. are related. XGK provides 2 types such as fixed and variable.

#### 6.11.1 Fixed I/O No. Allocation

By selecting “Assign fixed points to I/O slot” from basic parameter, 64 points shall be allocated to each slot regardless of setup module. In this case, I/O parameter shall be applied only to judge whether the module type installed in the system corresponds, but not applied to point allocation.

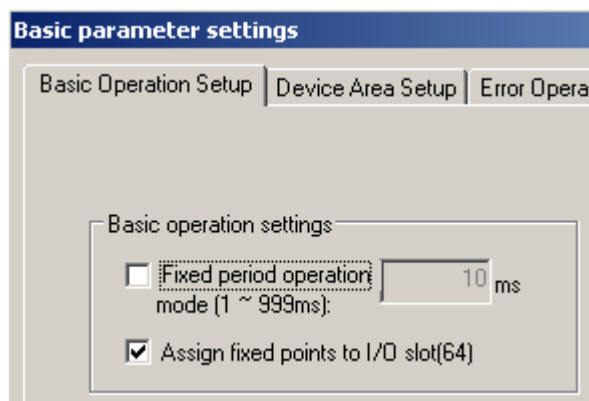

For example of point allocation, please refer to “2.3 Basic System”.

#### 6.11.2 Variable I/O No. Allocation

By releasing “Assign fixed points to I/O slot” from basic parameter, the variable type that the point allocation is changed per slot shall be set.

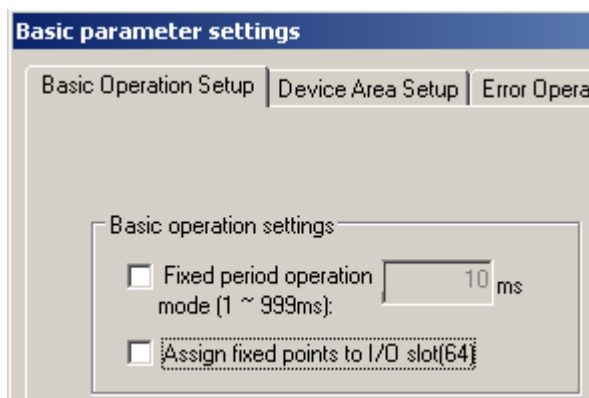

If setting I/O parameter, the point related to the setting module shall be given to the assigned slot. For the next slot, the number following I/O no. occupied by the previous slot shall be allocated.

For example of point allocation, please refer to “2.3 Basic System”.

### 6.11.3 Module Reservation Function

This function is used for the variable I/O number allocation method to reserve modules to be mounted. If this function is used, the program modification is not necessary to change the I/O number. It can be set in the I/O Parameters window of XG5000.

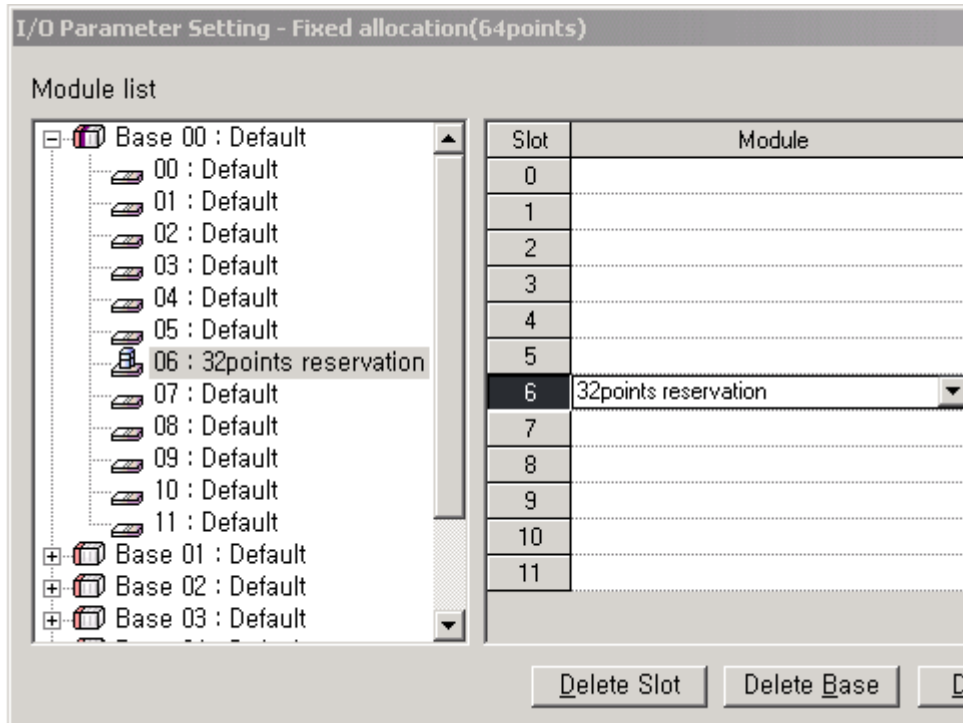

#### Notes

- 1) If a module greater than 16-point is mounted on without reservation, the I/O number will become different and an abnormal operation will occur.
- 2) Only reserved points are available although larger point modules are mounted. The remainder are ignored.
- 3) Program modification is not necessary because all slots are assigned as 64points in Fixed Allocation.

## 6.12 Program Modification during Operation

It is available to modify program or some parameter without stopping the control operation during PLC operation. For further information, please refer to XG5000 user's manual.

The items available to modify during operation are as below.

- Program modification
- Communication parameter modification

## Chapter 6 Function of CPU Module

### 6.13 Local Ethernet function(XGK-CPUUN/CPUHN/CPUSN)

XGK-CPUUN/CPUHN/CPUSN can carry out the functions of Ethernet server using internal local Ethernet function without extra Enet I/F module.(Note, The internal local Ethernet doesn't offer remote connections. Only used for local connection.)

#### 6.13.1 Local Ethernet Parameter Settings.

Make a new project. Then user can see Local Ethernet Parameters as shown below figure.

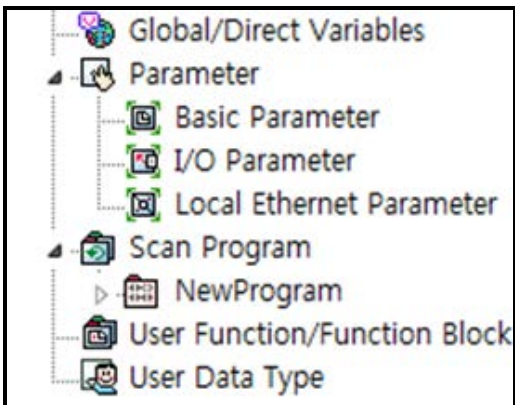

If user selects Local Ethernet Parameter item, Local Ethernet Parameter setting window will be displayed.

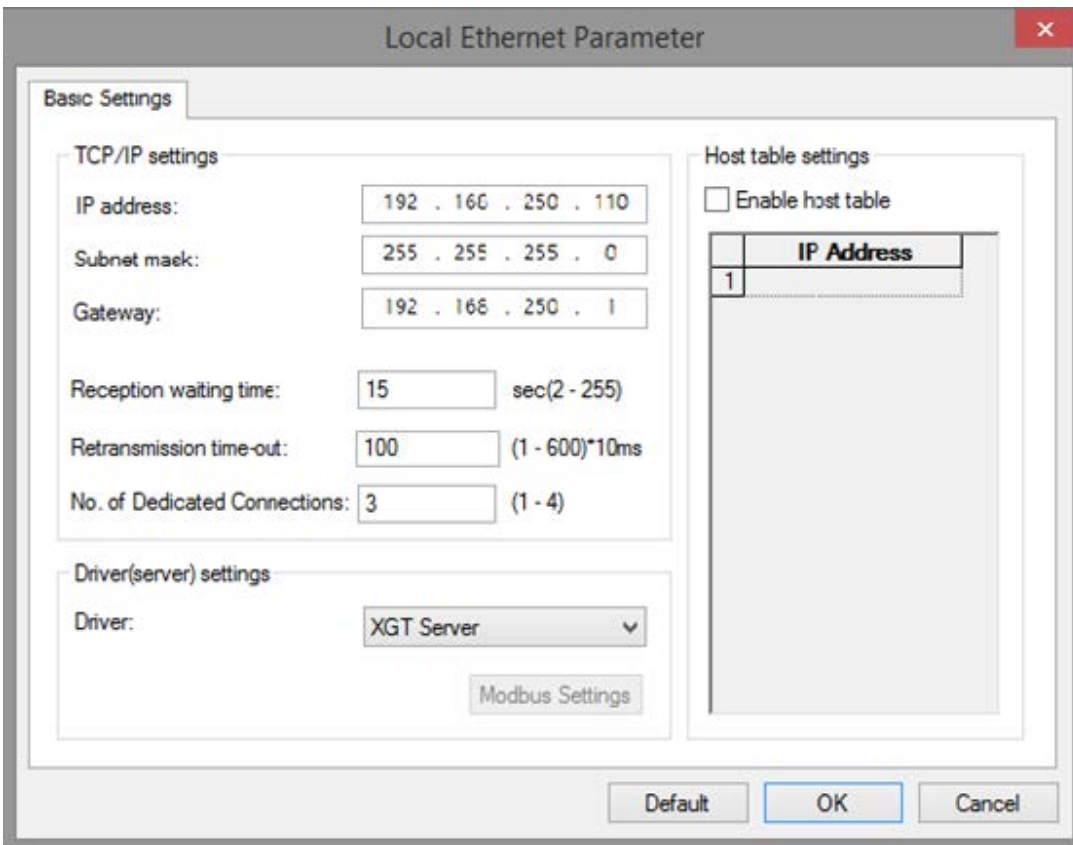

To use the Local Ethernet function, user should set the parameters.



### (1) TCP/IP Setting

Classification	Description
IP address	Specify the IP Address of the applicable CPU module. * Note : There can be a communications disruption if you set more than 2 servers as a same IP
Subnet mask	Value necessary to check if destination station is on the same network of the applicable station.
Gateway	IP address of Gateway or Router to transmit/receive data through the public network or a network different from the network where the applicable FEnet module is included.
Reception waiting time	If there is no request during the specified time from the host PC or MMI connected for dedicated communication, it will end the dedicated service connection regardless of normal ending procedures supposing that the higher level system is with error. This time is used in dedicated service to reset the channel when any error occurs on the destination station or the cable is disconnected. Reception waiting time can be set as a unit of 1 sec (available range is 2s to 255s)
Retransmission time-out (10 ms)	It is the time it takes CPU to send a data to the destination station if the destination station does not answer the data sent by applicable station during setting time. (Applicable station considers it as a data missing.) (available range is 10 ms ~ 6000 ms)  * <b>Note</b> : Retransmission time-out should be set depending on the network situation. If the setting time is too long, it takes a long time to resend a data in case of data missing. This will deteriorate the network performance. But if the setting time is too short, there is a chance to make a frequent disconnection or increase the load to the network.
Number of dedicated connections	Number of TCP dedicated services accessible at a time. (Max.4)

### (2) Driver(Server) setting

Classification	Description
XGT server	Set when operated as dedicated communication server (slave)
Modbus TCP/IP server	Set when operated as Modbus server driver (slave)

### (3) Host table setting

Classification	Description
Enable host table	Access allowed to applicable module of IP address registered in host table (unregistered client(IP address) is prohibited from connection when enabled)

## Chapter 6 Function of CPU Module

### 6.13.2 Local Ethernet connection with XG5000

After finishing Local Ethernet Parameter settings, download the settings to the CPU, then user can connect to XG5000.

Select Online Settings and set the options as shown below figure.

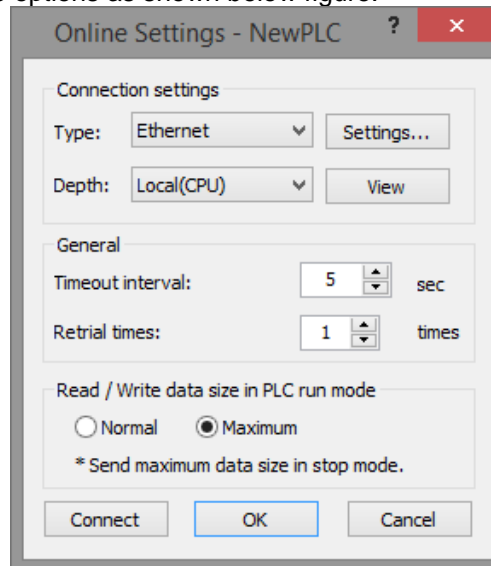

Click the setting button to specify Ethernet IP. Click OK after specify the Ethernet IP set before. User can find the IP information available now.

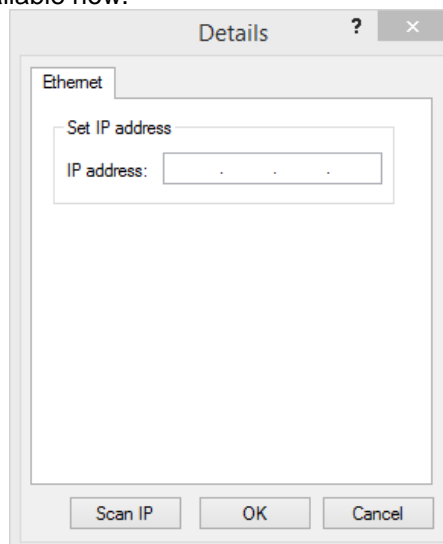

### 6.13.3 Local Ethernet connection with XGT Server.

Set the Local Ethernet Parameters as shown below figure. User can use it as a XGT Server (LSIS dedicated Protocol Communication).

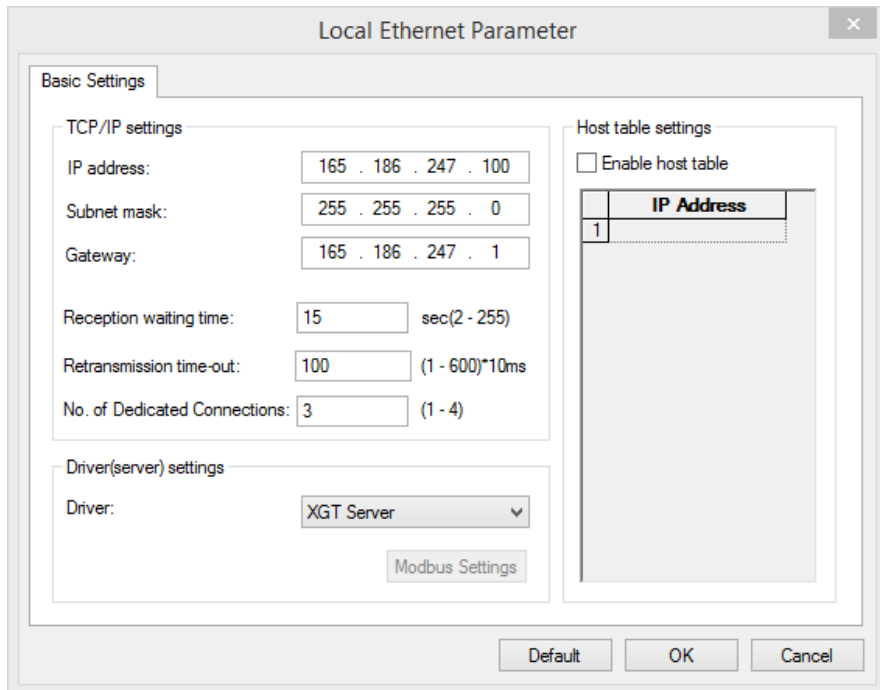

### 6.13.4 Local Ethernet connection with TCP/IP Server.

Set the Local Ethernet Parameters as shown below figure. User can use it as a Modbus server

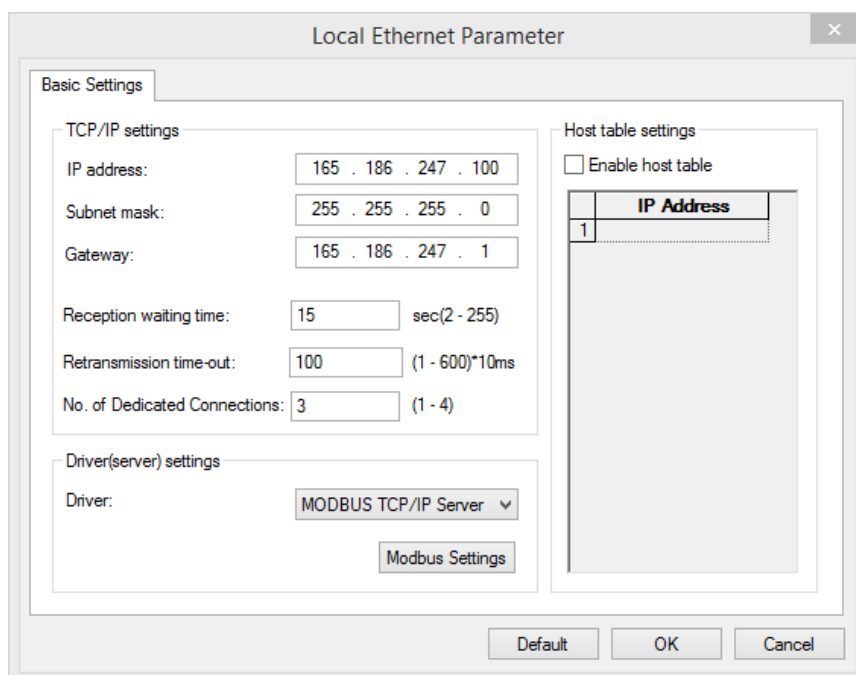

## Chapter 6 Function of CPU Module

---

Below figure is about Modbus settings. .

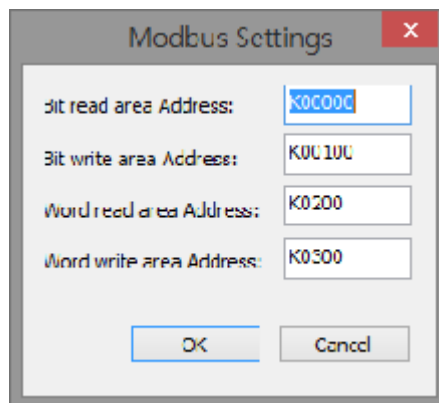

### Note

- 1) Modbus TCP/IP server connection function allows RST packet transmission depending on the network condition.(TCP/IP protocol)  
So the user devices connecting to CPU module should have RST packet process.
- 2) Connection to user devices can be disconnected for retransmission time-out.  
Retransmission time-out = retransmission time-out value(set in the Local Ethernet Parameter window) x 30ms
- 3) Too much Network loads can affect a scan time. So user should consider appropriate network loads for CPU scan time.

## Chapter 9. I/O Module

### 9.1 Cautions for Selecting Module

It describes the cautions when selecting digital I/O modules used for the XGI series.

- 1) There are two digital input types; current sink input and current source input  
Since the wiring method of external input power varies in a DC input module, it should be selected considering the specifications of input connectors.
- 2) The max. simultaneous input point varies depending on a module type. That is, it may be different, depending on input voltage and ambient temperature. Please review the specifications of input module to apply before use.
- 3) In case of an application for highly frequent switching or inductive load switching, the relay output module may have a shorter life, so it needs a transistor module or triac output module, instead of it.
- 4) If an output module operates an inductive load(L), the max. On/Off frequency should be limited to On per 1 second and Off per 1 second, each.
- 5) In case a counter timer using DC/DC converter is used as a load in an output module, setting the average current may cause a trouble because it may have inrush current in case of On or a certain cycle during operation. Therefore, if using the foresaid load, it is necessary to connect resistance or inductor parallel to load or alternatively use a module of which max. load current is large.

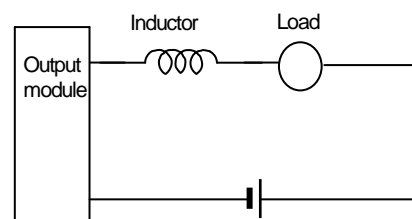
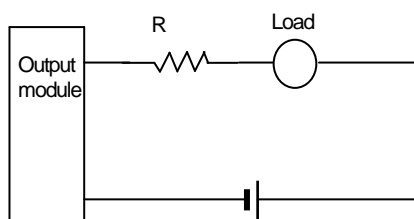

- 6) A fuse in an output module can not be replaced. That's why it is intended to prevent external wiring from being damaged when the output of a module is short-circuited. Therefore, the output module may not be protected. If an output module is destructed in any other fault mode save for short-circuit, a fuse may not work.

## Chapter 9. I/O Module

- 7) The following figure shows the relay life of relay output module.  
It also shows the max. life of relay used for relay output.

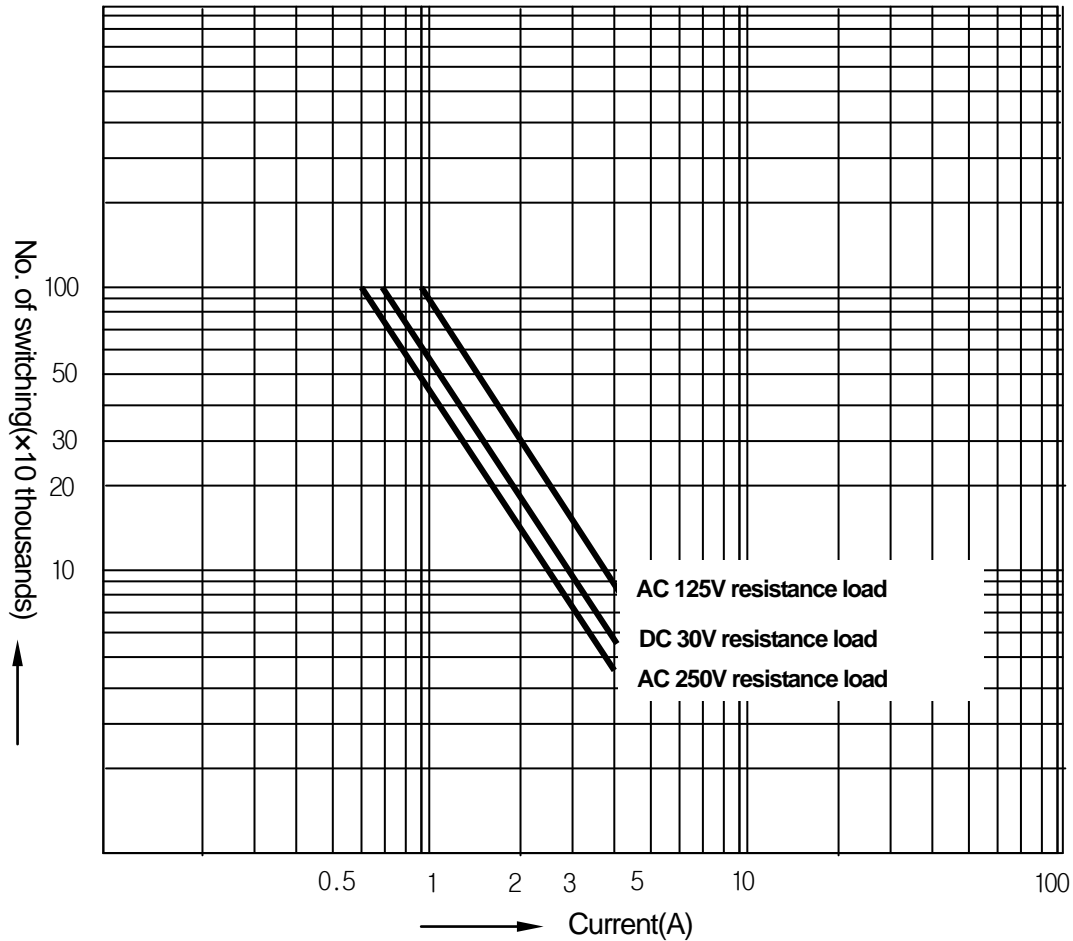

- 8) A clamped terminal with sleeve can not be used for the XGI terminal strip. The clamped terminals suitable for terminal strip are as follows(JOR 1.25-3:Daedong Electricity).

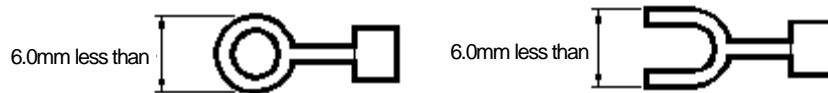

- 9) The cable size connected to a terminal strip should be 0.3~0.75 mm<sup>2</sup> stranded cable and 2.8 mm thick. The cable may have different current allowance depending on the insulation thickness.
- 10) The coupling torque available for fixation screw and terminal strip screw should follow the table below.

Coupling position	Coupling torque range
IO module terminal strip screw(M3 screw)	42 ~ 58 N·cm
IO module terminal strip fixation screw(M3 screw)	66 ~ 89 N·cm

- 11) Transistor output module(XGQ-TR4A, XGQ-TR8A) supports terminal protector function.  
Thermal Protector is the function to prevent overload and overheat.

9.2 Digital Input Module Specifications

9.2.1 8 point DC24V input module (source/sink type)

Spec.		Module type	DC Input module XGI-D21A
Input point			8 points
Insulation method			Photo coupler insulation
Rated input voltage			DC24V
Rated input current			Approx. 4 mA
Voltage range			DC20.4~28.8V (5% and lower ripple rate )
Input derating			None
On voltage / On current			DC19V and higher / 3 mA and higher
Off voltage / Off current			DC11V and lower / 1.7 mA and lower
Input resistance			Approx. 5.6 kΩ
Response time	Off → On		1ms/3ms/5ms/10ms/20ms/70ms/100ms (Set by CPU Parameter) Initial value:3ms
	On → Off		1ms/3ms/5ms/10ms/20ms/70ms/100ms (Set by CPU Parameter) Initial value:3ms
Withstand voltage			AC560V rms/3 Cycle (altitude 2000m)
Insulation resistance			10 MΩ and higher by Insulation ohmmeter
Common method			16 point/ COM
Suitable cable size			Stranded cable between 0.3~0.75 mm <sup>2</sup> (2.8mm and smaller outer dia.)
Suitable clamped terminal			R1.25-3 (Sleeve built-in clamped terminal is not available)
Current consumption(mA)			20mA
Operation display			LED On with Input On
External connection method			9 point Terminal strip connector (M3 X 6 screws)
Weight			0.1 kg

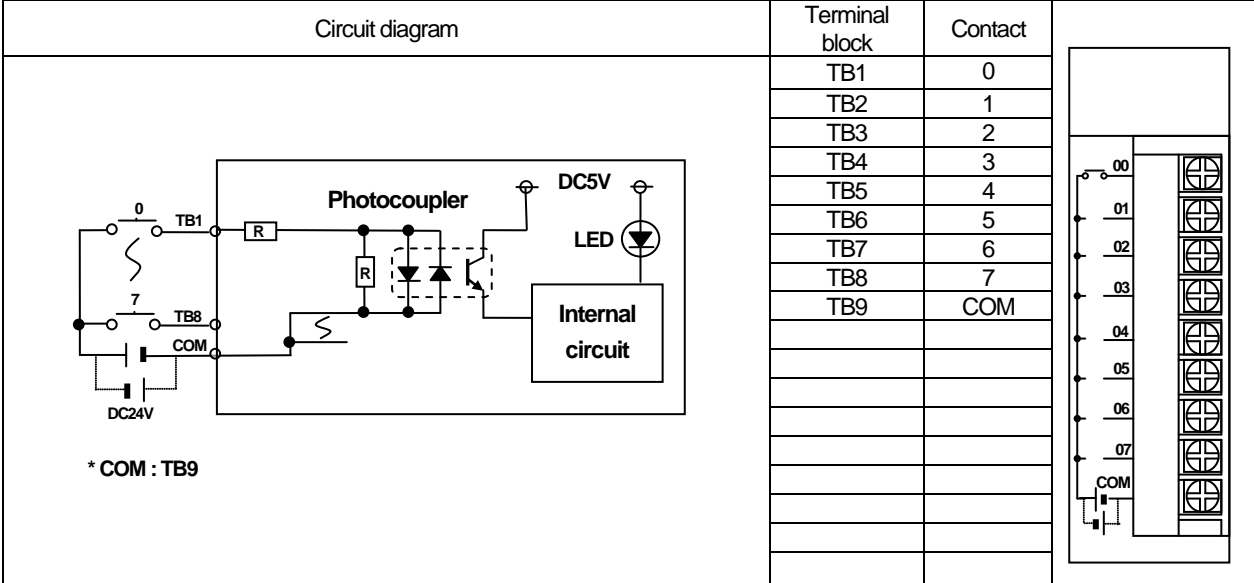

9.2.2 16 point DC24V input module (source/sink type)

Spec.		Module type	DC Input module XGI-D22A	
Input point		16 points		
Insulation method		Photo coupler insulation		
Rated input voltage		DC24V		
Rated input current		Approx. 4 mA		
Voltage range		DC20.4~28.8V (5% and lower ripple rate )		
Input derating		None		
On voltage / On current		DC 19V and higher / 3mA and higher		
Off voltage / Off current		DC 11V and lower / 1.7mA and lower		
Input resistance		Approx. 5.6 kΩ		
Response time	Off → On	1ms/3ms/5ms/10ms/20ms/70ms/100ms (Set by CPU Parameter) Initial value:3ms		
	On → Off	1ms/3ms/5ms/10ms/20ms/70ms/100ms (Set by CPU Parameter) Initial value:3ms		
Insulation withstand voltage		AC560V rms/3 Cycle (altitude 2000m)		
Insulation resistance		10 MΩ and higher by Insulation ohmmeter		
Common method		16 point/ COM		
Suitable cable size		Stranded cable between 0.3~0.75 mm <sup>2</sup> (2.8mm and smaller outer dia.)		
Suitable clamped terminal		R1.25-3 (Sleeve built-in clamped terminal is not available)		
Current consumption(mA)		30mA		
Operation display		LED On with Input On		
External connection method		18 point Terminal strip connector (M3 X 6 screws)		
Weight		0.12 kg		
Circuit diagram			Terminal block	
<p>* COM : TB17</p>			Contact	
			TB1	0
			TB2	1
			TB3	2
			TB4	3
			TB5	4
			TB6	5
			TB7	6
			TB8	7
			TB9	8
			TB10	9
			TB11	10
			TB12	11
			TB13	12
			TB14	13
			TB15	14
			TB16	15
			TB17	COM
TB18	NC			



9.2.3 16 point DC24V input module (source type)

Spec.		Module type	DC Input module	
			XGI-D22B	
Input point		16 points		
Insulation method		Photo coupler insulation		
Rated input voltage		DC24V		
Rated input current		Approx. 4 mA		
Voltage range		DC20.4~28.8V (5% and lower ripple rate )		
Input derating		None		
On voltage / On current		DC 19V and higher / 3mA and higher		
Off voltage / Off current		DC 11V and lower / 1.7mA and lower		
Input resistance		Approx. 5.6 kΩ		
Response time	Off → On	1ms/3ms/5ms/10ms/20ms/70ms/100ms (Set by CPU Parameter) Initial value:3ms		
	On → Off	1ms/3ms/5ms/10ms/20ms/70ms/100ms (Set by CPU Parameter) Initial value:3ms		
Insulation withstand voltage		AC560V rms/3 Cycle (altitude 2000m)		
Insulation resistance		10 MΩ and higher by Insulation ohmmeter		
Common method		16 point/ COM		
Suitable cable size		Stranded cable between 0.3~0.75 mm <sup>2</sup> (2.8mm and smaller outer dia.)		
Suitable clamped terminal		R1.25-3 (Sleeve built-in clamped terminal is not available)		
Current consumption(mA)		30mA		
Operation display		LED On with Input On		
External connection method		18point Terminal strip connector (M3 X 6 screws)		
Weight		0.12 kg		
Circuit diagram			Terminal block	
<p>* COM : TB17</p>			Contact	
			TB1	0
			TB2	1
			TB3	2
			TB4	3
			TB5	4
			TB6	5
			TB7	6
			TB8	7
			TB9	8
			TB10	9
			TB11	10
			TB12	11
			TB13	12
			TB14	13
			TB15	14
			TB16	15
			TB17	COM
TB18	NC			

9.2.4 32 point DC24V input module (source/sink type)

Spec.		Module type	DC Input module
			XGI-D24A
Input point		32 points	
Insulation method		Photo coupler insulation	
Rated input voltage		DC24V	
Rated input current		Approx. 4 mA	
Voltage range		DC20.4~28.8V (5% and lower ripple rate )	
Input derating		Refer to the below derating level	
On voltage / On current		DC 19V and higher / 3mA and higher	
Off voltage / Off current		DC 11V and lower / 1.7mA and lower	
Input resistance		Approx. 5.6 kΩ	
Response time	Off → On	1ms/3ms/5ms/10ms/20ms/70ms/100ms (Set by CPU Parameter) Initial value:3ms	
	On → Off	1ms/3ms/5ms/10ms/20ms/70ms/100ms (Set by CPU Parameter) Initial value:3ms	
Insulation withstand voltage		AC560V rms/3 Cycle (altitude 2000m)	
Insulation resistance		10 MΩ and higher by Insulation ohmmeter	
Common method		32points / COM	
Suitable cable size		0.3 mm <sup>2</sup>	
Current consumption(mA)		50mA	
Operation display		LED On with Input On	
External connection method		40point connector	
Weight		0.1 kg	

Circuit diagram

\* COM : B02, B01, A02, A01

No	Contact	No	Contact
B20	0	A20	16
B19	1	A19	17
B18	2	A18	18
B17	3	A17	19
B16	4	A16	20
B15	5	A15	21
B14	6	A14	22
B13	7	A13	23
B12	8	A12	24
B11	9	A11	25
B10	10	A10	26
B09	11	A09	27
B08	12	A08	28
B07	13	A07	29
B06	14	A06	30
B05	15	A05	31
B04	NC	A04	NC
B03	NC	A03	NC
B02	COM	A02	COM
B01	COM	A01	COM

Derating level

9.2.5 32 point DC24V input module (source type)

Spec.		Module type
		DC Input module XGI-D24B
Input point		32 points
Insulation method		Photo coupler insulation
Rated input voltage		DC24V
Rated input current		Approx. 4 mA
Voltage range		DC20.4~28.8V (5% and lower ripple rate )
Input derating		Refer to the below derating level
On voltage / On current		DC19V and higher / 3 mA and higher
Off voltage / Off current		DC 11V and lower / 1.7mA and lower
Input resistance		Approx. 5.6 kΩ
Response time	Off → On	1ms/3ms/5ms/10ms/20ms/70ms/100ms (Set by CPU Parameter) Initial value:3ms
	On → Off	1ms/3ms/5ms/10ms/20ms/70ms/100ms (Set by CPU Parameter) Initial value:3ms
Insulation withstand voltage		AC560V rms/3 Cycle (altitude 2000m)
Insulation resistance		10 MΩ and higher by Insulation ohmmeter
Common method		32 points / COM
Suitable cable size		0.3 mm <sup>2</sup>
Current consumption(mA)		50mA
Operation display		LED On with Input On
External connection method		40point connector
Weight		0.1 kg

Circuit diagram

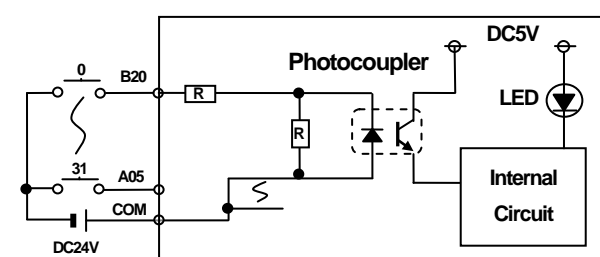

\* COM : B02, B01, A02, A01

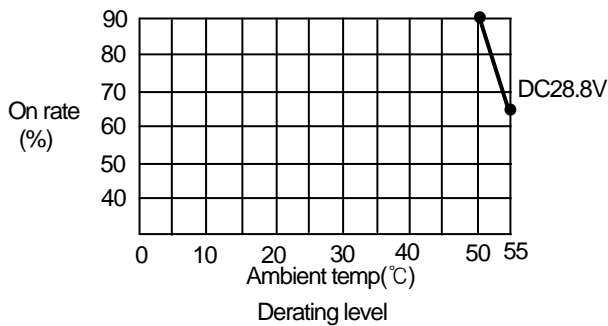

No	Contact	No	Contact
B20	0	A20	16
B19	1	A19	17
B18	2	A18	18
B17	3	A17	19
B16	4	A16	20
B15	5	A15	21
B14	6	A14	22
B13	7	A13	23
B12	8	A12	24
B11	9	A11	25
B10	10	A10	26
B09	11	A09	27
B08	12	A08	28
B07	13	A07	29
B06	14	A06	30
B05	15	A05	31
B04	NC	A04	NC
B03	NC	A03	NC
B02	COM	A02	COM
B01	COM	A01	COM

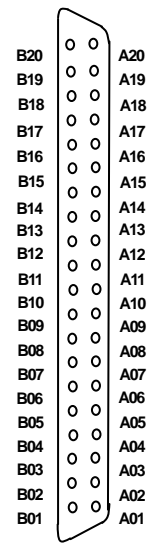

9.2.6 64 point DC24V input module (source/sink type)

Module type		DC Input module								
Spec.		XGI-D28A								
Input point		64 points								
Insulation method		Photo coupler insulation								
Rated input voltage		DC24V								
Rated input current		Approx. 4 mA								
Voltage range		DC20.4~28.8V (5% and lower ripple rate )								
Input derating		Refer to the below derating level								
On voltage / On current		DC 19V and higher / 3mA and higher								
Off voltage / Off current		DC 11V and lower / 1.7mA and lower								
Input resistance		Approx. 5.6 kΩ								
Response time	Off → On	1ms/3ms/5ms/10ms/20ms/70ms/100ms (Set by CPU Parameter) Initial value:3ms								
	On → Off	1ms/3ms/5ms/10ms/20ms/70ms/100ms (Set by CPU Parameter) Initial value:3ms								
Insulation withstand voltage		AC560V rms/3 Cycle (altitude 2000m)								
Insulation resistance		10 MΩ and higher by Insulation ohmmeter								
Common method		32point / COM								
Suitable cable size		0.3 mm <sup>2</sup>								
Current consumption(mA)		60mA								
Operation display		LED On with Input On (32point LED on by switching)								
External connection method		40point connector x 2								
Weight		0.15 kg								
Circuit diagram		No	Contact	No	Contact	No	Contact	No	Contact	
<p>* COM : 1B02, 1B01 2B02, 2B01</p> <p>A: Displaying 0-31 B: Displaying 32-63</p>		1B20	0	1A20	16	2B20	32	2A20	48	
		1B19	1	1A19	17	2B19	33	2A19	49	
		1B18	2	1A18	18	2B18	34	2A18	50	
		1B17	3	1A17	19	2B17	35	2A17	51	
		1B16	4	1A16	20	2B16	36	2A16	52	
		1B15	5	1A15	21	2B15	37	2A15	53	
		1B14	6	1A14	22	2B14	38	2A14	54	
		1B13	7	1A13	23	2B13	39	2A13	55	
		1B12	8	1A12	24	2B12	40	2A12	56	
		1B11	9	1A11	25	2B11	41	2A11	57	
		1B10	10	1A10	26	2B10	42	2A10	58	
		1B09	11	1A09	27	2B09	43	2A09	59	
		1B08	12	1A08	28	2B08	44	2A08	60	
		1B07	13	1A07	29	2B07	45	2A07	61	
		1B06	14	1A06	30	2B06	46	2A06	62	
		1B05	15	1A05	31	2B05	47	2A05	63	
		1B04	NC	1A04	NC	2B04	NC	2A04	NC	
		1B03	NC	1A03	NC	2B03	NC	2A03	NC	
		1B02	COM	1A02	NC	2B02	COM	2A02	NC	
		1B01	COM	1A01	NC	2B01	COM	2A01	NC	
<p>On rate (%)</p> <p>Ambient temp(°C)</p> <p>Derating level</p>										

9.2.7 64 point DC24V input module (source type)

Spec.	Module type	DC Input module									
		XGI-D28B									
Input point	64 points										
Insulation method	Photo coupler insulation										
Rated input voltage	DC24V										
Rated input current	Approx. 4 mA										
Voltage range	DC20.4~28.8V (5% and lower ripple rate )										
Input derating	Refer to the below derating level										
On voltage / On current	DC 19V and higher / 3mA and higher										
Off voltage / Off current	DC 11V and lower / 1.7mA and lower										
Input resistance	Approx. 5.6 kΩ										
Response time	Off → On	1ms/3ms/5ms/10ms/20ms/70ms/100ms(Set by CPU Parameter) Initial value:3ms									
	On → Off	1ms/3ms/5ms/10ms/20ms/70ms/100ms (Set by CPU Parameter) Initial value:3ms									
Insulation withstand voltage	AC560V rms/3 Cycle (altitude 2000m)										
Insulation resistance	10 MΩ and higher by Insulation ohmmeter										
Common method	32 points / COM										
Suitable cable size	0.3 mm <sup>2</sup>										
Current consumption(mA)	60mA										
Operation display	LED On with Input On (32point LED on by switching)										
External connection method	40point connector × 2										
Weight	0.15 kg										
Circuit diagram		No	Contact	No	Contact	No	Contact	No	Contact		
<p>* COM : 1B02, 1B01 2B02, 2B01</p> <p>A: Displaying 0~31 B: Displaying 32~63</p>		1B20	0	1A20	16	2B20	32	2A20	48		
		1B19	1	1A19	17	2B19	33	2A19	49		
		1B18	2	1A18	18	2B18	34	2A18	50		
		1B17	3	1A17	19	2B17	35	2A17	51		
		1B16	4	1A16	20	2B16	36	2A16	52		
		1B15	5	1A15	21	2B15	37	2A15	53		
		1B14	6	1A14	22	2B14	38	2A14	54		
		1B13	7	1A13	23	2B13	39	2A13	55		
		1B12	8	1A12	24	2B12	40	2A12	56		
		1B11	9	1A11	25	2B11	41	2A11	57		
		1B10	10	1A10	26	2B10	42	2A10	58		
		1B09	11	1A09	27	2B09	43	2A09	59		
		1B08	12	1A08	28	2B08	44	2A08	60		
		1B07	13	1A07	29	2B07	45	2A07	61		
		1B06	14	1A06	30	2B06	46	2A06	62		
		1B05	15	1A05	31	2B05	47	2A05	63		
1B04	NC	1A04	NC	2B04	NC	2A04	NC				
1B03	NC	1A03	NC	2B03	NC	2A03	NC				
1B02	COM	1A02	NC	2B02	COM	2A02	NC				
1B01	COM	1A01	NC	2B01	COM	2A01	NC				
<p>On rate (%)</p> <p>Ambient temp(°C)</p> <p>Derating level</p>											

9.2.8 16 point AC110V input module

Module type		AC Input module
Spec.		XGI-A12A
Input point	16 points	
Insulation method	Photo coupler insulation	
Rated input voltage	AC100-120V(+10/-15%) 50/60 Hz(±3 Hz) (5% and lower distortion)	
Rated input current	Approx. 8 mA (AC100,60 Hz) , approx. 7 mA (AC100,50 Hz)	
Inrush current	Max. 200 mA 1 ms and lower(AC132V )	
Input derating	Refer to the below derating level	
On voltage / On current	AC80V and higher / 5 mA and higher(50 Hz,60 Hz)	
Off voltage / Off current	AC30V and lower / 1 mA and lower (50 Hz,60 Hz)	
Input resistance	Approx. 12 kΩ(60 Hz), approx. 15 kΩ(50 Hz)	
Response time	Off → On	15 ms and lower(AC100V 50 Hz,60 Hz)
	On → Off	25 ms and lower(AC100V 50 Hz,60 Hz)
Insulation withstand voltage	AC1780V rms/3 Cycle (altitude 2000m)	
Insulation resistance	10 MΩ and higher by Insulation ohmmeter	
Common method	16 point/ COM	
Suitable cable size	Stranded cable between 0.3~0.75 mm <sup>2</sup> (2.8mm and smaller outer dia.)	
Suitable clamped terminal	R1.25-3 (Sleeve built-in clamped terminal is not available)	
Current consumption(mA)	30mA	
Operation display	LED On with Input On	
External connection method	18point Terminal strip connector (M3 X 6 screws)	
Weight	0.13 kg	

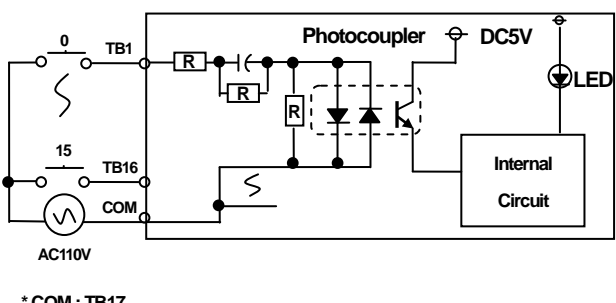
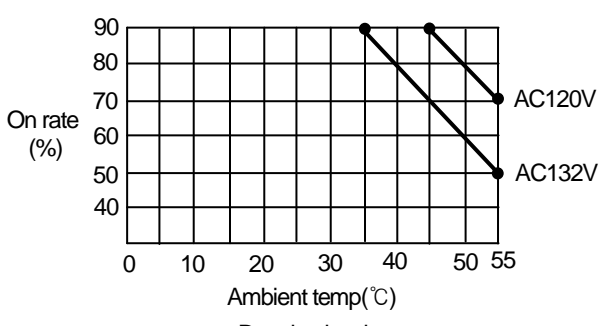
Circuit diagram	Terminal block	Contact
 <p>* COM : TB17</p>  <p>Derating level</p>	TB1	0
	TB2	1
	TB3	2
	TB4	3
	TB5	4
	TB6	5
	TB7	6
	TB8	7
	TB9	8
	TB10	9
	TB11	10
	TB12	11
	TB13	12
	TB14	13
	TB15	14
	TB16	15
	TB17	COM
	TB18	NC

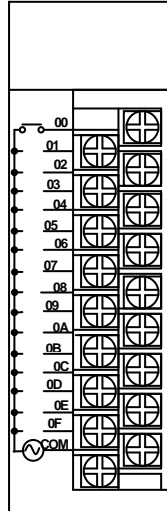

9.2.9 8 point AC220V input module

Spec.	Module type	AC input module
		XGI-A21A
Input point	8 points	
Insulation method	Photo coupler insulation	
Rated input voltage	AC100-240V(+10/-15%) 50/60 Hz(±3 Hz) (5% and lower distortion)	
Rated input current	Approx. 17 mA (AC200,60 Hz) , approx. 14 mA (AC200,50 Hz)	
Inrush current	Max. 500 mA 1 ms and lower(AC264V)	
Input derating	Refer to the below derating level	
On voltage / On current	AC80V and higher / 5 mA and higher(50 Hz,60 Hz)	
Off voltage / Off current	AC30V and lower / 1 mA and lower (50 Hz,60 Hz)	
Input resistance	Approx. 12 kΩ(60 Hz), approx. 15 kΩ(50 Hz)	
Response time	Off → On	15 ms and lower(AC200V 50 Hz,60 Hz)
	On → Off	25 ms and lower(AC200V 50 Hz,60 Hz)
Insulation withstand voltage	AC2830V rms/3 Cycle (altitude 2000m)	
Insulation resistance	10 MΩ and higher by Insulation ohmmeter	
Common method	8 points / COM	
Suitable cable size	Stranded cable between 0.3~0.75 mm <sup>2</sup> (2.8mm and smaller outer dia.)	
Suitable clamped terminal	R1.25-3 (Sleeve built-in clamped terminal is not available)	
Current consumption(mA)	20mA	
Operation display	LED On with Input On	
External connection method	9point Terminal strip connector (M3 X 6 screws)	
Weight	0.13 kg	

Circuit diagram	Terminal block	Contact
<p>AC110/220V</p> <p>* COM : TB9</p>	TB1	0
	TB2	1
	TB3	2
	TB4	3
	TB5	4
	TB6	5
	TB7	6
	TB8	7
	TB9	COM

  

Ambient temp(°C)	On rate (%)	Derating level
37°C	85%	AC240V
49°C	70%	AC240V
55°C	40%	AC264V

9.2.10 8 point AC220V isolated input module

Spec.	Module type	AC input module
		XGI-A21C
Input point	8 points	
Insulation method	Photo coupler insulation	
Rated input voltage	AC100-240V(+10/-15%) 50/60 Hz(±3 Hz) (5% and lower distortion)	
Rated input current	Approx. 17 mA (AC200,60 Hz) , approx. 14 mA (AC200,50 Hz)	
Inrush current	Max. 500 mA 1 ms and lower(AC264V)	
Input derating	Refer to the below derating level	
On voltage / On current	AC80V and higher / 5 mA and higher (50 Hz,60 Hz)	
Off voltage / Off current	AC30V and lower / 1 mA and lower (50 Hz,60 Hz)	
Input resistance	Approx. 12 kΩ(60 Hz), approx. 15 kΩ(50 Hz)	
Response time	Off → On	15 ms and lower(AC200V 50 Hz, 60 Hz)
	On → Off	25 ms and lower(AC200V 50 Hz, 60 Hz)
Insulation withstand voltage	AC2830V rms/3 Cycle (altitude 2000m)	
Insulation resistance	10 MΩ and higher by Insulation ohmmeter	
Common method	1 point / COM	
Suitable cable size	Stranded cable between 0.3~0.75 mm <sup>2</sup> (2.8mm and smaller outer dia.)	
Suitable clamped terminal	R1.25-3 (Sleeve built-in clamped terminal is not available)	
Current consumption(mA)	20mA	
Operation display	LED On with Input On	
External connection method	18 point Terminal strip connector (M3 X 6 screws)	
Weight	0.13 kg	

Circuit diagram	Terminal block	Contact
	TB1	0
	TB2	COM0
	TB3	1
	TB4	COM1
	TB5	2
	TB6	COM2
	TB7	3
	TB8	COM3
	TB9	4
	TB10	COM4
	TB11	5
	TB12	COM5
	TB13	6
	TB14	COM6
	TB15	7
	TB16	COM7
	TB17	NC
	TB18	NC

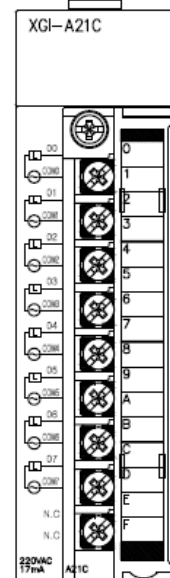



**9.3 Digital Output Module Spec.**

**9.3.1 8 point relay output module**

Module type		Relay output module
Spec.		XGQ-RY1A
Output point	8 points	
Insulation method	Relay insulation	
Rated load voltage/current	DC24V 2A(resistance load) / AC220V 2A(COSΨ = 1)	
Min. load voltage / current	DC5V / 1mA	
Max. load voltage / current	AC250V, DC125V	
Leakage current at Off	0.1mA (AC220V, 60Hz)	
Max. switching frequency	3,600 times/hr	
Surge killer	None	
Life	Mechanical	20 million and more times
	Electrical	Rated load voltage/current 100 thousand and more times
		AC200V / 1.5A, AC240V / 1A (COSΨ = 0.7) 100 thousand and more times
		AC200V / 1A, AC240V / 0.5A (COSΨ = 0.35) 100 thousand and more times
Response time	Off → On	10 ms and lower
	On → Off	12 ms and lower
Common method	1 point/ 1COM (Independent contact)	
Current consumption	260mA (when every point is On)	
Operation display	LED On with output On	
External connection method	18 point Terminal strip connector (M3 X 6 screws)	
Weight	0.13kg	

Circuit diagram	Terminal block	Contact
	TB1	0
	TB2	COM
	TB3	1
	TB4	COM
	TB5	2
	TB6	COM
	TB7	3
	TB8	COM
	TB9	4
	TB10	COM
	TB11	5
	TB12	COM
	TB13	6
	TB14	COM
	TB15	7
	TB16	COM
	TB17	NC
	TB18	NC

9.3.2 16 point relay output module

Spec.		Module type	Relay output module	
			XGQ-RY2A	
Output point		16 points		
Insulation method		Relay insulation		
Rated load voltage/current		DC24V 2A(resistance load) / AC220V 2A(COSΨ = 1)		
Min. load voltage / current		DC5V / 1mA		
Max. load voltage / current		AC250V, DC125V		
Leakage current at Off		0.1mA (AC220V, 60Hz)		
Max. switching frequency		3,600 times/hr		
Surge killer		None		
Life	Mechanical	20 million and more times		
	Electrical	Rated load voltage/current 100 thousand and more times		
		AC200V / 1.5A, AC240V / 1A (COSΨ = 0.7) 100 thousand and more times		
		AC200V / 1A, AC240V / 0.5A (COSΨ = 0.35) 100 thousand and more times		
Response time	Off → On	10 ms and lower		
	On → Off	12 ms and lower		
Common method		16 point/ 1COM		
Current consumption		500mA (when every point is On)		
Operation display		LED On with output On		
External connection method		18point Terminal strip connector (M3 X 6 screws)		
Weight		0.17kg		
Circuit diagram			Terminal block	
			Contact	
			TB1	0
			TB2	1
			TB3	2
			TB4	3
			TB5	4
			TB6	5
			TB7	6
			TB8	7
			TB9	8
TB10	9			
TB11	10			
TB12	11			
TB13	12			
TB14	13			
TB15	14			
TB16	15			
TB17	COM			
TB18	NC			

9.3.3 16 point relay output module (Surge Killer built-in type)

Module		Relay output module	
type	Spec.	XGQ-RY2B	
Output point		16 points	
Insulation method		Relay insulation	
Rated load voltage/current		DC24V 2A(resistance load) / AC220V 2A(COSΨ = 1)	
Min. load voltage / current		DC5V / 1mA	
Max. load voltage / current		AC250V, DC125V	
Leakage current at Off		0.1mA (AC220V, 60Hz)	
Max. switching frequency		3,600 times/hr	
Surge killer		Varistor (387 ~ 473V), C.R absorber	
Life	Mechanical	20 million and more times	
	Electrical	Rated load voltage/current 100 thousand and more times	
		AC200V / 1.5A, AC240V / 1A (COSΨ = 0.7) 100 thousand and more times	
		AC200V / 1A, AC240V / 0.5A (COSΨ = 0.35) 100 thousand and more times	
DC24V / 1A, DC100V / 0.1A (L / R = 7ms) 100 thousand and more times			
Response time	Off → On	10 ms and lower	
	On → Off	12 ms and lower	
Common method		16 point/ 1COM	
Current consumption		500mA (when every point is On)	
Operation display		LED On with output On	
External connection method		18 point Terminal strip connector (M3 X 6 screws)	
Weight		0.19kg	
Circuit diagram		Terminal block	Contact
		TB1	0
		TB2	1
		TB3	2
		TB4	3
		TB5	4
		TB6	5
		TB7	6
		TB8	7
		TB9	8
		TB10	9
		TB11	10
		TB12	11
		TB13	12
		TB14	13
		TB15	14
		TB16	15
		TB17	COM
		TB18	NC

9.3.4 16 point Triac output module

Module type		Triac output module
Spec.		XGQ-SS2A
Output point		16 points
Insulation method		Photo coupler insulation
Rated load voltage		AC 100-240V (50 / 60 Hz)
Max. load voltage		AC 264V
Max. load current		0.6A / 1 point, 4A / 1COM
Min. load current		20 mA
Leakage current at Off		2.5 mA (AC 220V 60 Hz)
Max. inrush current		20A / Cycle and lower
Max. voltage drop at On		AC 1.5V and lower (2A)
Surge killer		Varistor (387 ~ 473V), C.R absorber
Response time	Off → On	1 ms and shorter
	On → Off	0.5 Cycle + 1 ms and shorter
Common method		16 point/ 1 COM
Current consumption		300 mA (when every point is On)
Operation display		LED On with output On
External connection method		18point Terminal strip connector (M3 X 6 screw)
Weight		0.2 kg

Circuit diagram		Terminal block	Contact
<p style="text-align: center;">*COM : TB17</p>		TB1	0
		TB2	1
		TB3	2
		TB4	3
		TB5	4
		TB6	5
		TB7	6
		TB8	7
		TB9	8
		TB10	9
		TB11	10
		TB12	11
		TB13	12
		TB14	13
		TB15	14
		TB16	15
		TB17	COM
		TB18	NC

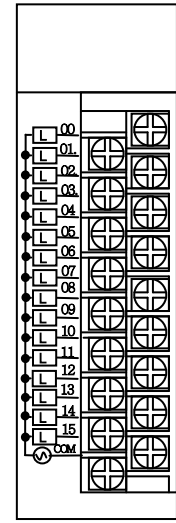

9.3.5 16 point transistor output module (sink type)

Module type		Transistor output module	
Spec.		XGQ-TR2A	
Output point		16 points	
Insulation method		Photo coupler insulation	
Rated load voltage		DC 12 / 24V	
Operating load voltage range		DC 10.2 ~ 26.4V	
Max. load current		0.5A / 1point, 4A / 1COM	
Leakage current at Off		0.1mA and lower	
Max. inrush current		4A / 10 ms and lower	
Max. voltage drop at On		DC 0.3V AND LOWER	
Surge killer		Zener diode	
Fuse		4Ax2(not replaceable)(Fuse cap.:50A)	
Fuse disconnection display		Yes(If a fuse is burnt out, it transfers a signal to CPU and LED is on) If external power supply is off, fuse status is not detected.	
Response time	Off → On	1 ms and shorter	
	On → Off	1 ms and shorter (Rated load, resistance load)	
Common method		16 point/ 1COM	
Current consumption		70mA (when every point is On)	
External power supply	Voltage	DC12/24V ± 10% (4 Vp-p and lower ripple voltage)	
	Current	10mA and lower (if connected to DC24V)	
Operation display		LED On with output On	
External connection method		18point Terminal strip connector	
Weight		0.11kg	
Circuit diagram			
		Terminal block	Contact
		TB1	0
		TB2	1
		TB3	2
		TB4	3
		TB5	4
		TB6	5
		TB7	6
		TB8	7
		TB9	8
		TB10	9
		TB11	10
		TB12	11
		TB13	12
		TB14	13
		TB15	14
		TB16	15
		TB17	DC24V
		TB18	COM

9.3.6 32 point transistor output module(sink type)

Module type		Transistor output module																																																																																					
Spec.		XGQ-TR4A																																																																																					
Output point	32 point																																																																																						
Insulation method	Photo coupler insulation																																																																																						
Rated load voltage	DC 12 / 24V																																																																																						
Operating load voltage range	DC 10.2 ~ 26.4V																																																																																						
Max. load current	0.1A / 1point, 2A / 1COM																																																																																						
Leakage current at Off	0.1mA and lower																																																																																						
Max. inrush current	0.7A / 10 ms and lower																																																																																						
Max. voltage drop at On	DC 0.2V and lower																																																																																						
Surge killer	Zener diode																																																																																						
Response time	Off → On	1 ms and shorter																																																																																					
	On → Off	1 ms and shorter (Rated load, resistance load)																																																																																					
Common method	32 points / 1COM																																																																																						
Current consumption	130mA (when every point is On)																																																																																						
External power supply	Voltage	DC12/24V ± 10% (4 Vp-p and lower ripple voltage)																																																																																					
	Current	10mA and lower (if connected to DC24V)																																																																																					
Operation display	LED On with Input On																																																																																						
External connection method	40 Pin Connector																																																																																						
Suitable cable size	0.3 mm <sup>2</sup>																																																																																						
Weight	0.1 kg																																																																																						
Circuit diagram																																																																																							
		<table border="1"> <thead> <tr> <th>No</th> <th>Contact</th> <th>No</th> <th>Contact</th> </tr> </thead> <tbody> <tr><td>B20</td><td>0</td><td>A20</td><td>16</td></tr> <tr><td>B19</td><td>1</td><td>A19</td><td>17</td></tr> <tr><td>B18</td><td>2</td><td>A18</td><td>18</td></tr> <tr><td>B17</td><td>3</td><td>A17</td><td>19</td></tr> <tr><td>B16</td><td>4</td><td>A16</td><td>20</td></tr> <tr><td>B15</td><td>5</td><td>A15</td><td>21</td></tr> <tr><td>B14</td><td>6</td><td>A14</td><td>22</td></tr> <tr><td>B13</td><td>7</td><td>A13</td><td>23</td></tr> <tr><td>B12</td><td>8</td><td>A12</td><td>24</td></tr> <tr><td>B11</td><td>9</td><td>A11</td><td>25</td></tr> <tr><td>B10</td><td>10</td><td>A10</td><td>26</td></tr> <tr><td>B09</td><td>11</td><td>A09</td><td>27</td></tr> <tr><td>B08</td><td>12</td><td>A08</td><td>28</td></tr> <tr><td>B07</td><td>13</td><td>A07</td><td>29</td></tr> <tr><td>B06</td><td>14</td><td>A06</td><td>30</td></tr> <tr><td>B05</td><td>15</td><td>A05</td><td>31</td></tr> <tr><td>B04</td><td>NC</td><td>A04</td><td>NC</td></tr> <tr><td>B03</td><td>NC</td><td>A03</td><td>NC</td></tr> <tr><td>B02</td><td>DC12/</td><td>A02</td><td>COM</td></tr> <tr><td>B01</td><td>24V</td><td>A01</td><td>COM</td></tr> </tbody> </table>		No	Contact	No	Contact	B20	0	A20	16	B19	1	A19	17	B18	2	A18	18	B17	3	A17	19	B16	4	A16	20	B15	5	A15	21	B14	6	A14	22	B13	7	A13	23	B12	8	A12	24	B11	9	A11	25	B10	10	A10	26	B09	11	A09	27	B08	12	A08	28	B07	13	A07	29	B06	14	A06	30	B05	15	A05	31	B04	NC	A04	NC	B03	NC	A03	NC	B02	DC12/	A02	COM	B01	24V	A01	COM
No	Contact	No	Contact																																																																																				
B20	0	A20	16																																																																																				
B19	1	A19	17																																																																																				
B18	2	A18	18																																																																																				
B17	3	A17	19																																																																																				
B16	4	A16	20																																																																																				
B15	5	A15	21																																																																																				
B14	6	A14	22																																																																																				
B13	7	A13	23																																																																																				
B12	8	A12	24																																																																																				
B11	9	A11	25																																																																																				
B10	10	A10	26																																																																																				
B09	11	A09	27																																																																																				
B08	12	A08	28																																																																																				
B07	13	A07	29																																																																																				
B06	14	A06	30																																																																																				
B05	15	A05	31																																																																																				
B04	NC	A04	NC																																																																																				
B03	NC	A03	NC																																																																																				
B02	DC12/	A02	COM																																																																																				
B01	24V	A01	COM																																																																																				

9.3.7 64 point transistor output module (sink type)

Spec.		Module type	Transistor output module								
			XGQ-TR8A								
Output point			64 points								
Insulation system			Photo coupler insulation								
Rated load voltage			DC 12 / 24V								
Operating load voltage range			DC 10.2 ~ 26.4V								
Max. load current			0.1A / 1point, 2A / 1COM								
Leakage current at Off			0.1mA and lower								
Max. inrush current			0.7A / 10 ms and lower								
Max. voltage drop at On			DC 0.2V and lower								
Surge killer			Zener diode								
Response time	Off → On		1 ms and shorter								
	On → Off		1 ms and shorter (Rated load, resistance load)								
Common method			16 point/ 1COM								
Current consumption			230mA (when every point is On)								
Common method			32 points / COM								
External power supply	Voltage		DC12/24V ± 10% (4 Vp-p and lower ripple voltage)								
	Current		10mA and lower (if connected to DC24V)								
Operation display			LED On with Input On (32point LED on by switching)								
External connection method			40 Pin Connector × 2								
Suitable cable size			0.3 mm <sup>2</sup>								
Weight			0.15 kg								
Circuit diagram			No	Contact	No	Contact	No	Contact	No	Contact	
<p>A: displaying 0~31 B: displaying 32~63</p> <p>*COM : 1A02, 1A01 2A02, 2A01</p>		1B20	0	1A20	16	2B20	32	2A20	48		
		1B19	1	1A19	17	2B19	33	2A19	49		
		1B18	2	1A18	18	2B18	34	2A18	50		
		1B17	3	1A17	19	2B17	35	2A17	51		
		1B16	4	1A16	20	2B16	36	2A16	52		
		1B15	5	1A15	21	2B15	37	2A15	53		
		1B14	6	1A14	22	2B14	38	2A14	54		
		1B13	7	1A13	23	2B13	39	2A13	55		
		1B12	8	1A12	24	2B12	40	2A12	56		
		1B11	9	1A11	25	2B11	41	2A11	57		
		1B10	10	1A10	26	2B10	42	2A10	58		
		1B09	11	1A09	27	2B09	43	2A09	59		
		1B08	12	1A08	28	2B08	44	2A08	60		
		1B07	13	1A07	29	2B07	45	2A07	61		
		1B06	14	1A06	30	2B06	46	2A06	62		
		1B05	15	1A05	31	2B05	47	2A05	63		
1B04	NC	1A04	NC	2B04	NC	2A04	NC				
1B03	NC	1A03	NC	2B03	NC	2A03	NC				
1B02	12/24	1A02	COM1	2B02	12/24	2A02	COM2				
1B01	VDC	1A01		2B01		VDC		2A01			

9.3.8 16 point transistor output module (source type)

Module type		Transistor output module	
Spec.		XGQ-TR2B	
Output point	16 points		
Insulation method	Photo coupler insulation		
Rated load voltage	DC 12 / 24V		
Operating load voltage range	DC 10.2 ~ 26.4V		
Max. load current	0.5A / 1point, 4A / 1COM		
Leakage current at Off	0.1mA and lower		
Max. inrush current	4A / 10 ms and lower		
Max. voltage drop at On	DC 0.3V AND LOWER		
Surge killer	Zener diode		
Fuse	4A $\times$ 2(not replaceable)(Fuse cap.:50A)		
Fuse disconnection display	Yes(If a fuse is burnt out, it transfers a signal to CPU and LED is on)		
Response time	Off $\rightarrow$ On	1 ms and shorter	
	On $\rightarrow$ Off	1 ms and shorter (Rated load, resistance load)	
Common method	16 point/ 1COM		
Current consumption	70mA (when every point is On)		
External power supply	Voltage	DC12/24V $\pm$ 10% (4 Vp-p and lower ripple voltage)	
	Current	10mA and lower (if connected to DC24V)	
Operation display	LED On with output On		
External connection method	18point Terminal strip connector		
Weight	0.12kg		
Circuit diagram			
		Terminal block	Contact
		TB1	0
		TB2	1
		TB3	2
		TB4	3
		TB5	4
		TB6	5
		TB7	6
		TB8	7
		TB9	8
		TB10	9
		TB11	10
		TB12	11
		TB13	12
		TB14	13
		TB15	14
		TB16	15
		TB17	COM
TB18	0V		



9.3.9 32 point transistor output module (source type)

Module type		Transistor output module			
Spec.		XGQ-TR4B			
Output point		32 points			
Insulation method		Photo coupler insulation			
Rated load voltage		DC 12 / 24V			
Operating load voltage range		DC 10.2 ~ 26.4V			
Max. load current		0.1A / 1point, 2A / 1COM			
Leakage current at Off		0.1mA and lower			
Max. inrush current		4A / 10 ms and lower			
Max. voltage drop at On		DC 0.3V AND LOWER			
Surge killer		Zener diode			
Response time	Off → On	1 ms and shorter			
	On → Off	1 ms and shorter (Rated load, resistance load)			
Common method		32points / 1COM			
Current consumption		130mA (when every point is On)			
External power supply	Voltage	DC12/24V ± 10% (4 Vp-p and lower ripple voltage)			
	Current	10mA and lower (if connected to DC24V)			
Operation display		LED On with Input On			
External connection method		40 Pin Connector			
Suitable cable size		0.3 mm <sup>2</sup>			
Weight		0.1 kg			
Circuit diagram					
		* COM : B02, B01			
No	Contact	No	Contact		
B20	0	A20	16		
B19	1	A19	17		
B18	2	A18	18		
B17	3	A17	19		
B16	4	A16	20		
B15	5	A15	21		
B14	6	A14	22		
B13	7	A13	23		
B12	8	A12	24		
B11	9	A11	25		
B10	10	A10	26		
B09	11	A09	27		
B08	12	A08	28		
B07	13	A07	29		
B06	14	A06	30		
B05	15	A05	31		
B04	NC	A04	NC		
B03	NC	A03	NC		
B02	COM	A02	0V		
B01	COM	A01	0V		

9.3.10 64 point transistor output module (source type)

Spec.		Module type	Transistor output module							
			XGQ-TR8B							
Output point		64 points								
Insulation method		Photo coupler insulation								
Rated load voltage		DC 12 / 24V								
Operating load voltage range		DC 10.2 ~ 26.4V								
Max. load current		0.1A / 1point, 2A / 1COM								
Leakage current at Off		0.1mA and lower								
Max. inrush current		4A / 10 ms and lower								
Max. voltage drop at On		DC 0.3V and lower								
Surge killer		Zener diode								
Response time	Off → On	1 ms and shorter								
	On → Off	1 ms and shorter (Rated load, resistance load)								
Common method		32point / 1COM								
Current consumption		230mA (when every point is On)								
Common method		32point / COM								
External power supply	Voltage	DC12/24V ± 10% (4 Vp-p and lower ripple voltage)								
	Current	10mA and lower (if connected to DC24V)								
Operation display		LED On with Input On (32 point LED ON by switching)								
External connection method		40 Pin Connector × 2								
Suitable cable size		0.3 mm <sup>2</sup>								
Weight		0.15 kg								
Circuit diagram										
		No	Contact	No	Contact	No	Contact	No	Contact	
		1B20	0	1A20	16	2B20	32	2A20	48	
		1B19	1	1A19	17	2B19	33	2A19	49	
		1B18	2	1A18	18	2B18	34	2A18	50	
		1B17	3	1A17	19	2B17	35	2A17	51	
		1B16	4	1A16	20	2B16	36	2A16	52	
		1B15	5	1A15	21	2B15	37	2A15	53	
		1B14	6	1A14	22	2B14	38	2A14	54	
		1B13	7	1A13	23	2B13	39	2A13	55	
		1B12	8	1A12	24	2B12	40	2A12	56	
		1B11	9	1A11	25	2B11	41	2A11	57	
		1B10	10	1A10	26	2B10	42	2A10	58	
		1B09	11	1A09	27	2B09	43	2A09	59	
		1B08	12	1A08	28	2B08	44	2A08	60	
		1B07	13	1A07	29	2B07	45	2A07	61	
		1B06	14	1A06	30	2B06	46	2A06	62	
		1B05	15	1A05	31	2B05	47	2A05	63	
		1B04	NC	1A04	NC	2B04	NC	2A04	NC	
		1B03	NC	1A03	NC	2B03	NC	2A03	NC	
		1B02	COM	1A02	0V	2B02	COM	2A02	0V	
		1B01	COM	1A01	0V	2B01	COM	2A01	0V	
										B20 ○ ○ ○ A20 B19 ○ ○ ○ A19 B18 ○ ○ ○ A18 B17 ○ ○ ○ A17 B16 ○ ○ ○ A16 B15 ○ ○ ○ A15 B14 ○ ○ ○ A14 B13 ○ ○ ○ A13 B12 ○ ○ ○ A12 B11 ○ ○ ○ A11 B10 ○ ○ ○ A10 B09 ○ ○ ○ A09 B08 ○ ○ ○ A08 B07 ○ ○ ○ A07 B06 ○ ○ ○ A06 B05 ○ ○ ○ A05 B04 ○ ○ ○ A04 B03 ○ ○ ○ A03 B02 ○ ○ ○ A02 B01 ○ ○ ○ A01

9.3.11 8 point transistor isolated output module

Module type		Transistor output module																																						
Spec.		XGQ-TR1C																																						
Output point		8 points																																						
Insulation method		Photo coupler insulation																																						
Rated load voltage		DC 12 / 24V																																						
Operating load voltage range		DC 10.2 ~ 26.4V																																						
Max. load current		2A / 1 point																																						
Leakage current at Off		0.1mA and lower																																						
Max. inrush current		4A / 10 ms and lower																																						
Max. voltage drop at On		DC 0.3V and lower																																						
Surge killer		Zener diode																																						
Response time	Off → On	3 ms and shorter																																						
	On → Off	10 ms and shorter (Rated load, resistance load)																																						
Common method		1 point/ 1COM																																						
Current consumption		100mA (when every points On)																																						
External power supply	Voltage	DC12/24V ± 10% (4 Vp-p and lower ripple voltage)																																						
	Current	10mA and lower (if connected to DC24V)																																						
Operation display		LED On with output On																																						
External connection method		18point Terminal strip connector																																						
Weight		0.11kg																																						
Circuit diagram																																								
		<table border="1"> <thead> <tr> <th>Terminal block</th> <th>Contact</th> </tr> </thead> <tbody> <tr><td>TB1</td><td>P0</td></tr> <tr><td>TB2</td><td>COM0</td></tr> <tr><td>TB3</td><td>P1</td></tr> <tr><td>TB4</td><td>COM1</td></tr> <tr><td>TB5</td><td>P2</td></tr> <tr><td>TB6</td><td>COM2</td></tr> <tr><td>TB7</td><td>P3</td></tr> <tr><td>TB8</td><td>COM3</td></tr> <tr><td>TB9</td><td>P4</td></tr> <tr><td>TB10</td><td>COM4</td></tr> <tr><td>TB11</td><td>P5</td></tr> <tr><td>TB12</td><td>COM5</td></tr> <tr><td>TB13</td><td>P6</td></tr> <tr><td>TB14</td><td>COM6</td></tr> <tr><td>TB15</td><td>P7</td></tr> <tr><td>TB16</td><td>COM7</td></tr> <tr><td>TB17</td><td>NC</td></tr> <tr><td>TB18</td><td>NC</td></tr> </tbody> </table>	Terminal block	Contact	TB1	P0	TB2	COM0	TB3	P1	TB4	COM1	TB5	P2	TB6	COM2	TB7	P3	TB8	COM3	TB9	P4	TB10	COM4	TB11	P5	TB12	COM5	TB13	P6	TB14	COM6	TB15	P7	TB16	COM7	TB17	NC	TB18	NC
Terminal block	Contact																																							
TB1	P0																																							
TB2	COM0																																							
TB3	P1																																							
TB4	COM1																																							
TB5	P2																																							
TB6	COM2																																							
TB7	P3																																							
TB8	COM3																																							
TB9	P4																																							
TB10	COM4																																							
TB11	P5																																							
TB12	COM5																																							
TB13	P6																																							
TB14	COM6																																							
TB15	P7																																							
TB16	COM7																																							
TB17	NC																																							
TB18	NC																																							

9.4 Digital I/O Module Specifications

9.4.1 32 point (DC input - transistor output) I/O combined module

XGH-DT4A			
Input		Output	
Input point	16 points	Output point	16 points
Insulation method	Photo coupler insulation	Insulation method	Photo coupler insulation
Rated input voltage	DC 24V	Rated load voltage	DC 12 / 24V
Rated input current	Approx. 4 mA	Operating load voltage range	DC 10.2 ~ 26.4V
Operating voltage range	DC20.4~28.8V (5% and lower ripple rate )	Max. load current	0.1A / 1point, 1.6A / 1COM
Withstand voltage	AC560Vrms/3Cycle(altitude2000m)	Leakage current at Off	0.1mA and lower
On voltage/On current	DC 19V and higher / 3mA and higher	Max. inrush current	0.7A / 10 ms and lower
Off voltage/Off current	DC 11V and lower / 1.7mA and lower	Surge killer	Zener diode
Input resistance	Approx. 5.6 kΩ	Max. voltage drop at On	DC 0.2V and lower
Response time	Off → On	Response time	Off → On
	On → Off		On → Off
Common method	16 point/ COM	Common method	16 point/ 1COM
Operation display	LED On with input On	Operation display	LED On with output On
Current consumption(mA)	110mA (when ever point is on)		
External connection method	40 Pin Connector × 1		
Weight	0.1 kg		

External connection

**Input**

\* COM : B02, B01

No	Contact	No	Contact
B20	0	A20	16
B19	1	A19	17
B18	2	A18	18
B17	3	A17	19
B16	4	A16	20
B15	5	A15	21
B14	6	A14	22
B13	7	A13	23
B12	8	A12	24
B11	9	A11	25
B10	10	A10	26
B09	11	A09	27
B08	12	A08	28
B07	13	A07	29
B06	14	A06	30
B05	15	A05	31
B04	NC	A04	DC12 /24V
B03	NC	A03	
B02	COM	A02	0V
B01		A01	

**Output**

9.5 Event Input Module

9.5.1 Event Input Module (Source/Sink type)

Specification		XGF-SOEA
Input point		32 point
Insulation method		Photo coupler insulation
Memory size		Records 1Mbit event information (300 event information per XGF-SOEA module)
Precision		1 ms (±2ms : error between modules)
Rated input voltage		DC24V
Rated input current		About 4mA
Used voltage range		DC20.4 ~ 28.8V (within ripple rate 5%)
On voltage/On current		DC19V or above / 3 mA or above
Off voltage/ Off current		DC11V or less / 1.7 mA or less
Input resistance		About 5.6 kΩ
Response time	Off → On	HW delay (10μs: Normal) + input filter time (user setting: 0~100ms) + CPU scan time delay (50μs)
	On → Off	HW delay (84μs: Normal) + input filter time (user setting: 0~100ms) + CPU scan time delay (50μs)
Working voltage		AC560V rms/3 Cycle (Altitude 2000m)
Insulation resistance		Insulation resistance 10 MΩ or above (DC500V)
COMM method		32 point / COM
Current consumption (A)		0.7(MAX)
Operation indicator		LED is on when input is on
External connection method		40 pin connector
Size		27x98x90
Weight		0.2 kg

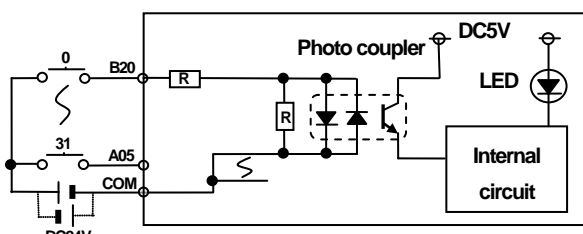
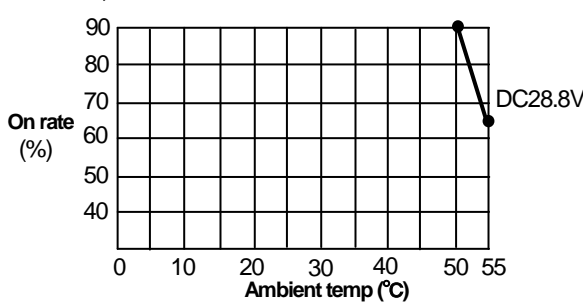
Circuit configuration		No	Contact	No	Contact
 <p>* COM : B02, B01</p>  <p>On rate (%)</p> <p>Ambient temp (°C)</p> <p>Derating diagram</p>	B20	0	A20	16	
	B19	1	A19	17	
	B18	2	A18	18	
	B17	3	A17	19	
	B16	4	A16	20	
	B15	5	A15	21	
	B14	6	A14	22	
	B13	7	A13	23	
	B12	8	A12	24	
	B11	9	A11	25	
	B10	10	A10	26	
	B09	11	A09	27	
	B08	12	A08	28	
	B07	13	A07	29	
	B06	14	A06	30	
	B05	15	A05	31	
	B04	RX+	A04	SG	
	B03	RX-	A03	SG	
	B02	COM	A02	COM	
	B01	COM	A01	COM	

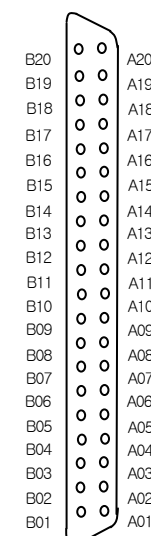

9.6 Smart Link

9.6.1 Modules accessible to Smart Link

From digital I/O modules used for XGT Series, the modules accessible to Smart Link are as follows.  
 32 point modules need a Connector(40 Pin x 1), 64 point modules need 2 connectors(40 Pin x 2)

Model	Specification	No. of Pins
XGI-D24A/B	DC input 32 point module	40 Pin Connector x 1
XGI-D28A/B	DC input 64 point module	40 Pin Connector x 2
XGQ-TR4A	TR output 32 point module(sink type)	40 Pin Connector x 1
XGQ-TR8A	TR output 64 point module(sink type)	40 Pin Connector x 2
XGQ-TR4B	TR output 32 point module(source type)	40 Pin Connector x 1
XGQ-TR8B	TR output 64 point module(source type)	40 Pin Connector x 2
XGF-SOEA	Event input module	40 Pin Connector x 1

9.6.2 Smart Link Components

The company prepares smart link products for the convenience of using our Connector type I/O modules.  
 For further information, please refer to the data sheet contained in a smart link product.  
 (Refer to 7.6.6 to confirm the differences between TG7-1H40CA and TG7-1H40S)

	Model	Cable	Length of Cable
Terminal board	TG7-1H40S	C40HF-05PB-1B	0.5m
		C40HF-10PB-1B	1m
		C40HF-15PB-1B	1.5m
		C40HF-20PB-1B	2m
		C40HF-30PB-1B	3m
	TG7-1H40CA (Common 20Pin Added)	C40HF-05PB-1B	0.5m
		C40HF-10PB-1B	1m
		C40HF-15PB-1B	1.5m
		C40HF-20PB-1B	2m
		C40HF-30PB-1B	3m
Relay board	R32C-NS5A-40P (Sink type)	C40HF-05PB-1	0.5m
		C40HF-10PB-1	1m
		C40HF-15PB-1	1.5m
		C40HF-20PB-1	2m
		C40HF-30PB-1	3m
	R32C-PS5A-40P (Source type)	C40HF-05PB-XGP1	0.5m
		C40HF-10PB-XGP1	1m
		C40HF-20PB-XGP1	2m

9.6.3 Smart Link Mapping Table

① : Module using 1ea Cable    ② : Module using 2ea Cable

LS Smart Link Mapping Table				XGT PLC (Digital I/O Module)								
				Length (m)	XGQ-TR4A	XGQ-TR4B	XGQ-TR8A	XGQ-TR8B	XGI-D24A	XGI-D24B	XGI-D28A	XGI-D28B
	Cable	Description	Sets	1	1	2	2	1	1	2	2	1
TG7-1H40S /TG7-1H40CA	C40HF-05PB-1B	PLC,CABLE ASS'Y,40p-40p,0.5m	0.5	①	①	②	②	①	①	②	②	①
	C40HF-10PB-1B	PLC,CABLE ASS'Y,40p-40p,1m	1.0	①	①	②	②	①	①	②	②	①
	C40HF-15PB-1B	PLC,CABLE ASS'Y,40p-40p,1.5m	1.5	①	①	②	②	①	①	②	②	①
	C40HF-20PB-1B	PLC,CABLE ASS'Y,40p-40p,2m	2.0	①	①	②	②	①	①	②	②	①
	C40HF-30PB-1B	PLC,CABLE ASS'Y,40p-40p,3m	3.0	①	①	②	②	①	①	②	②	①
R32C-NSSA-40P (SINK)	C40HF-05PB-1	PLC,CABLE ASS'Y,40p-40p,0.5m	0.5	①		②						
	C40HF-10PB-1	PLC,CABLE ASS'Y,40p-40p,1m	1.0	①		②						
	C40HF-15PB-1	PLC,CABLE ASS'Y,40p-40p,1.5m	1.5	①		②						
	C40HF-20PB-1	PLC,CABLE ASS'Y,40p-40p,2m	2.0	①		②						
	C40HF-30PB-1	PLC,CABLE ASS'Y,40p-40p,3m	3.0	①		②						
R32C-PSSA-40P (Source)	C40HF-05PB-XGP1	PLC,CABLE ASS'Y,40p-40p,0.5m	0.5		①		②					
	C40HF-10PB-XGP1	PLC,CABLE ASS'Y,40p-40p,1m	1.0		①		②					
	C40HF-15PB-XGP1	PLC,CABLE ASS'Y,40p-40p,1.5m	1.5									
	C40HF-20PB-XGP1	PLC,CABLE ASS'Y,40p-40p,2m	2.0		①		②					
	C40HF-30PB-XGP1	PLC,CABLE ASS'Y,40p-40p,3m	3.0									

9.6.4 Smart Link Connection

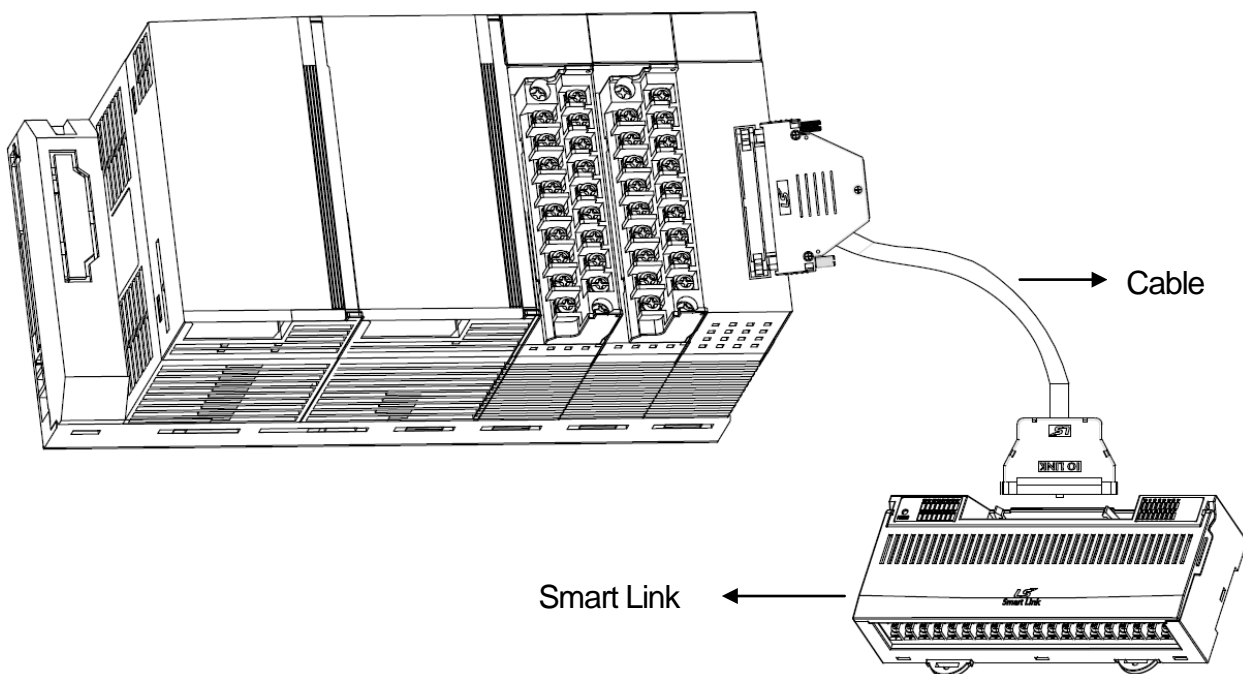

9.6.5 Smart Link Connection Diagram

(1) XGI-D24A/B

1) Applicable Smart Link

	Model	Cable	Length of Cable
Terminal board	TG7-1H40S	C40HF-05PB-1B	0.5m
		C40HF-10PB-1B	1m
		C40HF-15PB-1B	1.5m
		C40HF-20PB-1B	2m
		C40HF-30PB-1B	3m
	TG7-1H40CA (Common 20Pin Added)	C40HF-05PB-1B	0.5m
		C40HF-10PB-1B	1m
		C40HF-15PB-1B	1.5m
		C40HF-20PB-1B	2m
		C40HF-30PB-1B	3m

2) Connection Diagram (XGI-D24A/B)

(a) TG7-1H40S

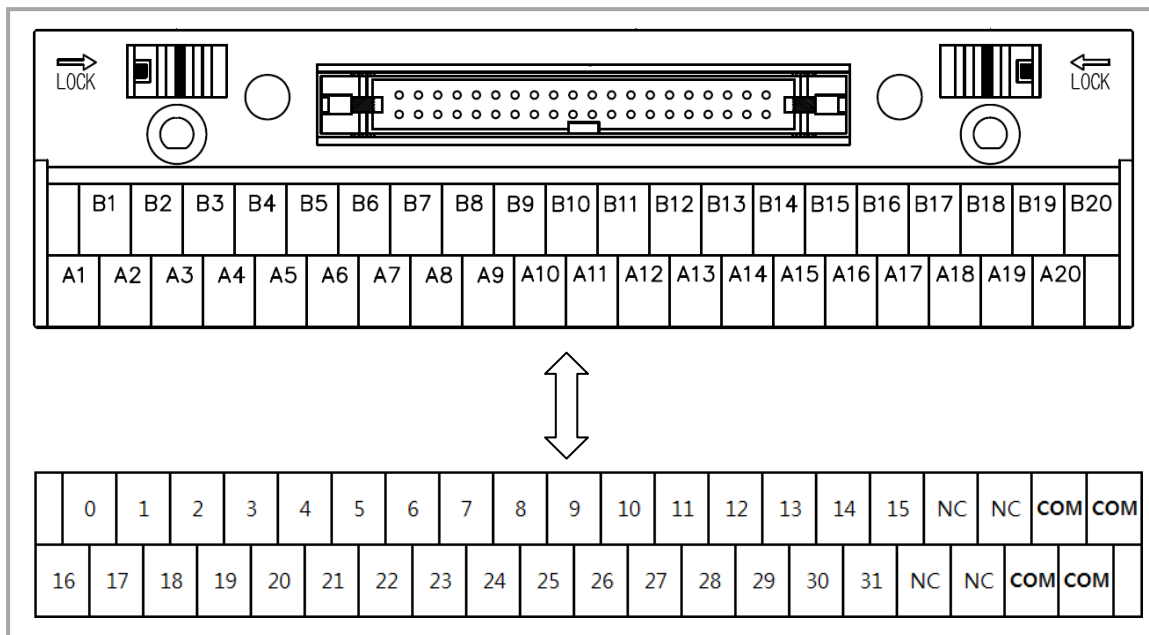



(b) TG7-1H40CA

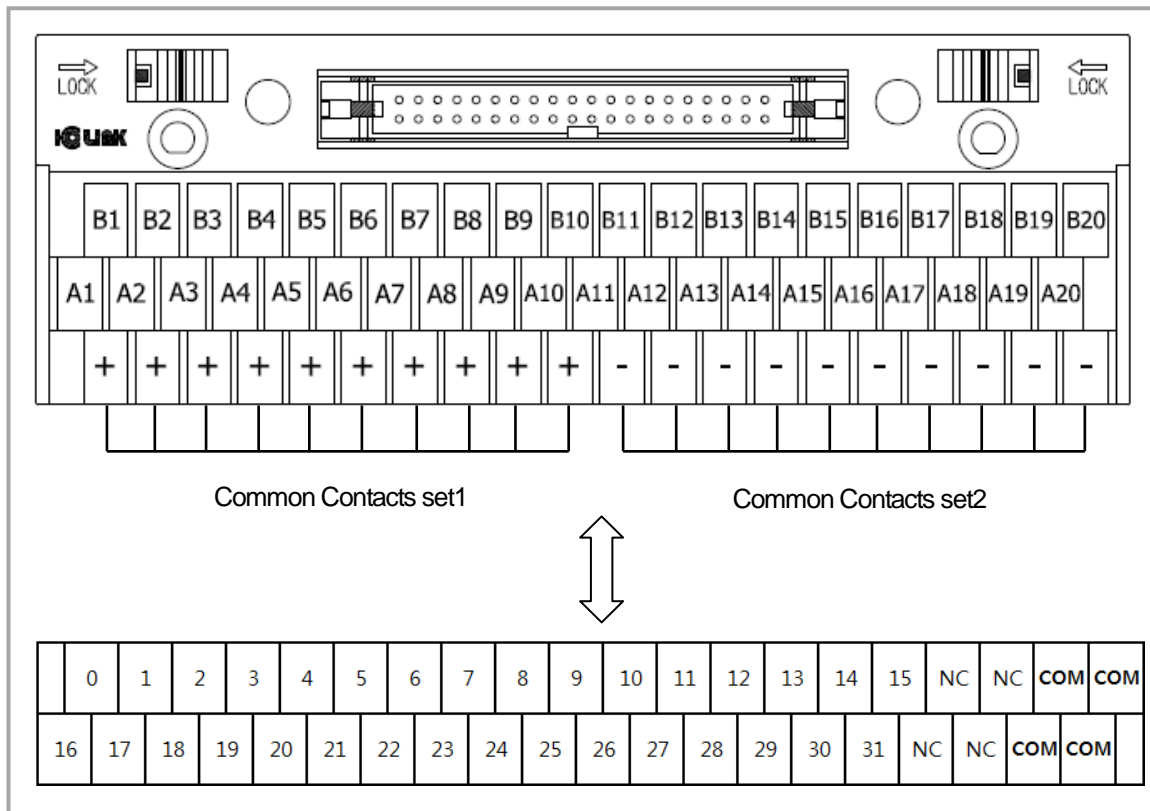

(2) XGI-D28A/B

1) Applicable Smart Link

	Model	Cable	Length of Cable
Terminal board	TG7-1H40S	C40HF-05PB-1B	0.5m
		C40HF-10PB-1B	1m
		C40HF-15PB-1B	1.5m
		C40HF-20PB-1B	2m
		C40HF-30PB-1B	3m
	TG7-1H40CA (Common 20Pin Added)	C40HF-05PB-1B	0.5m
		C40HF-10PB-1B	1m
		C40HF-15PB-1B	1.5m
		C40HF-20PB-1B	2m
		C40HF-30PB-1B	3m

2) Connection Diagram (XGI-D28A/B)

(a) TG7-1H40S

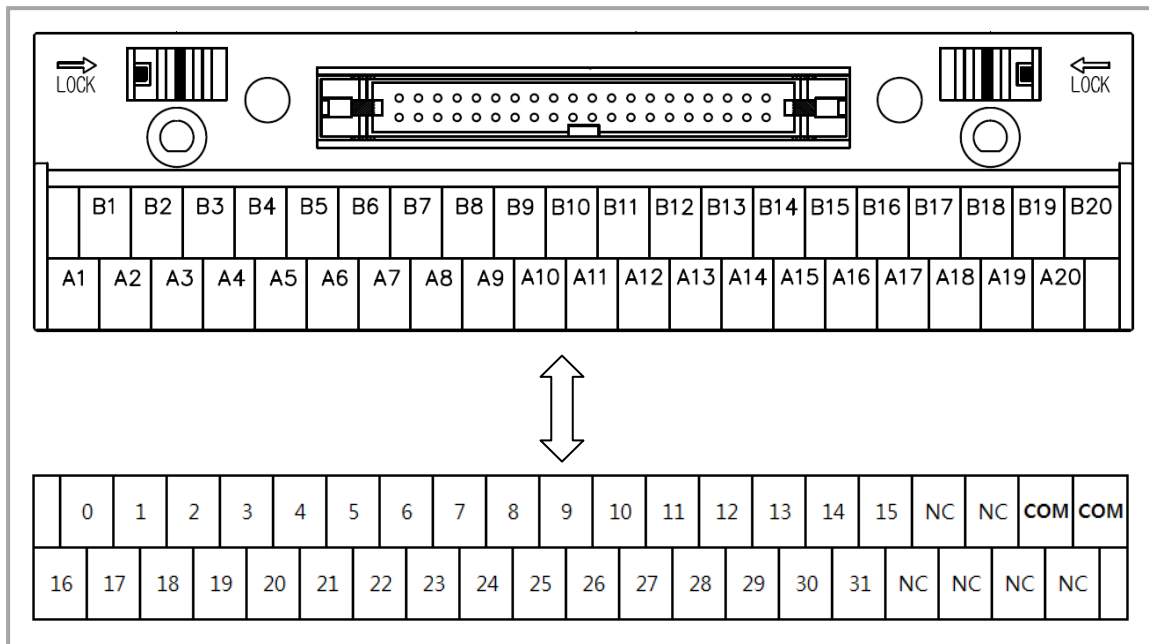

(b) TG7-1H40CA

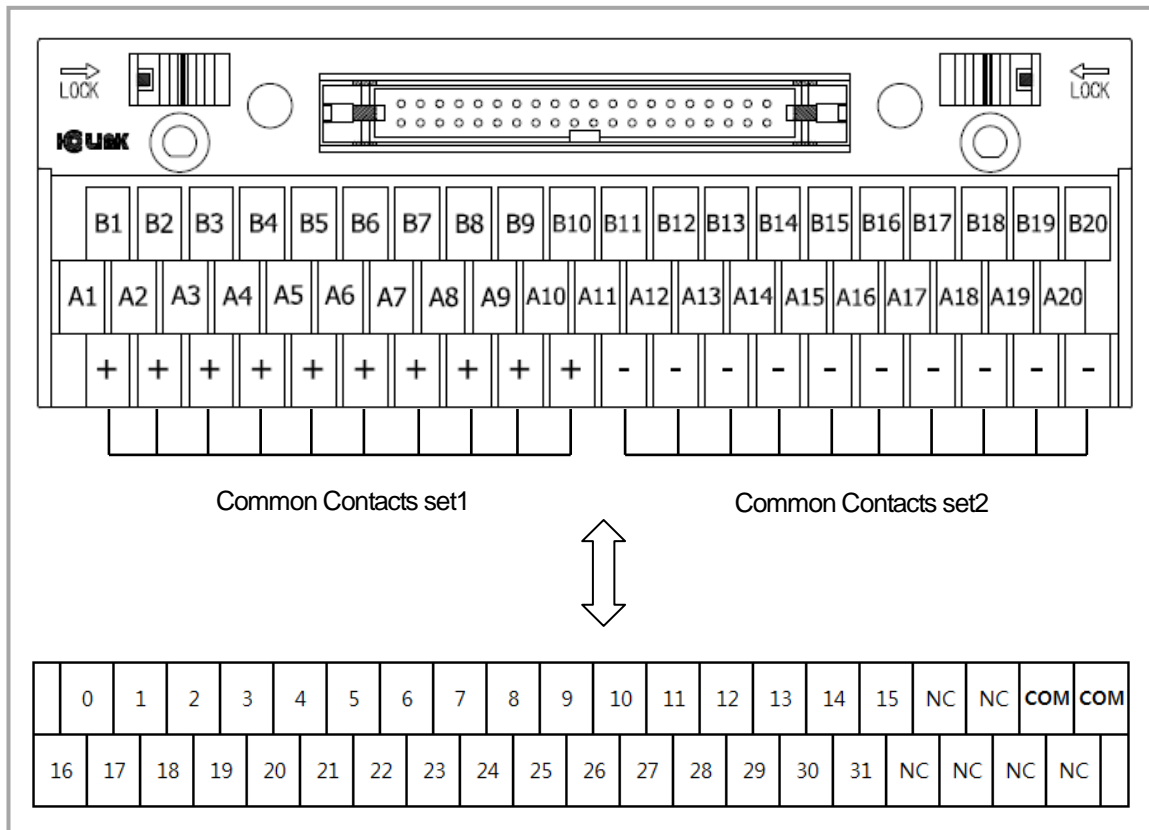

(3) XGQ-TR4A/8A

1) Applicable Smart Link

	Model	Cable	Length of Cable
Terminal board	TG7-1H40S	C40HF-05PB-1B	0.5m
		C40HF-10PB-1B	1m
		C40HF-15PB-1B	1.5m
		C40HF-20PB-1B	2m
		C40HF-30PB-1B	3m
	TG7-1H40CA (Common 20Pin Added)	C40HF-05PB-1B	0.5m
		C40HF-10PB-1B	1m
		C40HF-15PB-1B	1.5m
		C40HF-20PB-1B	2m
		C40HF-30PB-1B	3m
Relay board	R32C-NS5A-40P (Sink type)	C40HF-05PB-1	0.5m
		C40HF-10PB-1	1m
		C40HF-15PB-1	1.5m
		C40HF-20PB-1	2m
		C40HF-30PB-1	3m

2) Connection Diagram (XGQ-TR4A/8A)

(a) TG7-1H40S

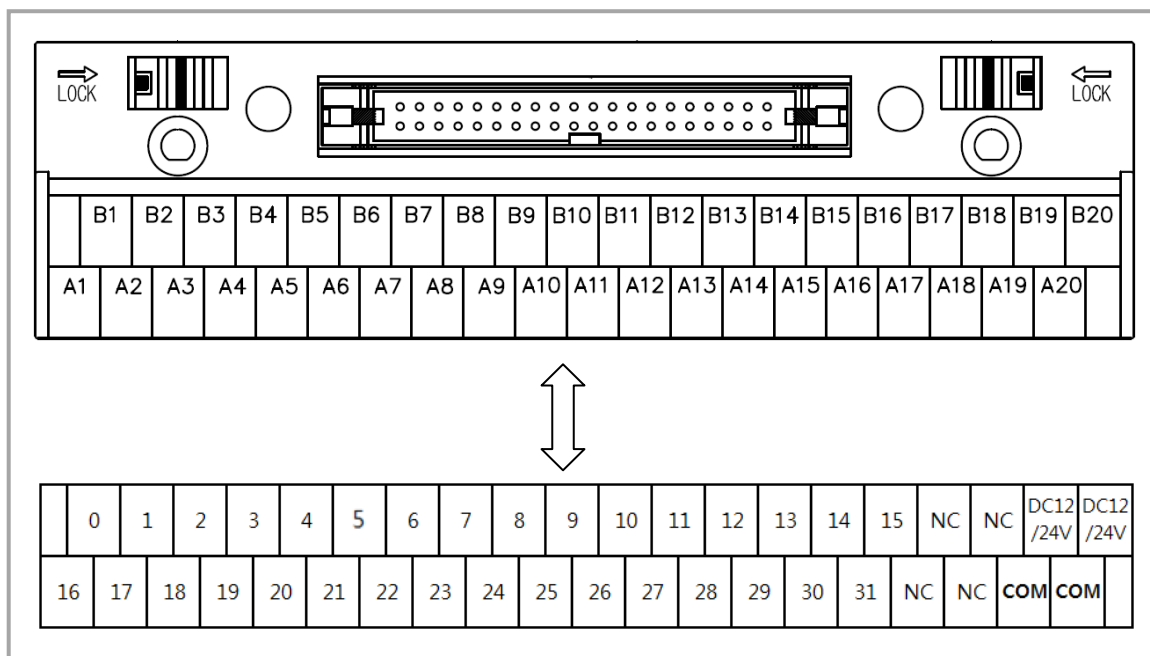

(b) TG7-1H40CA

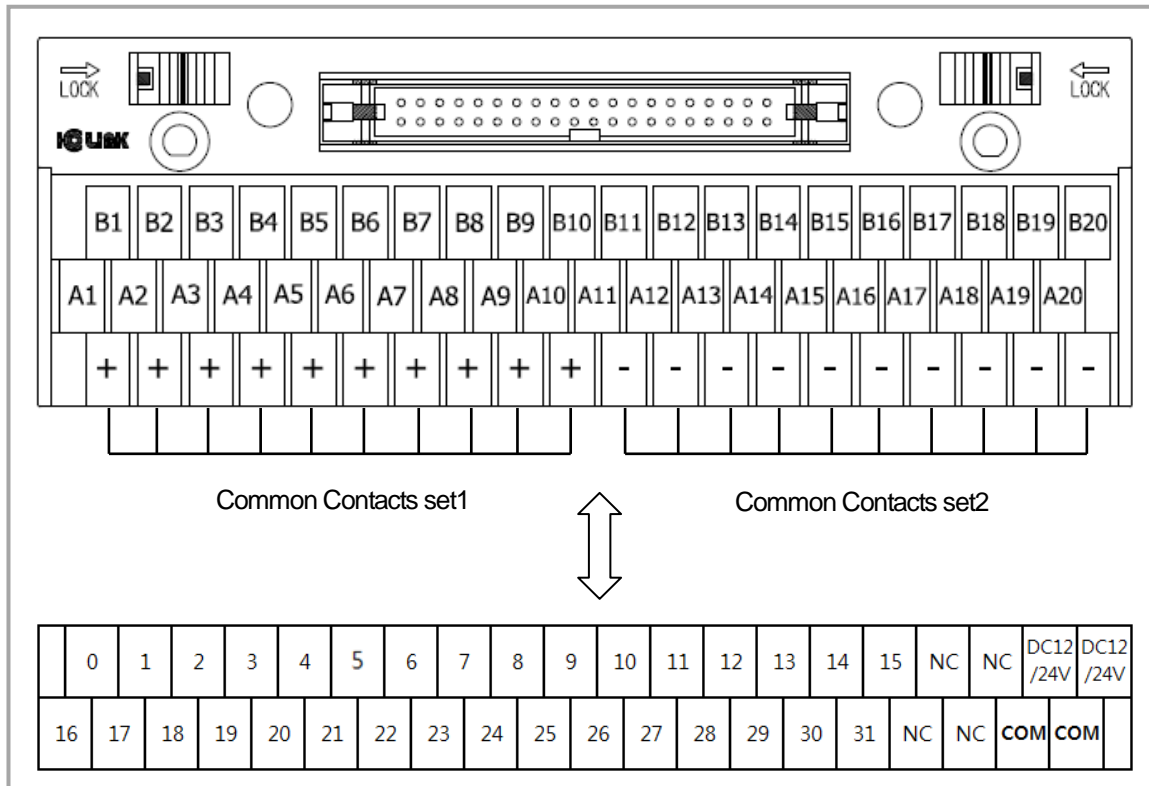

(c) R32C-NS5A-40P

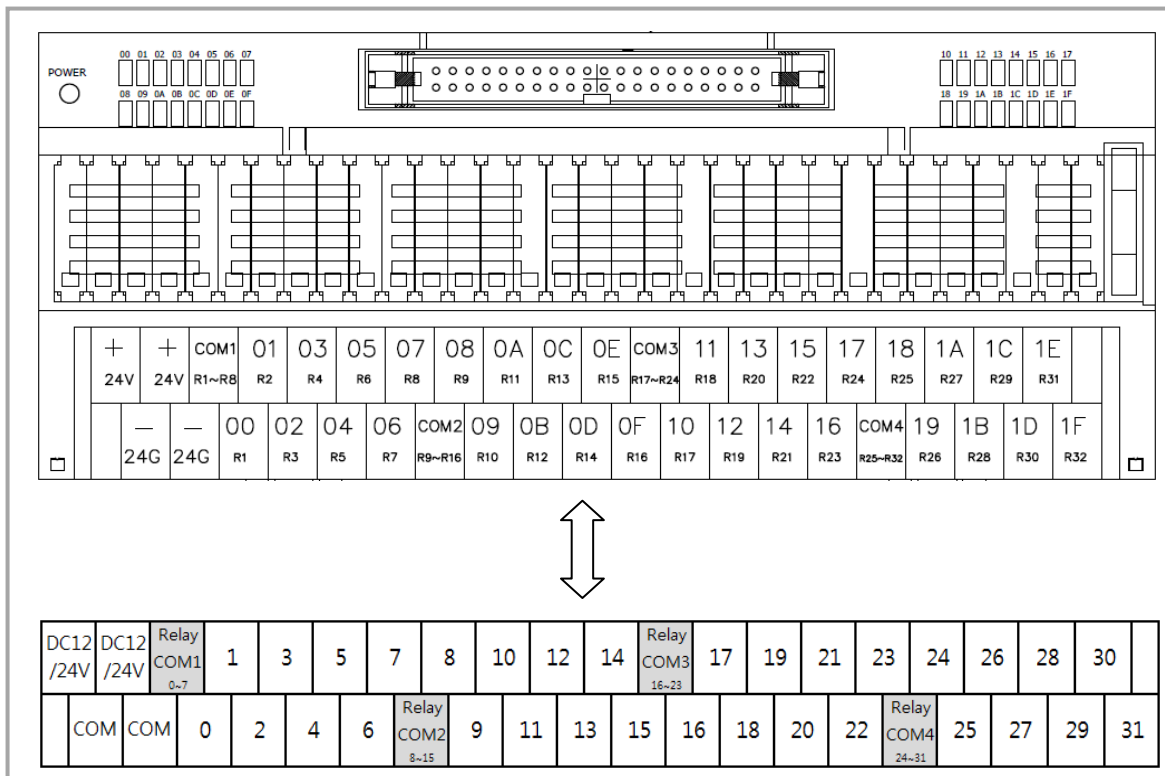

(4) XGQ-TR4B/8B

1) Applicable Smart Link

	Model	Cable	Length of Cable
Terminal board	TG7-1H40S	C40HF-05PB-1B	0.5m
		C40HF-10PB-1B	1m
		C40HF-15PB-1B	1.5m
		C40HF-20PB-1B	2m
		C40HF-30PB-1B	3m
	TG7-1H40CA (Common 20Pin Added)	C40HF-05PB-1B	0.5m
		C40HF-10PB-1B	1m
		C40HF-15PB-1B	1.5m
		C40HF-20PB-1B	2m
		C40HF-30PB-1B	3m
Relay board	R32C-PS5A-40P (Source type)	C40HF-05PB-XGP1	0.5m
		C40HF-10PB-XGP1	1m
		C40HF-20PB-XGP1	2m
		-	-
		-	-

2) Connection Diagram (XGQ-TR4B/8B)

(a) TG7-1H40S

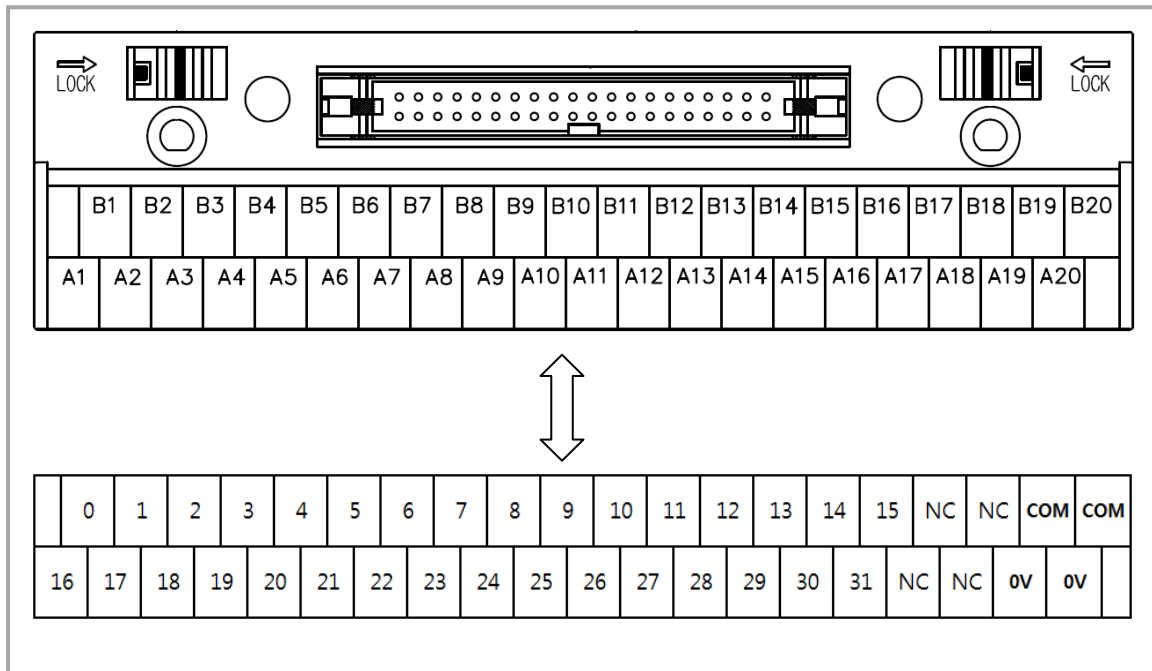

(b) TG7-1H40CA

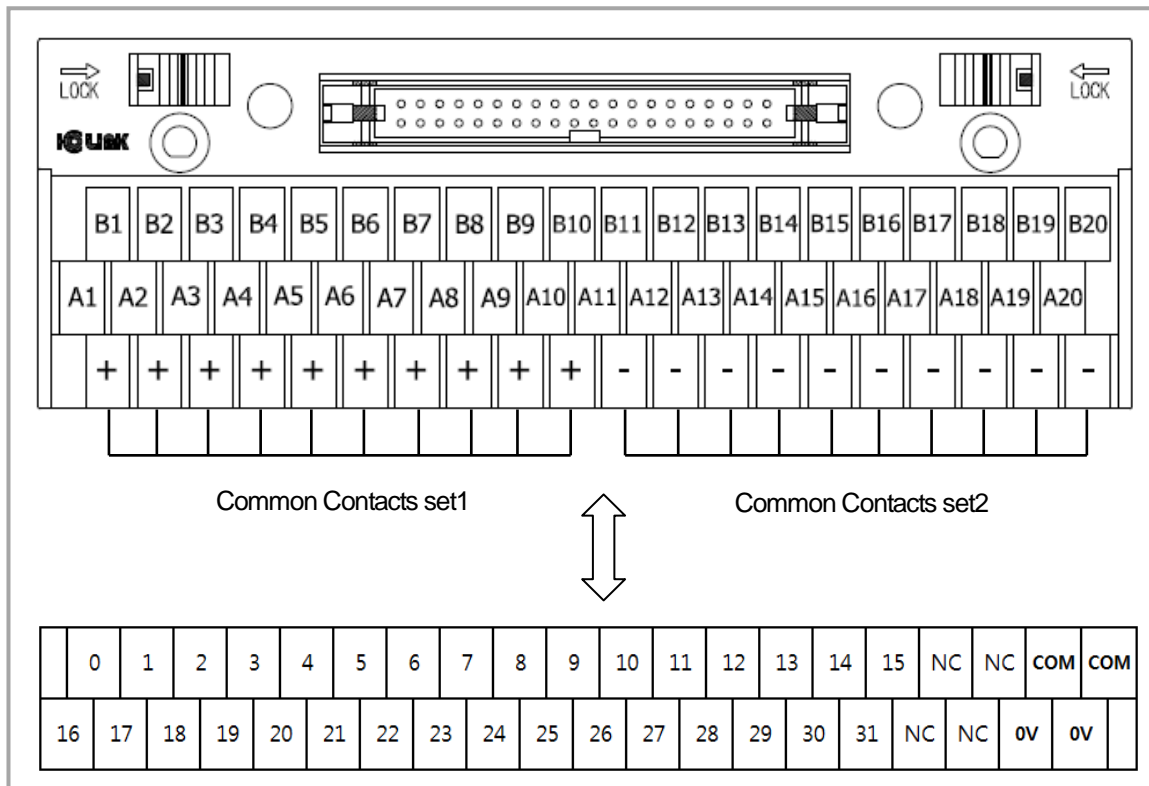

(c) R32C-PS5A-40P

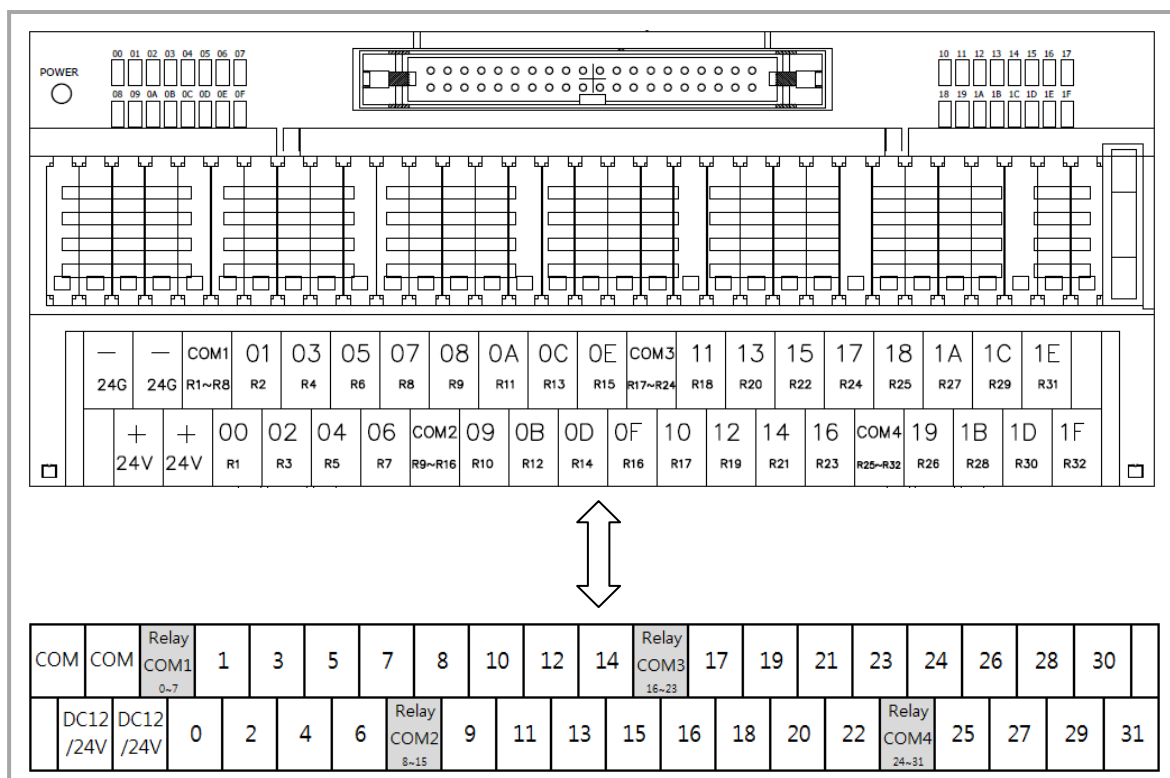

(5) XGF-SOEA

1) Applicable Smart Link

	Model	Cable	Length of Cable
Terminal board	TG7-1H40S	C40HF-05PB-1B	0.5m
		C40HF-10PB-1B	1m
		C40HF-15PB-1B	1.5m
		C40HF-20PB-1B	2m
		C40HF-30PB-1B	3m
	TG7-1H40CA (Common 20Pin Added)	C40HF-05PB-1B	0.5m
		C40HF-10PB-1B	1m
		C40HF-15PB-1B	1.5m
		C40HF-20PB-1B	2m
		C40HF-30PB-1B	3m

2) Connection Diagram (XGF-SOEA)

(a) TG7-1H40S

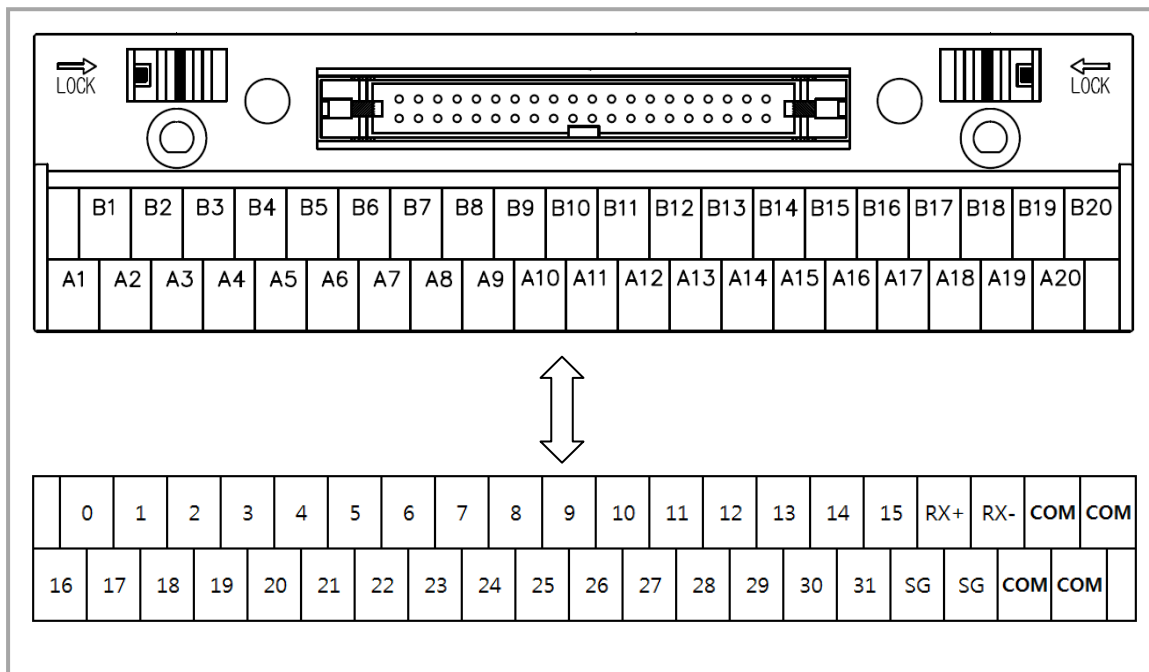



(b) TG7-1H40CA

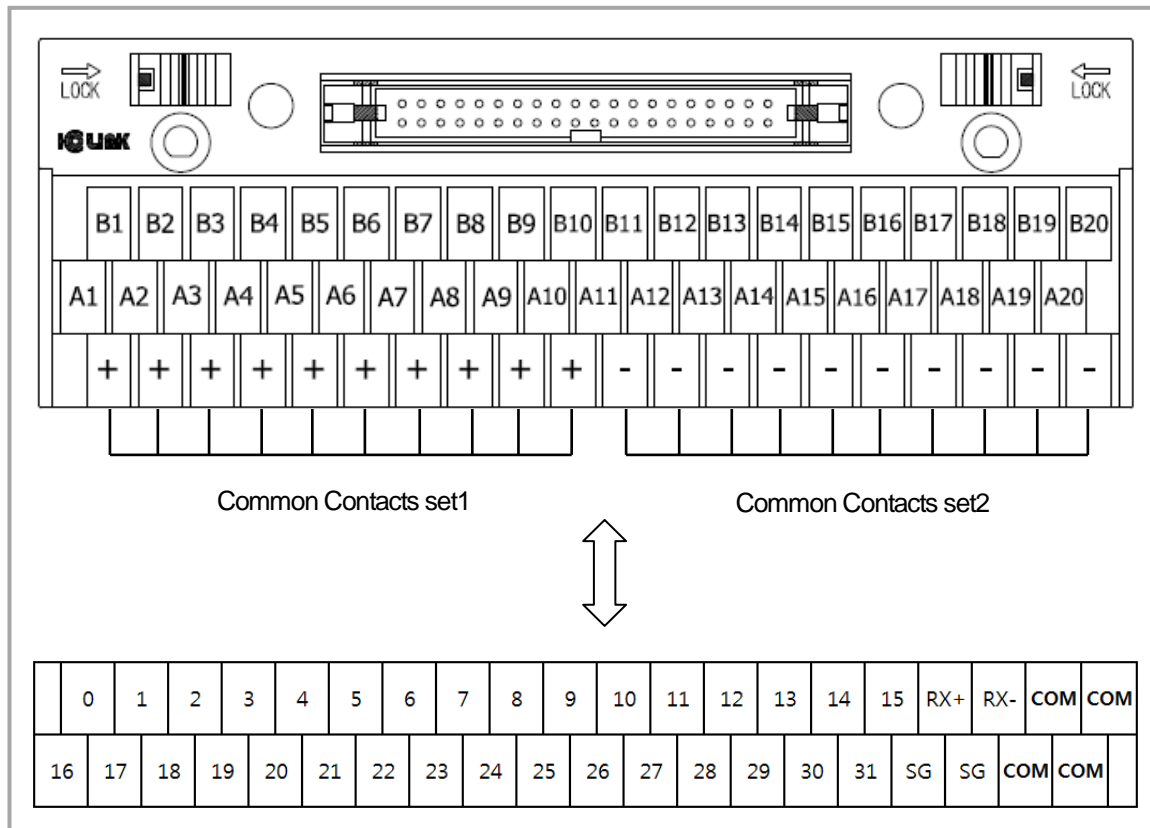

9.6.6 Smart Link Specifications & Dimensions

(1) TG7-1H40S

1) Specifications

Rated Voltage	AC, DC 125V
Rated Current	1A
Withstanding Voltage	600V 1min
Insulation resistance	100MΩ (DC 500V)
Applicable Wire	1.25 mm <sup>2</sup> /MAX
T/B Screw	M3 X 10L
Screw Torque	1.2N • m(12Kgf • cm)
Case	Modified PPO(Noryl)(UL 94V-0)

2) Dimensions(mm)

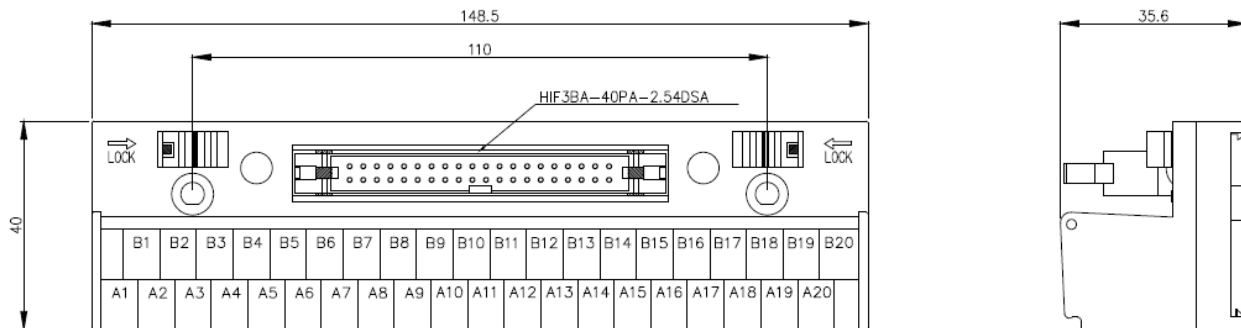

(2) TG7-1H40CA

1) Specifications

Rated Voltage		125V AC / 24V DC
Rated Current	IO	1A
	Common	10A (Total)
Insulation resistance		100MΩ (DC 500V)
Withstanding Voltage		AC500V 1min
Applicable Wire		AWG22-16 (MAX / 1.5 mm <sup>2</sup> )
Contact Screw		M3 X 10L
Screw Torque		1.2N • m(12Kgf • cm)
Ambient Temperature		-10°C ~ +50°C (Non-condensing)
Terminal Block & Cover		Modified PPO
Protective Cover		Polycarbonate
PCB		Epoxy 1.6t

2) Dimensions(mm)

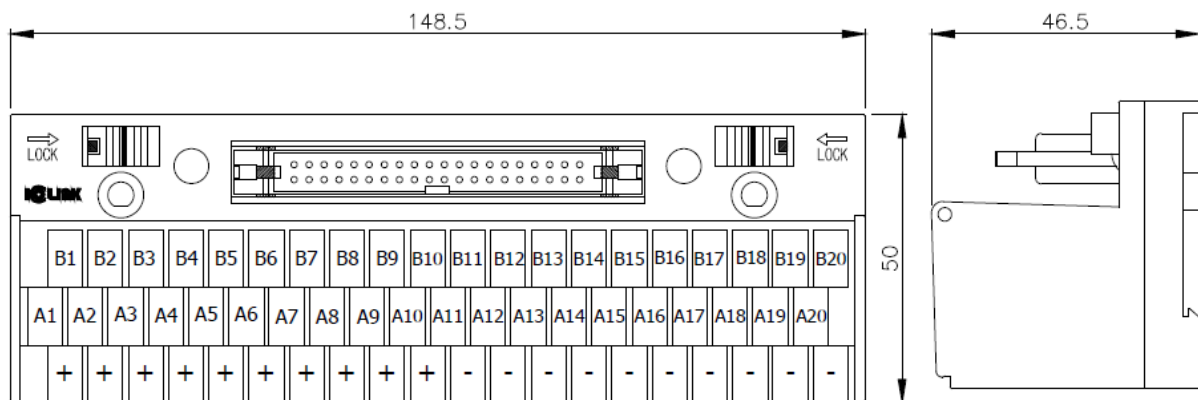

(3) R32C-N(P)S5A-40P

1) Specifications

(a) Relay Board

Case	Modified PPO
Protective Cover	Polycarbonate
PCB	Epoxy 1.6t / 2oz
Applicable Wire	AWG22-16 (MAX / 1.5 mm <sup>2</sup> )
T/B Screw	M3 X 8L
Screw Torque	1.2N • m(12Kgf • cm)
Ambient Temperature	-10°C ~ +50°C (Non-condensing)

(b) Relay

Specification		PA1a-24V
Contact	Arrangement	1a
	Nominal switching capacity	5A 250V AC / 5A 30V DC
	Max. switching current	5A
	Max. switching voltage	250V AC / 110V DC
Coil	Rated Voltage	24V DC
	Pick-up voltage	16.8V
	Drop-out voltage	1.2V DC
	Coil resistance	3,200Ω
	Rated operation power	180mW
Surge voltage between contact and coil		4,000V
Initial breakdown voltage Between contact and coil		2,000V rms

2) Dimensions(mm)

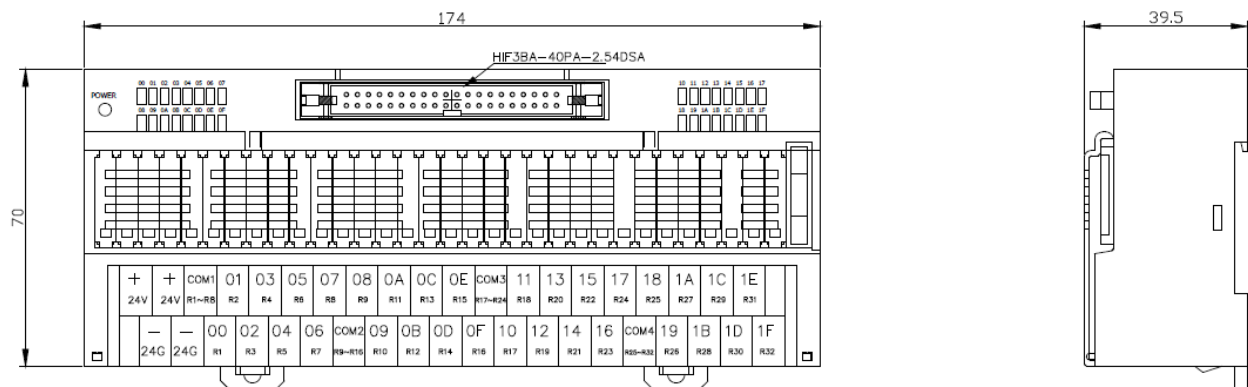

## Chapter 8 Power Module

Here describes the selection method, type and specification of power module.

### 8.1 Selection Method

The selection of power module is determined by the current that voltage and power module of input power supply to the system, that is, the sum of current consumption of digital I/O module, special module and communication module which are installed on the same base as power module.

If exceeded the rated output capacity of power module, the system does not operate normally.

In case of system configuration, consider the current consumption of each module before selecting the power module.

- For consumption current of each module, refer to user manual or data sheet of each module.

#### 1) Current consumption per module (DC 5V)

			(unit : mA)		
Item	Model	Consumption current	Item	Model	Consumption current
CPU module	XGK-CPUA, H, U, SN, HN, UN	960	Analog input module	XGF-AV8A	420
				XGF-AC8A	420
DC24V input module	XGKCPUE,S	940	Analog output module	XGF-AD4S	200
				XGF-DV4A	190 (250)
				XGF-DC4A	190 (400)
				XGF-DC4S	200 (200)
				XGF-DV8A	190 (250)
				XGF-DC8A	190 (400)
				XGF-DV4S	200 (500)
AC110V input module	XGI-A12A	30	High speed counter module	XGF-HO2A	270
				XGF-HD2A	330
AC220V input module	XGI-A21A	20	Positioning module	XGF-PO3A	400
				XGF-PO2A	360
Relay output module	XGQ-RY1A XGQ-RY2A XGQ-RY2B	250 500 500		XGF-PO1A	336
				XGF-PD3A	860
				XGF-PD2A	790
Transistor output module	XGQ-TR2A XGQ-TR2B XGQ-TR4A XGQ-TR4B XGQ-TR8A XGQ-TR8B	70 70 130 130 230 230	Thermocouple input module	XGF-PD1A	510
			RTD input module	XGF-TC4S	610
			Motion control module	XGF-RD4A	490
			Insulation type conversion module	XGF-M16M	640
			Rnet I/F module	XGF-AD4S	200
			Pnet I/F module	XGL-RMEA	410
Triac output module	XGQ-SS2A	300	Dnet I/F module	XGL-PMEA	560
I/O mixed module	XGH-DT4A	110		XGL-DMEA	440
FENet I/F module (Optical/electrical)	XGL-EFMF XGL-EFMT	650 420	Cnet I/F module	XGL-C22A	330
				XGL-C42A	300
FDEnet I/F module (Master)	XGL-EDMF XGL-EDMT	650 420	-	-	-
			-	-	-

Value in ( ) means consumption current for external DC24V

## Chapter 8 Power Module

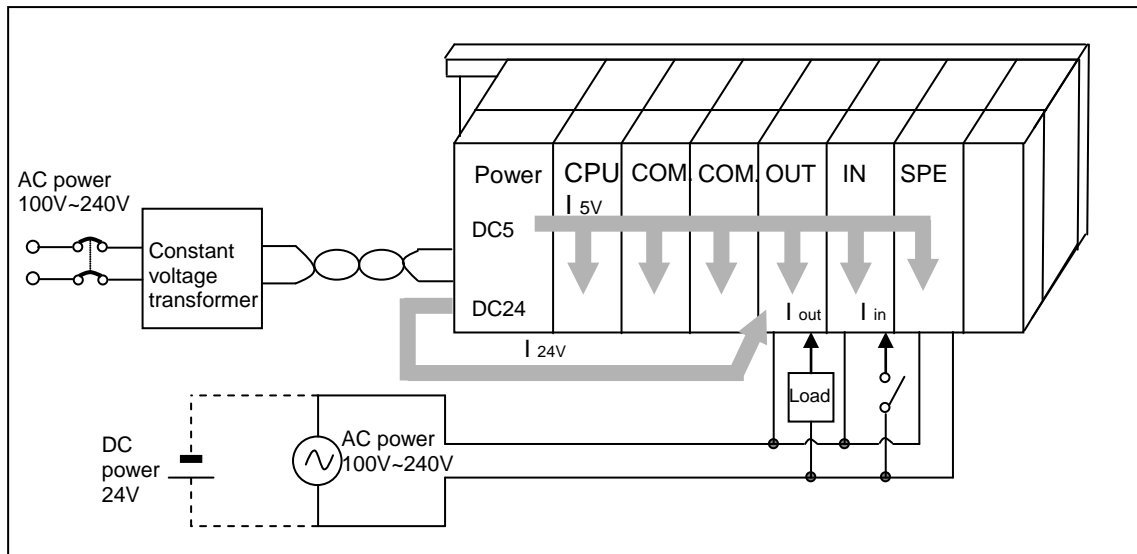

## 8.2 Specifications

Items		XGP-ACF1	XGP-ACF2	XGP-AC23	XGP-DC42
Input	Rated input voltage	AC110V/220V		AC220V	DC24V
	Input voltage range	AC85V ~ AC264V		AC170V ~ AC264V	-
	Input frequency	50 / 60 Hz (47 ~ 63 Hz)			-
	Inrush current	20A <sub>Peak</sub> or less			80A <sub>Peak</sub> or less
	Efficiency	65% or more			60% or more
	Input fuse	Built-in (user no change), UL standard (Slow Blow Type)			
	Allowable moment shutdown	within 10 ms			
Output 1	Output voltage	DC5V (±2%)			DC5V (±2%)
	Output current	3 A	6 A	8.5 A	6A
	Overcurrent protect	3.2A or more	6.6 A or more	9A or more	6.6 A or more
	Overvoltage protect	5.5V ~ 6.5V			
Output 2	Output voltage	DC24V (±10%)	-		-
	Output current	0.6 A			
	Overcurrent protect	0.7 A or more			
	Overvoltage protect	None			
Relay Output	Application	RUN contact (Refer to the section 8.3)			
	Rated switching voltage/current	DC24V, 0.5A			
	Minimum switching load	DC5V, 1 mA			
	Response time	Off→On/ On→Off: 10 ms or less/12 ms or less			
	Life	Mechanical: More than 20,000,000 times Electrical: More than 100,000 times at rated switching voltage/current			
RUN signal output	Relay output, Rating: DC24V, 0.5A				
Voltage indicator	Output voltage normal, LED On				
Cable specification	0.75 ~ 2 mm <sup>2</sup>				
Compressed terminal	RAV1.25-3.5,RAV2-3.5				
Weight	0.4 kg		0.6 kg	0.5 kg	

### Notes

1) Allowable Momentary Power Failure Time

The time that input voltage keeps normal output voltage (normal operation) in the state that AC110/220V voltage is below rated value (AC85 / 170V).

2) Over current protection

(1) If the current over the standard flows in DC5V, DC24V circuit, the over current protection device shutdowns the circuit to stop the system.

(2) In case of over current, remove the causes such as lack of current capacity or short circuits etc. and then restart the system.

3) Over voltage protection

If the voltage over the standard is applied in DC5V circuit, the over voltage protection device shutdowns the circuit to stop the system.

### 8.3 Part Names

Here describes the names of each part and its purpose of power module.

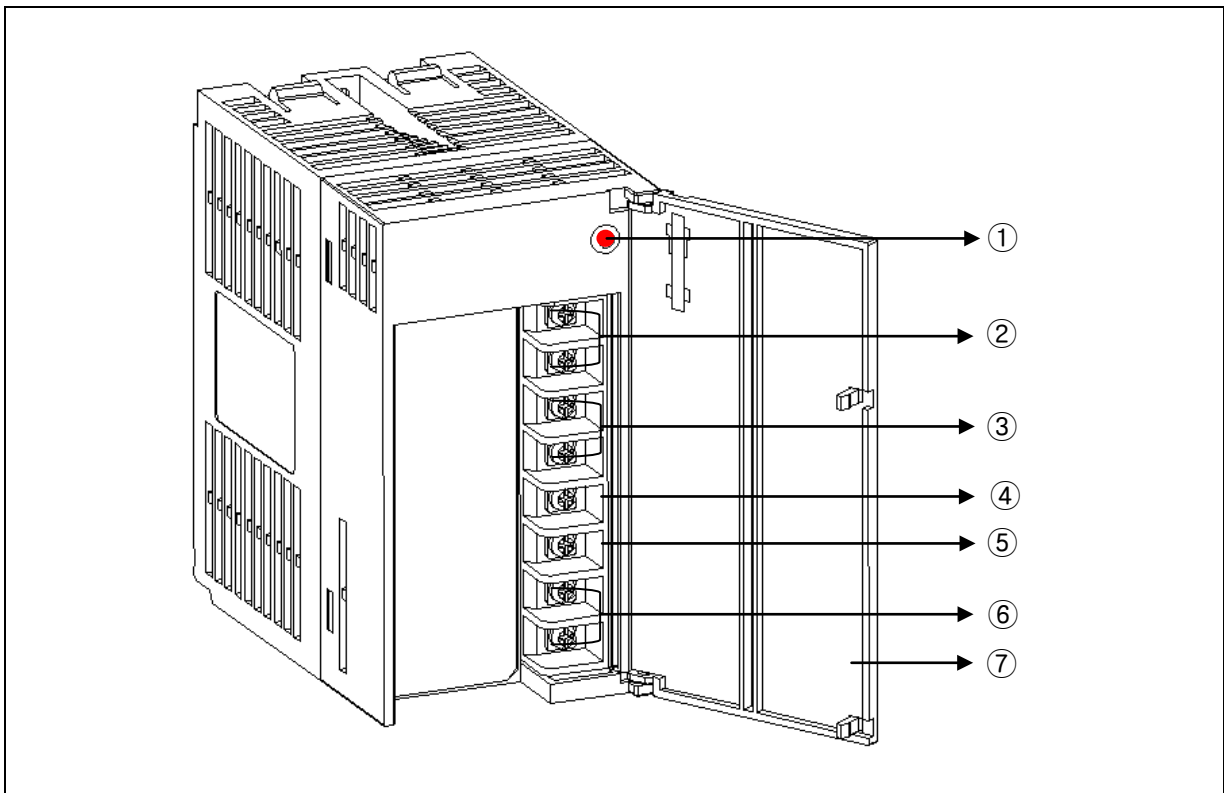

NO.	Names	Purpose
1	Power LED	DC5V power indication LED
2	DC24V, 24G terminal	Power supply to the module required for DC24V in output module. ▶ XGP-ACF2, XGP-ACF3 does not print out DC24V.
3	RUN terminal	Indicates RUN state of system. ▶ Off when CPU STOP error occurs. ▶ Off when CPU mode is changed to STOP mode.
4	PE terminal	Ground terminal for electric shock prevention
5	LG terminal	Ground terminal of power filter
6	Power input terminal	Power input terminal ▶ XGP-ACF1, XGP-ACF2, XGP-ACF3:AC100~240V connection ▶ XGP-DC42:DC24V connection
7	Terminal cover	Terminal block protection cover



## 8.4 Current Consumption/Power Calculation Example

Here describes which power module should be used in case of XGK system that the following module is mounted.

Type	Model	Number of setup	Voltage system	
			5V	24V
CPU module	XGK-CPUH	1	0.96A	-
12 Slot main base	XGB-B12M	-	-	-
Input module	XGI-D24A	4	0.2A	-
Output module	XGQ-RY2A	4	2.0A	-
FDEnet module	XGL-EDMF	2	1.3A	-
Profibus-DP	XGL-PMEA	2	1.12A	-
Current consumption	Calculation		0.96+0.2+2+1.3+1.12	-
	Result		5.58A	-
Energy consumption	Calculation		5.58×5V	-
	Result		27.9W	-

As the value of 5V current consumption is 5.58A, use XGP-ACF2(5V:6A) or XGP-AC23(5V:8.5A). If used XGP-ACF1(5V:3A), the system does not operate.

## Chapter 9 Base and Extended Cable

### 9.1 Specification

#### 9.1.1 Main Base

Main base installs Power Module, CPU Module, I/O Module and Special Communication Module.

Model	XGB-M12A	XGB-M08A	XGB-M06A	XGB-M04A
I/O module setup	12 module	8 module	6 module	4 module
Dimension (mm)	426 X 98 X 19	318 X 98 X 19	264 X 98 X 19	210 X 98 X 19
Hole distance for panel attachment	406 X 75	298 X 75	244 X 75	190 X 75
Hole spec. for panel attachment	φ 4.5 (M4 screw)			
Screw spec. for PE connection	(+)PHM 3 X 6 washer(φ 5)			
Weight (kg)	0.54	0.42	0.34	0.28

#### 9.1.2 Expansion Base

Expansion base installs Power Module, I/O Module and Special Communication Module.

Model	XGB-E12A	XGB-E08A	XGB-E06A	XGB-E04A
I/O module setup	12 module	8 module	6 module	4 module
Dimension (mm)	426 X 98 X 19	318 X 98 X 19	264 X 98 X 19	210 X 98 X 19
Hole distance for panel attachment	406 X 75	298 X 75	244 X 75	190 X 75
Hole spec. for panel attachment	φ 4.5 (M4 screw)			
Screw spec. for PE connection	(+)PHM 3 X 6 washer(φ 5)			
Weight (kg)	0.59	0.47	0.39	0.33

#### 9.1.3 Extended Cable

Model	XGC-E041	XGC-E061	XGC-E121	XGC-E301	XGC-E501	XGC-E102	XGC-E152
Length (m)	0.4	0.6	1.2	3	5	10	15
Weight (kg)	0.15	0.16	0.22	0.39	0.62	1.2	1.8

#### Notes

In case of combination of extended cable, do not exceed 15m.

9.2 Part Names

9.2.1 Main Base

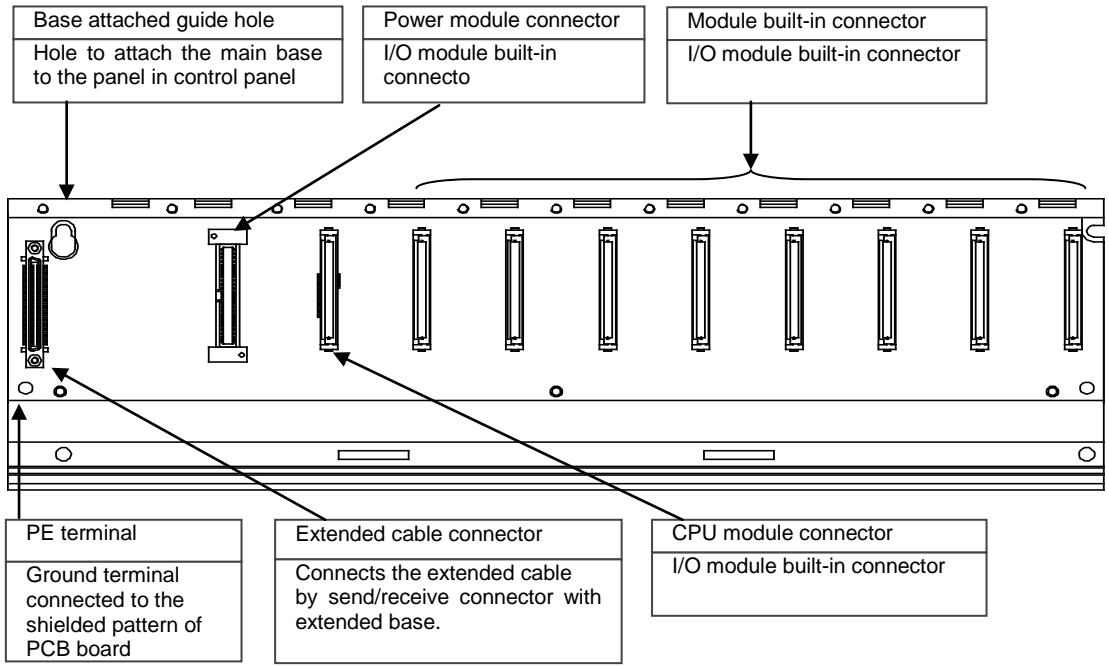

9.2.2 Expansion Base

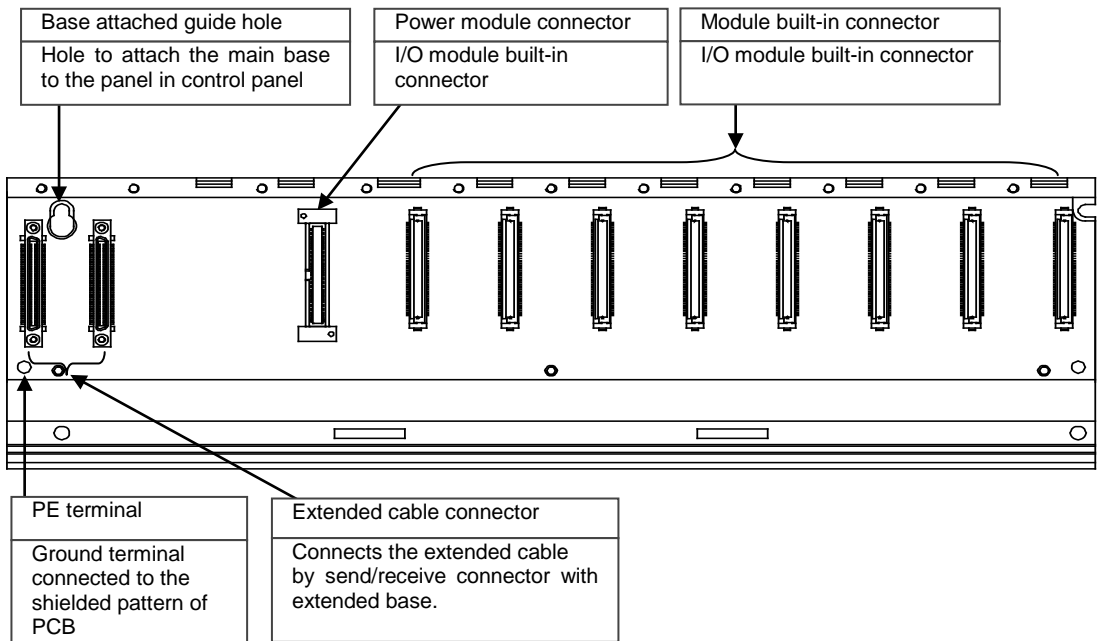

# Chapter 10 Built-in PID Functions

This chapter describes the XGK Series CPU built-in PID function. Sections 10.2 and 10.3 cover the principles and structure of PID control; the subsequent sections are dedicated to the PID function built into XGK Series.

## 10.1 Features

The features of the PID function built into XGK Series (XGK-CPUH, XGK-CPUA, XGK-CPUS, XGK-CPUE, XGK-CPUU) are as follows.

- (1) Enables high-precision control operation.
- (2) Supports a high-speed operation cycle of 0.6 ms.
- (3) Provides a symbol function for easy setting and monitoring.
- (4) Supports the forward and reverse processes.
- (5) Effectively prevents over/undershoot by means of powerful dual anti-windup.
- (6) Allows operation by external equipment(HMI).
- (7) Protects the system by limiting the maximum variation of PV.
- (8) Protects the driver by limiting the maximum variation, maximum value and minimum value of MV.
- (9) Enables PID control by the Auto-tuning function.
- (10) Enables the cascade PID control.

## 10.2 PID Control

PID control is a control method to keep the state of the control object at the Set Value. In case there exists an error between the preset Set Value and the value measured by the detector (current value), the controller operates to adjust the output (control signal) so that the current value can reach the Set Value.

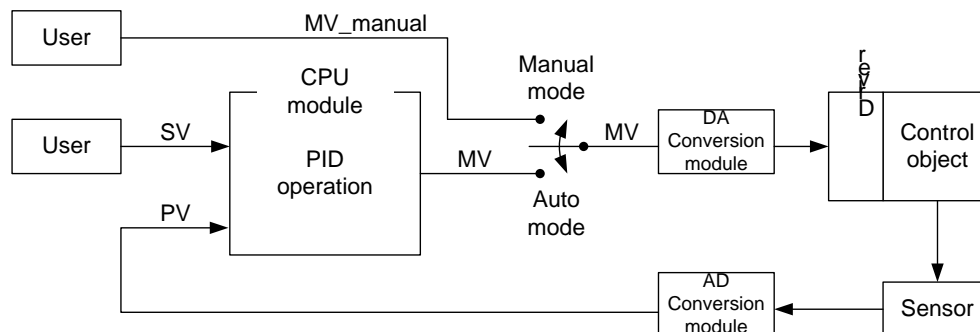

As illustrated in the figure above, the PLC functions as a controller for the whole control system. The sensor and driver are used respectively for the state detection and driving of the control object. The sensor detects the current states of the control object and transmits them to the controller, the PLC transfers the proper output to the driver, the driver drives the control object according to the controller output, then again the sensor detects the changed states and transmits them to the PLC (Closed Loop Control). The process of going around the control loop once is repeated at intervals ranging from a few seconds to hundreds of microseconds. The time taken is called the control cycle.

### 10.3 PID Control Operation

#### 10.3.1 Terms

Below are the terms used to describe the PID control operation.

SV	: The target state the control object should reach
T <sub>s</sub> (Ts)	: Sampling time (Control cycle)
K <sub>p</sub> (Kp)	: Proportional coefficient
T <sub>i</sub> (Ti)	: Integral time constant
T <sub>d</sub> (Td)	: Differential time constant
PV	: Current state of the control object, which is detected by the sensor
ERR	: Current error of the control object, which is represented by (SV – PV)
MV	: Control input or controller output
MV <sub>p</sub> (MVp)	: Proportional component of MV
MV <sub>i</sub> (MV <sub>i</sub> )	: Integral component of MV
MV <sub>d</sub> (MV <sub>d</sub> )	: Derivative component of MV

#### 10.3.2 PID expressions

PID expressions are as follows.

$$E = SV - PV \quad (10.3.1)$$

$$MV_p = K_p E \quad (10.3.2)$$

$$MV_i = \frac{K_p}{T_i} \int E dt \quad (10.3.3)$$

$$MV_d = K_p T_d \frac{dE}{dt} \quad (10.3.4)$$

$$MV = MV_p + MV_i + MV_d \quad (10.3.5)$$

An error is a mathematical expression that tells about how far the current system is from the state desired by the user.

Here is an example; a user wants the water in a electric pot to be kept at 50 °C and the current water temperature is 35 °C. Then, SV is 50 °C, PV is 35 °C. The error (E) is 15 °C, the difference between SV and PV. Upon detection of the error, the controller performs PID operation.

Note that, as shown in (10.3.5), MV is the sum of the P, I and D components (MV<sub>p</sub>, MV<sub>i</sub>, and MV<sub>d</sub>).

Therefore, if the D component is excluded from the PID control expression, then the PI control results and, if the I and D components are excluded, then P control results.

### 10.3.3 P control

As shown in the following expression (10.3.7), MV in P control is composed of the proportional term operation  $MV_p$  only. The proportional term operates in the form of the multiplication of the error by the proportional coefficient. The user must set the proportional coefficient properly according to the system. The greater the proportional coefficient is set, the more sensitive the system becomes to the error.

$$MV_p = K_p E \quad (10.3.6)$$

$$MV = MV_p \quad (10.3.7)$$

The development of P control of any virtual system has the following characteristics.

The virtual system below is designed for better understanding by the user, but may be different from an actual temperature system.

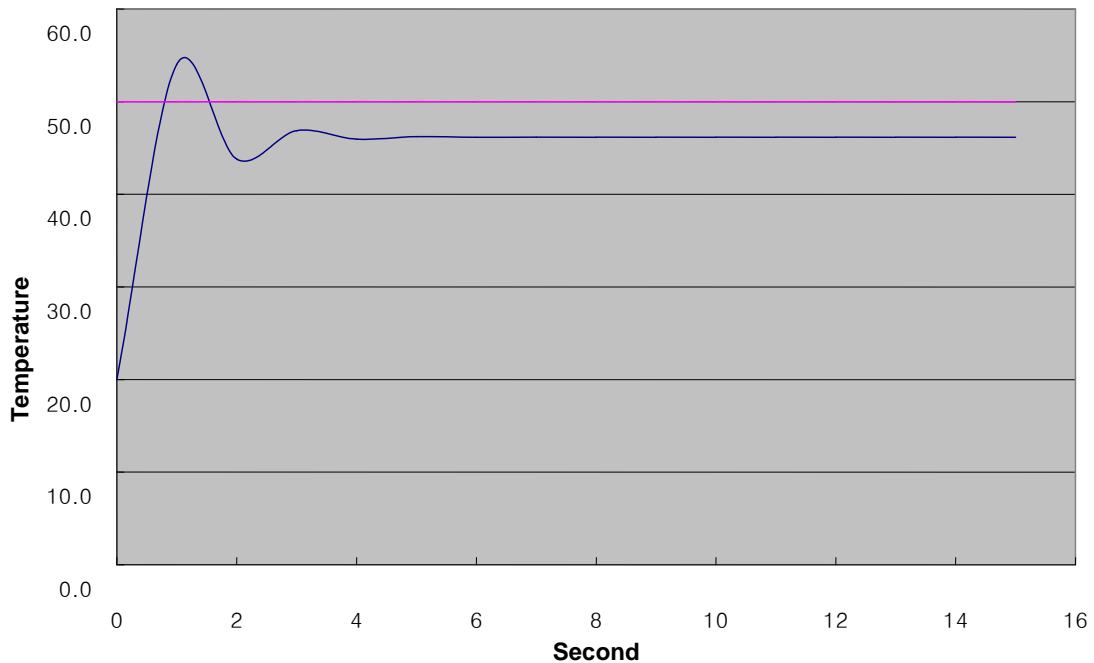

In the simulation above, SV is 50.0. the  $K_p$  value is properly adjusted to obtain the PV development above. Four seconds after the operation starts at the initial temperature of 20 °C, the system settles into the stable state and thereafter remains constant at 46.2 °C. The offset is 3.8 °C (around 7.6%). The reason there exists a permanent offset in P control is that, as PV approaches SV, the E gets smaller and also MV gets smaller and comes into equilibrium at the equilibrium point with  $K_p$  at the equilibrium point (46.2 °C). The offset inherent in the P controller can be compensated by using PI control.

10.3.4 PI control

As shown in the following expression (10.3.10), PI (Proportional-Integral) control is calculated as the sum of the proportional and integral terms. To reduce the offset, the shortcoming of the proportional term, PI control uses the integrated error.

$$MV_p = K_p E \tag{10.3.8}$$

$$MV_i = \frac{K_p}{T_i} \int E dt \tag{10.3.9}$$

$$MV = MV_p + MV_i \tag{10.3.10}$$

If the error, though constant, is integrated until it is reduced to zero, the integral amount is accumulated over time. Therefore the PI controller can be used to compensate for the offset characteristic of P control. It should be noted that the integral time constant (Ti) is the denominator of the integral term, therefore, the smaller the Ti value, the larger the integral effect. The following graph shows the result of PI control of the previously described P controlled system.

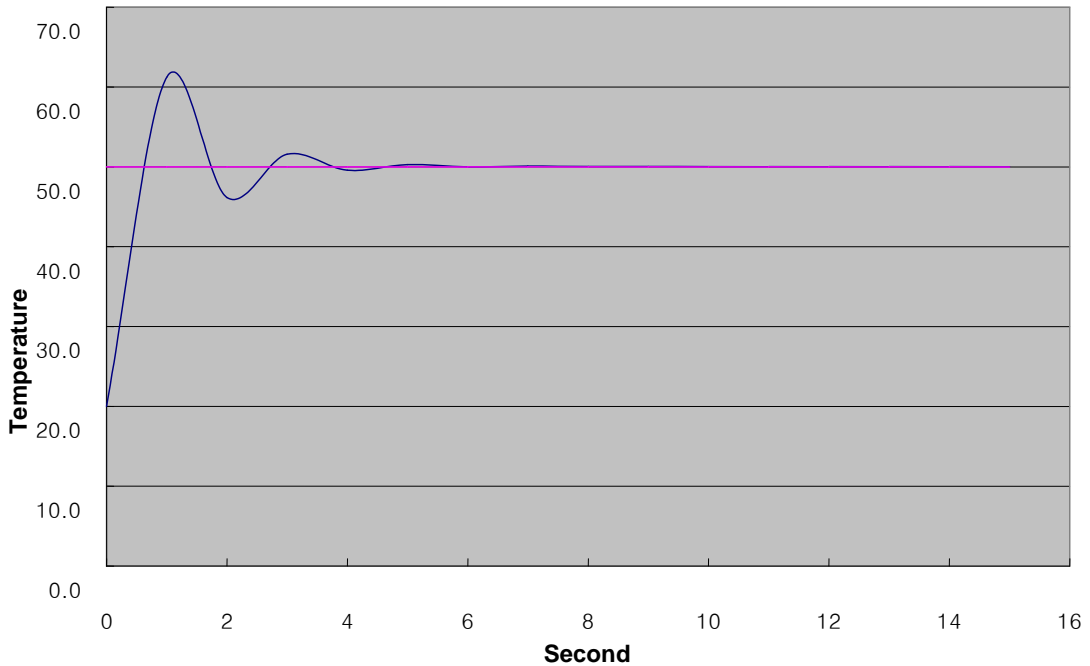

As a result of adding the integral effect, the offset disappears and the system converges exactly to 50 °C. At the initial control, however, there occurs an overshoot in which the temperature rises to 61.2 °C and then falls. An excessive overshoot imposes a burden on the system or, in some cases, unstabilizes the system, therefore, it should be reduced through proper coefficient tuning or can be improved through PID control using the integral effect.

### 10.3.5 PID control

As shown by (10.3.1) ~ (10.3.5), PID control reduces vibration during PI control by adding the derivative effect to PI control. The derivative effect operates only when the system state changes, regardless of the system error value. When the PV measurement signal at the system sensor is not clean or mixed with noise, however, an undesired derivative effect is created and causes an unstable operation of the heater or pump. To be sure that the derivative effect is not caused by such trivial changes as noise in the system, it is required to install a filter at the sensor input and set the derivative coefficient to a low value: in case of an actual system, it is common to set the derivative coefficient between 0.001 ~ 0.1.

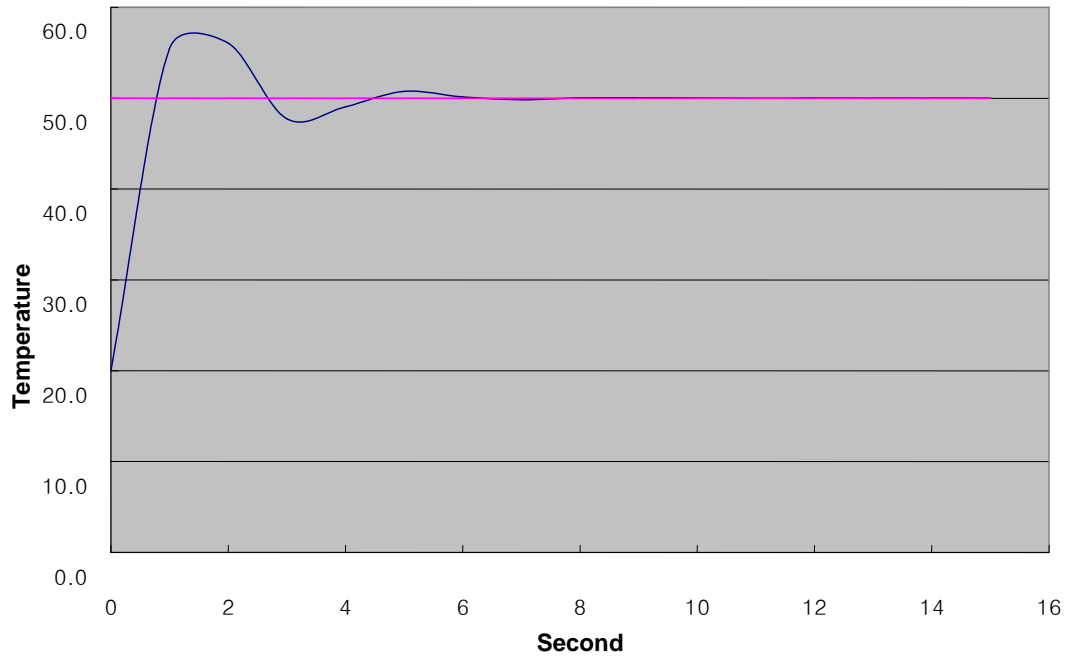



### 10.4 PID Instructions

#### 10.4.1 PID loop states

A PID loop has 5 states: PIDSTOP, AT (Auto-tuning), PIDRUN, PIDCAS, and PIDPAUSE.

(1) PIDSTOP is a state in which the output (MV) is represented by MV\_min, the internal states are initialized, and user settings are maintained. Under this condition, it is impossible to enter into PIDPAUSE.

(2) AT can be entered into by, in PIDSTOP only, setting the PIDxx\_AT\_EN bit to On and then executing the PIDRUN instruction. Once the AT operation is completed, the system automatically enters into PIDRUN. Tasks in AT include monitoring the system's response to a series of inputs and determining the PID coefficients (K\_p, T\_i, T\_d) and operation cycle (T\_s). Upon completion of AT, those values are updated and the previous coefficients are lost.

(3) PIDRUN is a state in which the PID loop executes a normal control operation. MV by PID operation is output and the changed settings are all applied since each scan operation is executed independently. If the contact in front of the PIDRUN instruction is set to On or if the PIDRUN instruction exists on the ladder program and PIDxx\_REM\_RUN is set to On, then it is possible to enter into PIDRUN.

(4) PIDCAS is a state in which two loops (master and slave loops) execute a control operation. Setting the two loops in the same way as with PIDRUN and then using the PIDCAS instruction enables to enter into PIDCAS, and the internal connection necessary for the interworking between the two loops is automatically generated allowing data exchange between the loops. Loops operated in cascade are displayed in the state flag PIDxx\_STATE, under which state the remote operation PIDxx\_REM\_RUN bit does not operate.

(5) PIDPAUSE is a state in which output, internal states and user settings are all maintained and the control operation is paused. Setting PIDxx\_PAUSE bit to On or using the PIDPAUSE instruction enables to enter into PIDPAUSE. But, this is only possible when the previous state is PIDRUN.

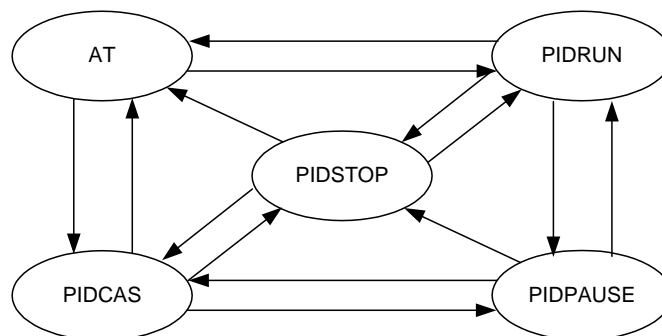

### 10.4.2 PID instruction group

The PID instruction group includes 5 instructions: PIDRUN, PIDCAS, PIDINIT, PIDPRMT, and PIDPAUSE. In fact, all operations of the PID function are performed by the PIDRUN or PIDCAS instruction. The three other additional instructions (PIDINIT, PIDPRMT, PIDPAUSE) operate normally when the PIDRUN or PIDCAS instruction also exists on the ladder program. They are for the convenience in using the PIDRUN or PIDCAS instruction.

#### (1) PIDRUN

PIDRUN is the most basic PID control instruction that is responsible for single PID loop control.

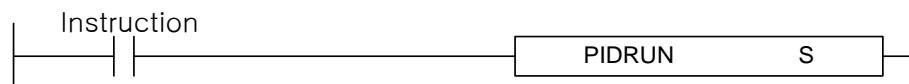

Operand S has the range 0 ~ 31 (constants) and means the loop number.

#### (2) PIDCAS

PIDCAS is a instruction to implement a cascade control using two loops.

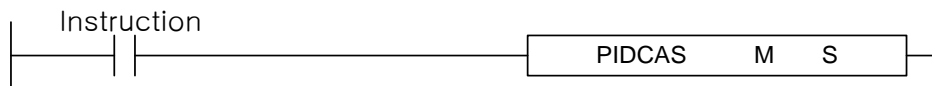

Operand M is the master loop with the range 0 ~ 31 (constants) and means the loop number.  
Operand S is the slave loop with the range 0 ~ 31 (constants) and means the loop number.

#### Note

Operands M and S in PIDCAS cannot be the same.  
Operand M means the number of the master loop during cascade PID operation, while operand S means the number of the slave loop.  
Basically, the master loop inputs its MV into SV of the slave loop during operation, while the slave loop executes its operation using the SV value input through the master loop.  
In addition, the two loops observe each other's operation information (wind-up, manual mode, auto mode shift, etc).

## Chapter 10 Built-in PID Functions

### (3) PIDINIT

PIDINIT is used to initialize the settings and states of the current PID loop. All the setting values of the corresponding loop are initialized as 0 (Off in case of bit).

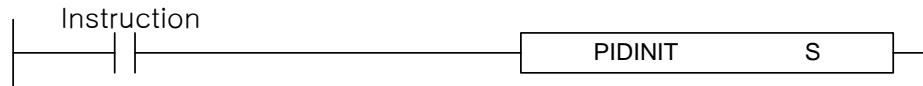

Operand S has the range 0 ~ 31 (constants) and means the loop number.

### (4) PIDPRMT

PIDPRMT facilitates parameter changes in the loop memory configuration.

As soon as the contact is On, the main setting values of the PIDRUN instruction (SV, T<sub>s</sub>, K<sub>p</sub>, T<sub>i</sub>, T<sub>d</sub>) are simultaneously changed to the values set by the user. Make sure that each of the 5 setting values holds its respective data type as shown the table below.

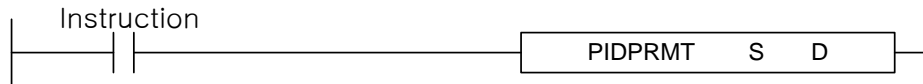

Device	Parameter	Data Type	Setting Ex.	Actual Unit
S+0	SV	[WORD]	5000	
S+1	T <sub>s</sub>	[WORD]	1000	0.1 msec
S+2	K <sub>p</sub>	[REAL]	3.32	sec
S+4	T <sub>i</sub>	[REAL]	9.3	sec
S+6	T <sub>d</sub>	[REAL]	0.001	sec

Operand S represents the first word address of the place the parameter to be changed is stored.

Operand D has the range 0 ~ 31 (constants) and means the loop number.

### (5) PIDPAUSE

PIDPAUSE is used to switch the corresponding loop from the PIDRUN state to the PIDPAUSE state.

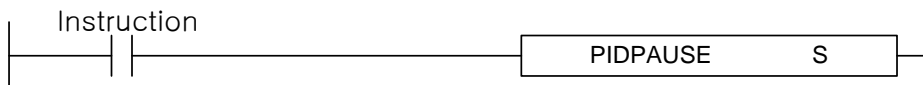

Operand S has the range 0 ~ 31 (constants) and means the loop number.

## 10.5 PID Flag Configuration

The table below shows the PID flag configuration for use of the built-in PID function.

KDevice Zone	Symbol	Data Type	Content
K10000+m	_PIDn_MAN	Bit	PID Output Select (0:Auto, 1:Manual)
K10020+m	_PIDn_PAUSE	Bit	PID Pause (0: STOP/RUN 1:PAUSE)
K10040+m	_PIDn_REV	Bit	PID Operation Select (0:Fwd, 1:Rev)
K10060+m	_PIDn_AW2D	Bit	PID Anti Wind-up2 Prohibited (0:Operated, 1:Prohibited)
K10080+m	_PIDn_REM_RUN	Bit	PID Remote (HMI) Run bit (0:STOP, 1:RUN)
K10100+m	_PIDn_P_on_PV	Bit	PID Proportional Calculation Source Select (0:ERR, 1:PV)
K10120+m	_PIDn_D_on_ERR	Bit	PID Derivative Calculation Source Select (0:PV, 1:ERR)
K10140+m	_PIDn_AT_EN	Bit	PID Auto-tuning Setting (0:Disable, 1:Enable)
K10160+m	_PIDn_MV_BMPL	Bit	MV Non-impact Conversion for PID Mode Conversion (A/M) (0:Disable, 1:Enable)
K1024+32n	_PIDn_SV	INT	PID Set Value (SV) - Loop n
K1025+32n	_PIDn_T_s	WORD	PID Operation Cycle (T_s)[0.1msec] - Loop n
K1026+32n	_PIDn_K_p	REAL	PID P - Constant (K_p) - Loop n
K1028+32n	_PIDn_T_i	REAL	PID I - Constant (T_i)[sec] - Loop n
K1030+32n	_PIDn_T_d	REAL	PID D - Constant (T_d)[sec] - Loop n
K1032+32n	_PIDn_d_PV_max	WORD	PID PV Variation Limit - Loop n
K1033+32n	_PIDn_d_MV_max	WORD	PID MV Variation Limit - Loop n
K1034+32n	_PIDn_MV_max	INT	PID MV Maximum Value Limit - Loop n
K1035+32n	_PIDn_MV_min	INT	PID MV Minimum Value Limit - Loop n
K1036+32n	_PIDn_MV_man	INT	PID Manual Output (MV_man) - Loop n
K1037+32n	_PIDn_STATE	WORD	PID State - Loop n
K10370+320n	_PIDn_ALARM0	Bit	PID Alarm 0 (1:T_s The setting is low) - Loop n
K10371+320n	_PIDn_ALARM1	Bit	PID Alarm 1 (1:K_p is 0) - Loop n
K10372+320n	_PIDn_ALARM2	Bit	PID Alarm 2 (1:PV Variation Limited) - Loop n
K10373+320n	_PIDn_ALARM3	Bit	PID Alarm 3 (1:MV Variation Limited) - Loop n
K10374+320n	_PIDn_ALARM4	Bit	PID Alarm 4 (1:MV Maximum Value Limited) - Loop n
K10375+320n	_PIDn_ALARM5	Bit	PID Alarm 5 (1:MV Minimum Value Limited) - Loop n
K10376+320n	_PIDn_ALARM6	Bit	PID Alarm 6 (1:AT Abnormal Cancel) - Loop n
K10377+320n	_PIDn_ALARM7	Bit	PID Alarm 7 - Loop n
K10378+320n	_PIDn_STATE0	Bit	PID State 0 (0:PID_STOP, 1:PID_RUN) - Loop n
K10379+320n	_PIDn_STATE1	Bit	PID State 1 (0:AT_STOP, 1:AT_RUN) - Loop n
K1037A+320n	_PIDn_STATE2	Bit	PID State 2 (0:AT_UNDONE, 1:DONE) - Loop n
K1037B+320n	_PIDn_STATE3	Bit	PID State 3 (0:REM_STOP, 1:REM_RUN) - Loop n
K1037C+320n	_PIDn_STATE4	Bit	PID State 4 (0:AUTO_OUT, 1:MAN_OUT) - Loop n
K1037D+320n	_PIDn_STATE5	Bit	PID State 5 (0:CAS_STOP, CAS_RUN) - Loop n
K1037E+320n	_PIDn_STATE6	Bit	PID State 6 (0:SLV/SINGLE, 1:CAS_MST) - Loop n
K1037F+320n	_PIDn_STATE7	Bit	PID State 7 (0:AW_STOP, 1:AW_ACT) - Loop n
K1038+32n	_PIDn_PV	INT	PID Current Value (PV) - Loop n
K1039+32n	_PIDn_PV_old	INT	PID Previous Current Value (PV_old) - Loop n
K1040+32n	_PIDn_MV	INT	PID Output Value (MV) - Loop n
K1041+32n	_PIDn_MV_BMPL_val	WORD	PID Non-impact Operation Memory - Loop n
K1042+32n	_PIDn_ERR	DINT	PID Control Error Value - Loop n
K1044+32n	_PIDn_MV_p	REAL	PID Output Value P Component - Loop n
K1046+32n	_PIDn_MV_i	REAL	PID Output Value I Component - Loop n
K1048+32n	_PIDn_MV_d	REAL	PID Output Value D Component - Loop n
K1050+32n	_PIDn_DB_W	WORD	PID Dead Band Setting (Operation after Stabilization) - Loop n
K1051+32n	_PIDn_Td_lag	WORD	PID Differentiation Function Lag Filter - Loop n
K1052+32n	_PIDn_AT_HYS_val	WORD	PID Auto-tuning Hysteresis Setting - Loop n
K1053+32n	_PIDn_AT_SV	INT	PID SV Setting for Auto-tuning - Loop n
K1054+32n	_PIDn_AT_step	WORD	PID Auto-tuning Display (User Setting Prohibited) - Loop n
K1055+32n	_PIDn_INT_MEM	WORD	PID Internal Memory (User Setting Prohibited) - Loop n

\*  : User setting prohibited

\* n : PID loop number in decimal form

\* m : PID loop number in hexadecimal form

## Chapter 10 Built-in PID Functions

The PID instruction uses part of the K device to perform operation. When the PID function is not used, the K device can be used as a general Keep Relay.

The area of K0000 ~ K0999 is not used by the PID function so as to guarantee compatability with previous PLC models and secure the user's area.

K10000 ~ K1023F is the common bit area for all PID loops. The bit states and settings of the loops are collectively arranged in the front part of the PID area. Thirty two - the maximum number of loops that can be used by the PID function - bits comprise a double word and the states and settings of each loop are stored in each bit order. But the loop number is represented in hexadecimal form.

K1024 ~ K1055 is the individual data area for PID Loop 0, where the settings and states of Loop 0 are stored. In this area are stored the settings for PID Loop 0 (SV, dPV\_max, MV\_man, T\_s, Kp, Ti, Td, MV\_max, MV\_min, dMV\_max) and, while the PID function is performed, the states for PID Loop 0 (PV, ETC, MV, MV\_rvs, ERR, MVp, Mvi, MVd, PV). By writing data into the set memory area, the user can change the PID setting at any time even during operation and obtain the corresponding results in the next cycle.

K1056 ~ K2047 is the memory part of Loops 1 ~ 31 that are in the same form as Loop 0. Each loop operates independently. If the user wants a dependent operation such as application of cascade, then he must do some work to connect the states and settings of the loop.

In addition, please refer to the K device memory configuration in the latter part of this manual for an understanding of the accurate memory location of PID.

For performance improvement of the product, the location and order of the memory area is subject to change without prior notice.

### Note

1) PID Memory Description Format

\_PIDn\_MAN                                    n : Loop number

Ex) \_PID10\_MAN : Means MAN of Loop 10.

2) Common Bit Area

Ex) K10040+ (25) = K10040+ (19h) = K10059 : PID25\_REV bit of Loop 25

3) Individual Data Area

Ex) K1024+ (32\*1) = K1056 : SV of Loop 1

### 10.5.1 Common bit area

The common bit area is the part that contain all bit data for the 32 loops. All information 32 loops have for a signal item is combined to take the form of 32 bit double word; the nth bit provides information on the nth loop; m is the hexadecimal value of loop number n.

#### (1) **\_PIDn\_MAN (PID MANual operation enable)**

- Setting Area

K Device Area : K10000+m

Unit : Bit

This allows you to determine whether the PID function of the nth loop will operate in AUTO or in Manual.

In AUTO, the result of performing a normal PID operation is output; In MANUAL, a random Set Value desired by the user (**\_PIDn\_MV\_man**) is output without performing the PID operation.

If the corresponding bit is Off, then it is set to [Default] AUTO.

#### (2) **\_PIDn\_PAUSE (PID PAUSE mode)**

- Setting Area

K DEVICE AREA : K10020+m

Unit : Bit

This allows the nth PID Loop to enter into PAUSE

Even when switching from PAUSE to RUN again, the control continues to operate. If the system state is changed in PAUSE, the control system may produce an unexpected result. So, be very careful when using the the PAUSE function.

If the corresponding bit is Off, [Default] PAUSE is cleared.

#### (3) **\_PIDn\_REV (PID REVerse operation)**

- Setting Area

K DEVICE AREA : K10040+m

Unit : Bit

This allows you to set the control system as Forward system or Reverse system.

If the system state rises as the system input value rises, it is defined as Forward system; If the system states falls as the system input value rises, it is Reverse system.

A boiler is a Forward system because the temperature rises as the system input rises; a cooler is a Reverse system because the temperature falls as the system input rises.

If the corresponding bit is Off, it is set to [Default] Forward system.

#### Note

##### **\_PIDn\_PAUSE**

- (1) Putting the PID loop into PAUSE by using **PIDn\_PAUSE** and **PIDPAUSE** brings all operations to a stop and outputs the last calculation values before PAUSE. If the system state is changed but proper control is not exercised, the control system may produce an unexpected result. So, be very careful when using the the PAUSE function.
- (2) In the first PLC scan, **PIDRUN** performs initialization to turn the PAUSE bit to Off. If PLC is turned on in PAUSE, it quits the PAUSE mode and enters into the STOP or Run mode.

### (4) **\_PIDn\_AW2D (PID Anti Wind-up 2 Disable)**

- Setting Area

K DEVICE AREA : K10060+m

Unit : Bit

If this bit is turned OFF at the user's will, The Anti Wind-up2 function is inactivated.

The Anti Wind-up function is described in detail in 10.6.

If the corresponding bit is Off, [Default] Anti Wind-up2 is enabled.

### (5) **\_PIDn\_REM\_RUN (PID REMote RUN)**

- Setting Area

K DEVICE AREA : K10080+m

Unit : Bit

This is the external operation instruction of PIDRUN and has the same effect as when the contact of PIDRUN is turned On/Off. In fact, PIDRUN performs an OR operation of the "PIDRUN input condition" contact and the corresponding bit in order to decide whether to perform the operation. Using this function enables you to assign the operation contact of PIDRUN to a fixed address, facilitating easier use of external input/output devices such as HMI.

If the corresponding bit is Off, [Default](the contact is Off) PIDRUN comes to STOP.

### (6) **\_PIDn\_P\_ov\_PV (PID P on PV)**

- Setting Area

K DEVICE AREA: K10100+m

Unit : Bit

This sets the P operation source of the corresponding PID loop to PV. P operation is performed on ERR or PV. P operation moves relatively slowly to a stable state when using PV than when using ERR under the unstable instantaneous control due to initial response or disturbance. This implies that the change in output is slow and a heavy load is not imposed on the driver. But, with the change in the range of the internal operation value, the Anti Wind-up function does not operate.

If the corresponding bit is Off, PID performs P operation on the ERR value and, if it is On, P operation is performed on the PV value.

### (7) **\_PIDn\_D\_on\_ERR (PID D on ERRor)**

- Setting Area

K DEVICE AREA : K10120+m

Unit : Bit

This sets the D operation source of the corresponding PID loop to ERR. D operation is performed on ERR or PV. In case of D operation using ERR, D response shows a dramatic change at the moment SV is changed by the user and an excessive input may be applied to the driver. To prevent this, the method of using PV for D operation is used and the [Default] value is also set to support D operation using PV. Using ERR without this algorithm turns the corresponding bit On.

If the corresponding bit is Off, PID performs D operation on the PV value and, if it is On, D operation is performed on the ERR value.

#### Note

#### **\_PIDn\_REM\_RUN**

This bit is stored in the K device even though the PLC stops. If the PLC is stopped and restarted with this bit On (eg. power outage), the system is initialized at the first scan and then PIDRUN operates.

### (8) \_PIDn\_AT\_EN (PID Auto-Tuning ENable)

- Setting Area

K DEVICE AREA : K10140+m

Unit : Bit

This performs AT (Auto-tuning) of the corresponding PID loop. The approximate  $T_s$  (operation cycle) and PID coefficients ( $K_p$ ,  $T_i$ ,  $T_d$ ) of the system are determined through AT. Do not forget to set the PIDn\_HYS\_val item before starting AT. The AT function is described in detail in 10.6.

If the corresponding bit is Off, the [Default] AT function is Disabled and AT is performed in the rising edge.

### (9) \_PIDn\_MV\_BMPL (PID MV BuMPLess changeover)

- Setting Area

K DEVICE AREA : K10160+m

Unit : Bit

This allows to not only determine an appropriate MV value through operation so that MV can continue smoothly when the corresponding PID loop changes from manual to auto output mode, but also reflect the MV value to the internal state so as to stabilize MV. This function shows an algorithm difference between single operation and cascade operation, but both operations are performed by this bit.

If the corresponding bit (in cascade operation, the corresponding bit of the master loop) is On, Bumpless changeover is performed. If it is Off, The [Default] Bumpless changeover function is Disabled.

#### Note

#### \_PIDn\_AT\_EN

This bit is initialized as Off when the PLC changes to Run mode. If the PLC is stopped and restarted with this bit On (eg. power outage), the system is initialized at the first scan but does not enter into AT mode again. Since there is no change in the PID settings, the system operates in the state before the PLC stops.

#### \_PIDn\_MV\_BMPL

Assuming that the manual output value is 1000 and the auto output of 2000 is required, the driver receives the value of 1000 for system operation and instantly receives 2000 at the time of mode conversion. If the corresponding bit is On, the corresponding PID loop outputs 1000 at the time of mode conversion and performs an operation in order that the output gradually increases to 2000.



### 10.5.2 Individual data area

The individual data area is in the range of K1024 ~ K2047 and a 32 word length is assigned for each of 32 loops. So, the individual data area of the nth loop is K (1024+32n) ~ K (1055+32n).

#### (1) **\_PIDn\_SV (PID Set-point Value)**

- Setting Area

K DEVICE AREA : K1024+32n

Unit : INT [ -32768 ~ 32767 ]

This is the SV setting part of the corresponding loop.

As described in the previous section, this is used to set the system state as desired by the user. The system state is displayed in numeral and must be input after converted to PV according to the system gain.

In case of a system in which PV is sensed as 5000 at the temperature of 50 °C, if the temperature controlled at 50 °C, SV is set to 5000.

#### (2) **\_PIDn\_T\_s (PID Sampling Time)**

- Setting Area

K DEVICE AREA : K1025+32n

Unit : WORD [ 0 ~ 65535 ]

This sets the sampling time of the corresponding loop.

The sampling time is a time cycle in which a control operation is performed. This can be set in the range of 0.1msec to 6553.5 msec in the unit of 0.1msec; an integer value of 1 is assigned for each 0.1ms. If 100ms of sampling time is required, 1000 is input to **\_PIDn\_T\_s**.

If the user sets the sampling time to 0, the scan cycle control mode is also set. In this case, as a control operation occurs in each scan, a full speed control operation is performed in the current environment.

When the current scan speed is exceeded due to the too short sampling time, The ALARM bit of **\_PIDn\_STATE** is displayed.

#### (3) **\_PIDn\_K\_p (PID Proportional Gain)**

- Setting Area

K DEVICE AREA : K1026+32n

Unit : REAL [ -3.40282347e+38 ~ -1.17549435e-38 , 0 , 1.17549435e-38 ~ 3.40282347e+38 ]

This sets the proportional constant for the corresponding loop. As **K\_p** is multiplied into the P, I, D (Proportional, Integral, Derivative) terms, the larger **K\_p** is, the larger the proportional and derivative effects are and the smaller the integral effect is.

If **\_PIDn\_K\_p** is set to 0, P control is not performed. For more details, refer to 10.6.

**K\_p** can be set in the short/long real number (REAL) range.

#### Note

##### **\_PIDn\_SV**

PID changes the output (MV) through several times of operations until SV equals PV. So, when SV is 0, PIDRUN may be seen as inoperable.

If SV of a simple heater with the current temperature of 20°C and PV of 2000 (20 °C) PID will output 0 as MV and will not output until PV goes below 0 (0 °C).

### (4) **\_PIDn\_T\_i (PID integral Time gain)**

- Setting Area

K DEVICE AREA : K1028+32n

Unit : REAL [ -3.40282347e+38 ~ -1.17549435e-38 , 0 , 1.17549435e-38 ~ 3.40282347e+38 ]

This sets the integral time constant ( $T_i$ ) of the corresponding loop. As  $T_i$  divides the I (integral) term, the larger  $T_i$ , the smaller the integral effect.

If  $\_PIDn\_T\_i$  is set to 0, I control is not performed. For more details, refer to 10.6.

$T_i$  can be set in the short/long real number (REAL) range.

### (5) **\_PIDn\_T\_d (PID derivative Time gain)**

- Setting Area

K DEVICE AREA : K1030+32n

Unit : REAL [ -3.40282347e+38 ~ -1.17549435e-38 , 0 , 1.17549435e-38 ~ 3.40282347e+38 ]

This sets the derivative time constant ( $T_d$ ) of the corresponding loop. As  $T_d$  is multiplied into the D (derivative) term, the larger  $T_d$ , the larger the derivative effect.

If  $\_PIDn\_T\_d$  is set to 0, D control is not performed. For more details, refer to 10.6.

$T_d$  can be set in the short/long real number (REAL) range.

### (6) **\_PIDn\_dPV\_max(PID delta PV MAXimum limit)**

- Setting Area

K DEVICE AREA : K1032+32n

Unit : WORD [ 0 ~ 65535 ]

This limits the PV variation of the corresponding loop.

In actual control, PV does not always reflect the exact system state. Unwanted signals caused by sensor malfunction, noise or disturbance can be mixed and reflected in PV. Like this, PV often undergoes a sudden change and causes a large change in PID output. It is a priority to prevent a PV change greater than the value set in  $\_PIDn\_dPV\_max$ . Meanwhile, if  $\_PIDn\_dPV\_max$  is set too small, the system change is slowly reflected and the convergence time takes longer. Therefore, setting should be made according to the system features.

If this is set to 0, the function does not operate.

### (7) **\_PIDn\_dMV\_max (PID delta MV MAXimum limit)**

- Setting Area

K DEVICE AREA : K1033+32n

Unit : WORD [ 0 ~ 65535 ]

This limits the MV variation of the corresponding loop. A sudden change in the output of the control system may cause a system instability or impose a heavy load on the driver resulting in failure or unstable operation. To prevent this, this item limits the controller output variation. If this is set to 0, the function does not operate.

### (8) **\_PIDn\_MV\_max (PID MV MAXimum limit)**

- Setting Area

K DEVICE AREA : K1034+32n

Unit : INT [ -32768 ~ 32767 ]

This limits the maximum MV value of the corresponding loop.

This prevents overload and system errors by limiting the maximum value of the controller output transferred to the output equipment. This also prevents the transfer of an unwanted value by overflow. If **\_PIDn\_MV\_max** and **\_PIDn\_MV\_min** are both set to 0, this function does not operate.

### (9) **\_PIDn\_MV\_min (PID MV MINimum limit)**

- Setting Area

K DEVICE AREA : K1035+32n

Unit : INT [ -32768 ~ 32767 ]

This limits the minimum MV value of the corresponding loop.

This prevents system errors by limiting the minimum value of the controller output transferred to the output equipment. This also prevents the transfer of an unwanted value by overflow.

### (10) **\_PIDn\_MV\_man (PID MANual MV variable)**

- Setting Area

K DEVICE AREA : K1036+32n

Unit : INT [ -32768 ~ 32767 ]

When the corresponding loop is set to manual operation, this designates MV.

If **\_PIDn\_MAN** in the common bit area is ON, the **\_PIDn\_MV\_man** value is output as the MV value of the corresponding loop.

### (11) **\_PIDn\_STATE (PID STATE)**

- Setting Prohibited

K DEVICE AREA : K1037+32n or K10370+320n ~ K1037F+320n

Unit : WORD [ h00 ~ hff ] or BIT

This displays the state or abnormalities of the corresponding loop.

This is located at the address K1037+32n and each of the 16 bits has its own meaning. Only some of the 16 bits are currently in use.

STATE turns On when the corresponding operation occurs and returns Off when it is cleared.

The upper 8 bits of STATE (**\_PIDn\_ALARM 0~\_PIDn\_ALARM 7**) display abnormalities of the loop.

The lower 8 bits of STATE (**\_PIDn\_STATE 0~\_PIDn\_STATE 7**) displays the control state of the loop.

Each bit is assigned as follows.

**\_PIDn\_ALARM 0** (K10370+32n): Indicates the operation is skipped because **T\_s** is set too small set.

**\_PIDn\_ALARM 1** (K10371+32n): Indicates the **K\_p** value is 0.

**\_PIDn\_ALARM 2** (K10372+32n): Indicates the PV variation is limited.

**\_PIDn\_ALARM 3** (K10373+32n): Indicates the MV variation is limited.

**\_PIDn\_ALARM 4** (K10374+32n): Indicates the maximum MV value is limited.

**\_PIDn\_ALARM 5** (K10375+32n): Indicates the minimum MV value is limited.

**\_PIDn\_ALARM 6** (K10376+32n): Indicates AT has been canceled abnormally.

**\_PIDn\_STATE 0** (K10378+32n): Indicates PID operation is performed. (valid in case of PLC Run)

**\_PIDn\_STATE 1** (K10379+32n): Indicates PID AT is being performed.

**\_PIDn\_STATE 2** (K1037A+32n): Indicates PID AT has been completed.

**\_PIDn\_STATE 3** (K1037B+32n): Indicates PID is in remote operation by **\_PIDn\_REM\_RUM** bit.

**\_PIDn\_STATE 4** (K1037C+32n): Indicates PID is in manual output mode.

**\_PIDn\_STATE 5** (K1037D+32n): Indicates the PID loop belongs to cascade.

**\_PIDn\_STATE 6** (K1037E+32n): Indicates the PID loop is the cascade master loop.

**\_PIDn\_STATE 7** (K1037F+32n): Indicates Anti Wind-up is in operation during PID operation.

### (12) \_PIDn\_PV (PID Process Variable)

- Input/Output Area

K DEVICE AREA : K1038+32n

Unit : INT [ -32768 ~ 32767 ]

This displays the PV of the corresponding loop.

PV is an indicator of the current state of the system. In general, the input from the sensor is stored on the U device of the CPU via an input device such as A/D conversion module: At each scan, this value should be transferred to \_PIDn\_PV using a instruction such as MOV. Please refer to the program examples in the latter part of this manual.

### (13) \_PIDn\_PV\_old (PID previous PV)

- Setting Prohibited

K DEVICE AREA : K1039+32n

Unit : INT [ -32768 ~ 32767 ]

This is used internally for derivative and integral operations at a step prior to the PV state of the corresponding loop. This can be referred to when necessary. Input of a random value will lead to a malfunction.

### (14) \_PIDn\_MV (PID Manipulated output Variable)

- Input/Output Area

K DEVICE AREA : K1040+32n

Unit : INT [ -32768 ~ 32767 ]

This displays the MV of the corresponding loop.

MV is a signal source for system startup. Contrary to the description of \_PID\_PV in (12), this values is transferred at each scan to the U device using a instruction such as MOV and then used as a system startup input via an output device such as D/A conversion module. Please refer to the program examples in the latter part of this manual.

### (15) \_PIDn\_MV\_BMPL\_val (PID MV BuMPLess changeover VALue)

- Setting Prohibited

K DEVICE AREA : K1041+32n

Unit : WORD [ 0 ~ 65535 ]

This stores the information necessary for the Bumpless changeover operation of the corresponding loop. The corresponding memory is automatically set and input by PID-internal operation and this value should not be set by the user.

#### Note

#### Bumpless Change Over

When the PID controller is converted to manual output mode and back again to auto output mode, the output is increased again from 0 as in a freshly started control system. This causes a mode conversion impact to the system. To avoid this, the MV\_BMPL function is used; when the current system is converted to auto mode with the corresponding bit authorized, this senses the system's last state in manual mode and lets the control output continue smoothly from that point. Furthermore, with the master loop MV\_BMPL in cascade control authorized, the master loop senses the state of the slave loop and generates a smoothly continuing control output.

### (16) PIDn\_ERR (PID ERRor value) - Setting Prohibited

K DEVICE AREA : K1042+32n

Unit : DINT [ -2747483648 ~ 2747483647 ]

This is the current error value of the corresponding loop.

An error value in PID is defined as  $SV - PV$ . This is used as an indicator of how far the current state is from the desired state. If the error is 0, it means the control system reaches its desired state. The control system can be considered ideal if, when a control starts, the error rapidly decreases in the transient state and, when it reaches the normal state, vibration is minimized and the offset (the error in the stable state) is kept at 0.

### (17) PIDn\_MV\_p (PID MV Propotional component) - Setting Prohibited

K DEVICE AREA : K1044+32n

Unit : REAL [ -3.40282347e+38 ~ -1.17549435e-38 , 0 , 1.17549435e-38 ~ 3.40282347e+38 ]

This displays the proportional control value of the corresponding loop. If the error of the current system is known, its integral and derivative control output values can also be calculated independently. Comparing the 3 output values enables to determine the exact operational state of the control system and PID control. MV is the sum of MV\_p, MV\_i, and MV\_d.

### (18) PIDn\_MV\_i (PID MV Integral component) - Setting Prohibited

K DEVICE AREA : K1046+32n ~ K1047+32n

Unit : REAL [ -3.40282347e+38 ~ -1.17549435e-38 , 0 , 1.17549435e-38 ~ 3.40282347e+38 ]

This displays the integral control value of the corresponding loop.

### (19) PIDn\_MV\_d (PID MV Derivative component) - Setting Prohibited

K DEVICE AREA : K1048+32n ~ K1049+32n

Unit : REAL [ -3.40282347e+38 ~ -1.17549435e-38 , 0 , 1.17549435e-38 ~ 3.40282347e+38 ]

This displays the derivative control value of the corresponding loop.

### (20) PIDn\_DB\_W (PID DeadBand Width) - Setting Area

K DEVICE AREA : K1050+32n

Unit : WORD [ 0 ~ 65535 ]

This sets the deadband of the corresponding loop. The deadband is set to a positive value and operates in the range from  $[SV - DB\_W] \sim [SV + DB\_W]$ . If PV enters the area, SV is assigned to the PV value. If this value is set to 0, the corresponding function does not operate.

#### Note

##### Deadband

This is used to let PV fully approach SV during system control so as to eliminate fine output variations due to fine state changes. Input of a value to DB\_W during PID control forms a deadband from  $[SV - DB\_W] \sim [SV + DB\_W]$ . If PV follows SV into the deadband during control, ERR is forcibly calculated as 0 and, as far as PV remains in this area, the MV variation stops. This has the same effect as stopping the controller for a while in the stabilization area and helps avoiding a heavy load on the driver during stabilization operation. It is recommended to fully stabilize the system before use in the area to be set as the deadband. Otherwise, when entering the deadband, the controller experiences a temporary output excess.

### (21) `_PIDn_Td_lag` (PID Td lag filter)

- Setting Area

K DEVICE AREA : K1051+32n

Unit : WORD [ 0 ~ 65535 ]

This sets the primary delay filter for the corresponding loop so as to allow the derivative effect acting as an instantaneous impact to act more slowly and continuously. If the corresponding value is set high, the derivative effect becomes smoother and, if it set to 0, the corresponding function does not operate. The derivative value leads the system output to low vibration and helps avoid a heavy load on the driver.

### (22) `_PIDn_AT_HYS_val` (PID Auto-Tuning HYSteresis value)

- Setting Area

K DEVICE AREA : K1052+32n

Unit : INT [ -32768 ~ 32767 ]

This sets a directional deadband appropriate for AT. The `_PIDn_AT_HYS_val` value operates differently as an upper deadband when PV increases and as a lower deadband when PV decreases. Proper setting of this value is critical for successful AT. Setting `_PIDn_AT_HYS_val` is described in 10.7.4.

### (23) `_PIDn_AT_SV` (PID Auto-Tuning SV)

- Setting Area

K DEVICE AREA : K1053+32n

Unit : INT [ -32768 ~ 32767 ]

This separately sets `AT_SV` to be used as SV for AT of the corresponding loop. AT enables PV to vibrate 3 times up and down around `AT_SV`.

### (24) `_PIDn_AT_step` (PID Auto-Tuning step)

- Setting Prohibited

K DEVICE AREA : K1054+32n

Unit : INT [ -32768 ~ 32767 ]

This displays the AT operation state of the corresponding loop. `_PIDn_AT_step` has values from 0 to 7; 0 indicates "before AT operation" and 7 indicates "AT operation completed". 1, 3 and 5 indicate the PV-increasing areas and 2, 4 and 6 indicate the PV-decreasing area.



## Caution

- 1) **Setting Prohibited** : The items marked with **- Setting Prohibited** are prohibited from being set by the user. The corresponding area not only provides the user with operational information but also stores information necessary for operations. A random setting of the corresponding area causes the malfunction of the control system.
- 2) **Input/Output Area** : `_PIDn_PV` and `_PIDn_MV` belong to **- Input/Output Area**, so use them in a way they are connected to external equipment (AD, DA device).

### Note

#### Transient and Normal States

- 1) Transien State : A state during which the control system starts its control operatoin and reaches the desired control state; there often occurs an instantaneous output variation and, while the integral value approaches stability, there may occur a vibration or overshoot.
- 2) Normal State : A state during which the control system reaches the desired state after passing through the transient state; vibration is eliminated, there may occur an offset and there is little change in the output value.

#### Upper / Lower Deadbands

When the analog output of the sensor is converted into a digital signal by means of an AD device, much of the signal is mixed with noise. The PID control instruction executes Auto-tuning using this converted value; it enables PV to increase and dedcrease 3 times up and down at SV. In the course of this process, if noise is input at the time when SV equals PV, a single up and down conversion is incorrectly perceived as multiple conversions. This is the same effect as the chattering of the digital switch. To overcome this, the PID controller uses a unidirectional deadband (Hysteresis); when the PV value of the system increases toward SV, the set deadband value operates in the upper part of SV and when the PV value passes SV and decreases, the set deadband value operates only in the lower part of SV.

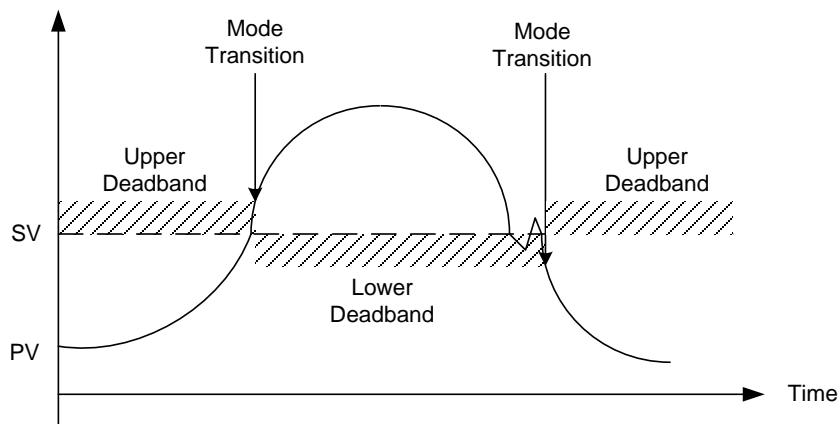

### 10.6 Convenient Additional Functions of PID Instructions

This section describes additional functions that can be conveniently used in combination with the PID instructions.

#### 10.6.1 Various PID-based control methods

Commonly used among PID controls are P control, PI control, PD control and PID control. When a certain feature (mostly stabilization) is required, ID control, I control or D control is often used though they are somehow more complicated. To implement these various controls, PIDRUN includes functions that allow or prevent controls by P, I, and D, respectively. In case of P control, the P controller can be configured by setting `_PIDn_Ti` and `_PIDn_Td` to 0. Similarly, the ID controller can be obtained by setting `_PIDn_Kp` to 0 and assigning ID control coefficients to `_PIDn_Ti` and `_PIDn_Td`.

One special thing about the PIDRUN instructions is that, in case of ID control, setting `_PIDn_Kp` to 0 theoretically results in the controller output of 0. (Refer to Expressions 10.3.2 ~ 10.3.5) Actually, however, PIDRUN, if 0 is input to `_PIDn_Kp`, internally calculates as  $MV_p = 0$  and  $K_p = 1$ , thus enabling ID, I control and D control.

For example, when PI control is required, only `_PIDn_Kp` and `_PIDn_Ti` are set and 0 is input to `_PIDn_Td`. When ID control is required, `_PIDn_Kp` is set to 0 and only `_PIDn_Ti` and `_PIDn_Td` are set.

#### 10.6.2 Operation and function of anti wind – up

PIDRUN provides 2 Wind-up prevention functions: Anti Wind-up 1 and Anti Wind-up 2. The more basic of the two, Anti Wind-up 1 operates for all I-related controls - I control, PI control, ID control and PID control - and cannot be cleared. This operates by limiting  $MV_i$  (the integral term results) using `_PIDn_MV_max`, `_PIDn_MV_min`.

Anti Wind-up 2 is organically connected to  $MV_p$  (the proportional term results). In case  $MV$  reaches  $\pm$  (`_PIDn_MV_max`) on  $MV_p$  only, regardless of the  $MV_i$  and  $MV_d$  values, due to a large system error,  $MV_i$  does not perform a calculation but keeps the previous value. In case the error is large,  $PV$  is brought near  $SV$  (operating point) by  $MV_p$ , not by  $MV_i$  or  $MV_d$ , and then I control is resumed to prevent an excessive value from being entered into  $MV_i$ . The operation of Anti Wind-up 2 can be cleared by the user by setting the `_PIDn_AW2D` bit on the common bit area to On. This operates only during PI control or during a control combining P control and I control, e.g. PID control.

#### 10.6.3 Operation and function of Auto-tuning (AT)

PIDRUN has an AT function that enables to test operate the system through several basic settings and calculate `_PIDn_T_s`, `_PIDn_K_p`, `_PIDn_T_i` and `_PIDn_T_d` appropriate for the system. The values of `_PIDn_MV_min`, `_PIDn_MV_max`, `_PIDn_AT_HYS_val`, and `_PIDn_AT_SV` should be set before AT. Based on these values, the AT function sets and operates  $MV$  over 3 different times in order, examines the repeated system state ( $PV$ ) reaction, measures the time taken for the system state ( $PV$ ) to reach the AT Set Value (`AT_SV`) and the vibration level, and accordingly calculates `_PIDn_T_s`, `_PIDn_K_p`, `_PIDn_T_i` and `_PIDn_T_d`. To calculate the exact tuning value, please refer to "AT Setting" in 1.7.4 for proper AT operation.

#### Note

##### Deletion of Previous Data upon Completion of Auto-tuning (AT)

When the AT operation described in 10.6.3 is completed, the new values of `_PIDn_T_s`, `_PIDn_K_p`, `_PIDn_T_i` and `_PIDn_T_d` are automatically substituted for the existing values. Note, therefore, that the previous value of `_PIDn_T_s`, `_PIDn_K_p`, `_PIDn_T_i` and `_PIDn_T_d` are deleted.



### 10.6.4 Operation and function of cascade (CAS)

PDCAS performs cascade PID control through sequential operation of two PID loops. Generally, cascade PID control is used for temperature control through chemical process or fuel control; The two loops used here are called master loop and slave loop. As an example of temperature control through fuel flow, in case of a single loop PID control, the fuel valve is opened and closed to control the fuel flow and consequently control the temperature of the heating furnace. This is, therefore, a system in which a single PID loop indirectly controls temperature through fuel flow control. In this case, equipping the system with a fuel flow meter enables cascade PID control that consists of flow control and temperature control: the slave loop controls the flow using the valve and the master loop controls temperature using the flow. The master loop transfers the desired flow to the slave loop, while the slave loop monitors the flow meter and adjusts the flow using the valve so that fuel corresponding to the flow desired by the master loop is injected. The slave loop operates on the flow Set Value set by the master loop, regardless of temperature.

In terms of the internal cascade operation, the master loop measures the temperature (PV\_mst) in a more delayed manner than the slave loop and transfers the flow value (MV\_mst) computed for the user's desired temperature (MV\_mst) to the slave loop. The slave loop sets the flow value (MV\_mst) transferred from the master loop as the Set Value (SV\_slv) and measures the fuel injection amount (PV\_slv) in a more frequent manner than the master loop in order to control the valve opening and closing (MV\_slv).

Cascade, therefore, functions to transfer MV (MV\_mst) of the master loop to SV (SV\_slv) of the slave loop when two loops are in operation.

If the slave loop is converted to manual output mode, the master output is not used and the master loop is also converted to manual output mode. The manual mode `_PIDn_MAN` bit is not turned ON in the master loop. If the slave loop is converted to auto output mode again, the master loop is also turned to auto output mode. If `_PIDn_MV_BMPL` is set to On, state data is exchanged between the two loops to ensure a smooth conversion.

If the slave loop is in Anti Wind-up mode, the master loop operates in PIDPAUSE mode. When there is a need to increase or decrease the slave Set Value (SV\_mst) despite the occurrence of anti wind-up, this function prevents the occurrence of 2<sup>nd</sup> wind-up for the whole cascade loop. This function always operates according to the corresponding conditions and the `_PIDn_PAUSE` bit is not turned On.

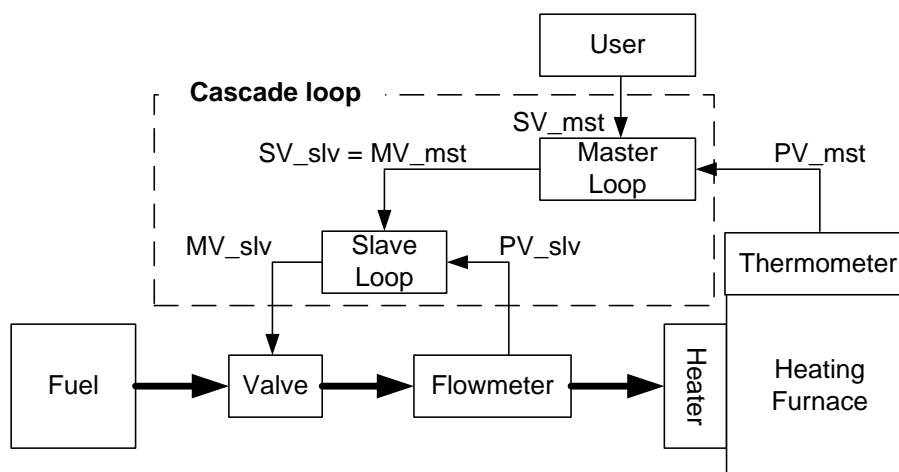

#### Note

#### Auto-tuning (AT) of Cascade System

In case of AT of a cascade system, AT of the slave loop precedes AT of the master loop. For AT of the slave loop, it is required to predict how much SV the slave loop receives from the master loop and setting `AT_SV` to this value enables the slave loop to operate as an independent loop. AT performance may differ according to the predicted value. Upon completion of AT of the slave loop, AT of the master loop starts.

### 10.7 How to Use PID Instructions

This section describes how to use PID instructions. For detailed description of the functions of the CPU, specific modules and XG5000, refer to the corresponding manuals.

#### 10.7.1 Hardware configuration

The example system has a configuration as shown below.

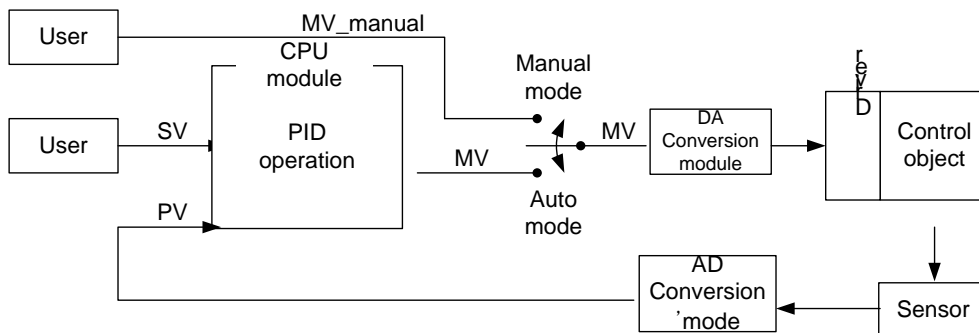

#### (1) CPU (XGK-CPUH)

The CPU is where PID operation occurs and so can be called “PID controller”. The controller receives data sensed from the input module, calculates a proper output through operation, and then transfers it to the output module. What the user should do is to connect input and output and design the interior of the PID controller (tuning). Generally, analog input module and analog output modules are used for input and output, respectively.

#### (2) Analog Input Module (XGF-AV8A)

This functions to receive the state of the control object from the sensor and transfer it to the CPU. The analog input module channel 0 enables to receive a voltage of 0 V ~ 5 V as input and transfer its digital value to the PLC as output. There are 8 channels (CH 0 ~ CH 7) in XGF-AV8A. The setting for XGXF-AV8A can be changed through the I/O parameter setting window that appears when selecting I/O Parameter from the parameter items in the project window. Channel 0 is changed to “Operation” mode and the input range is set to 0 ~ 5 V (according to the sensor). The output data type is the PV value of the PID controller. For PID control, the range of its value is set to 0 ~ 10000.

The 0 ~ 5 V signal detected from the sensor during analog input module operation is converted 2,000 times to a digital value of 0 ~ 10000 and then transferred to the PLC.

## Chapter 10 Built-in PID Functions

The following figure shows the screen of XGF-AV8A setting in XG5000.

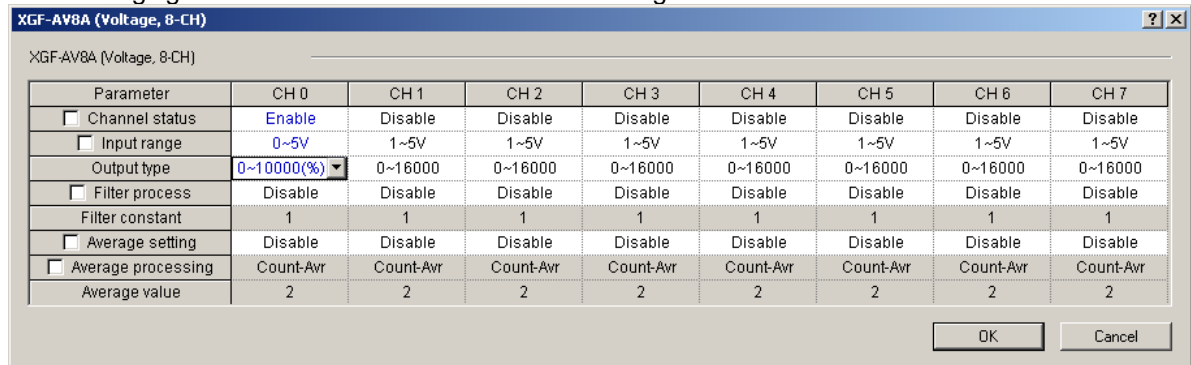

### (3) Analog output Module (XGF-DV4A)

The analog output module converts a controller output digital value generated through control operation in the PLC to 4mA ~ 20mA and transfers it to the driver of the control object. The XGF-DV4A model has 4 channels and its setting can be changed through the I/O parameter setting window, as in XGXGF-AV8A. Channel 0 is changed to "Operation" mode and the input range is set to 0 ~ 5 V (according to the driver). The 0 ~ 10000 MV digital output generated through PID control operation is reduced to 1/2000 and then transferred to the signal of the driver. The following figure shows the screen of XGF-DV4A setting in XG5000.

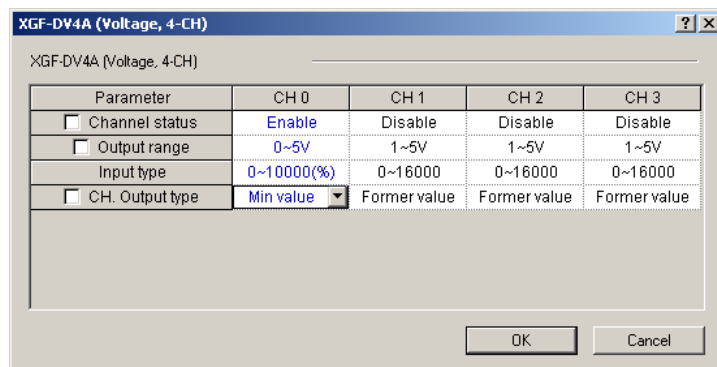

### (4) Sensor and Driver

Along with the analog output module and analog input module, the sensor and driver respectively function as the media to transfer the state of the control object to the controller and transfer the controller output to the control object. The output generated from the sensor should be able to be used as the input of the analog input module and the output generated from the analog output module should be able to be used as the input of the driver. For an easy example, if the sensor's current mode is 4mA ~ 20mA, the analog input module's current mode should be 4mA ~ 20mA; if the driver's voltage mode is 0V ~ 5V, the analog output module's voltage mode should be 0V ~ 5V. The output of the analog output module used as the driving signal of the driver. Using it as the power of the driver may cause malfunction of the PLC due to power loss.

# Chapter 10 Built-in PID Functions

## (5) Control Object

The current system uses a water level control system as the control object. A water level control system is a stem to maintain a desired water level by pumping water into a water tank whose lower part has a small opening for outflow of water. The water in the tank flows out at a constant rate. The decision to increase or decrease the water level is based on the water inflow. The structure of a water level control system is shown below.

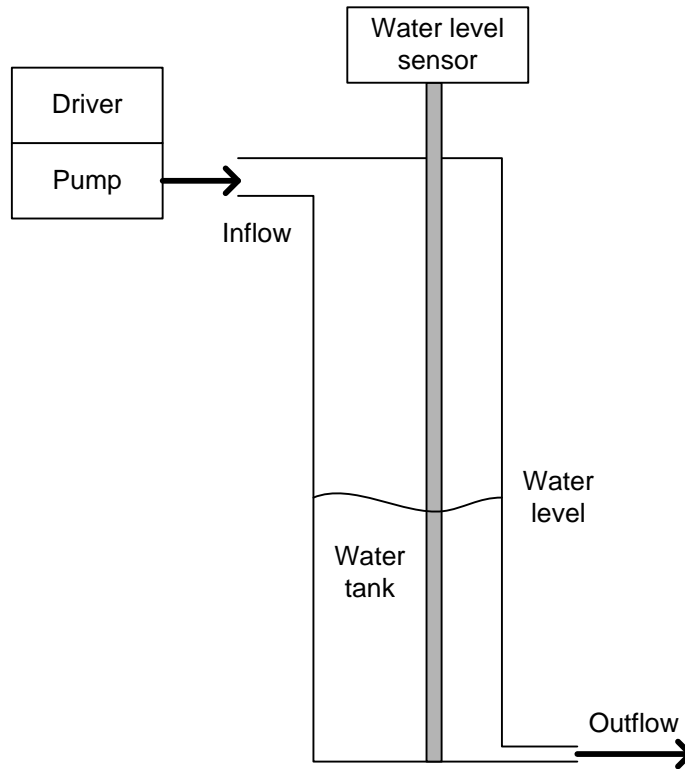

### 10.7.2 Program example 1

The following figure shows a program example of performing PID control using analog modules. (In this program, the PID constant value and SV value are set in the Variable Monitor window.)

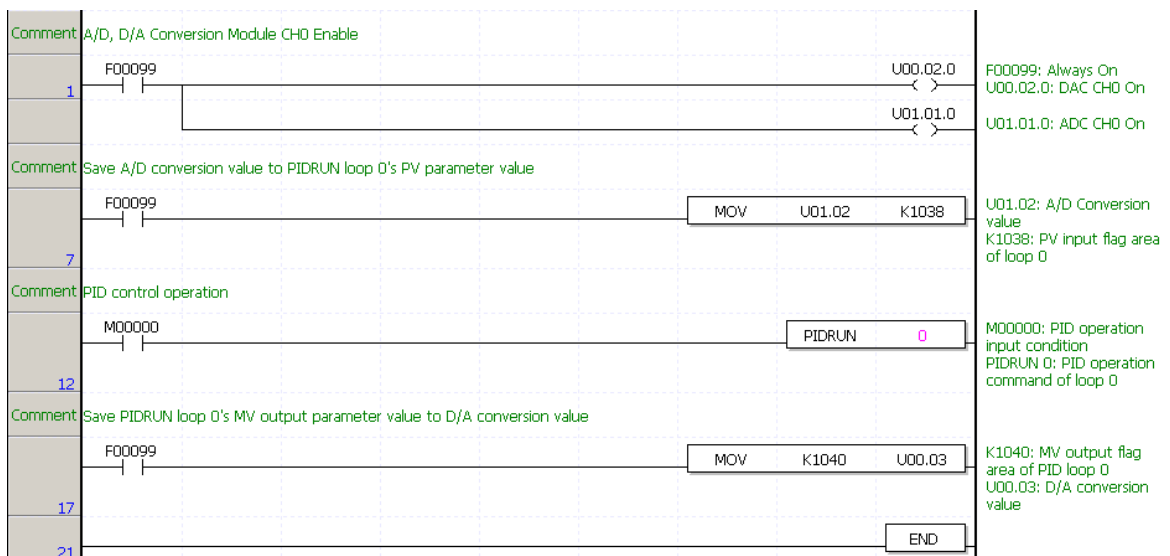

## Chapter 10 Built-in PID Functions

- Step 1: Each channel 0 of the analog input and output modules is enabled using the regular On contact.  
 Step 7: The analog input module input data are transferred to PIDRUN Loop 0 PV using the regular On contact.  
 Step 12: If the user turns the M0000 bit On, control operation of PIDRUN Loop 0 is performed.  
 Step 17: MV output of PIDRUN Loop 0 is transferred to analog output module output data.  
 Step 21: The scan is completed.

### 10.7.3 PID controlling

#### (1) Variable Registration

Control settings is performed by registering PID variables in the Variable Monitor” window. Clicking the right button of the mouse and then selecting “Register in Variable/Description” in the Variable Monitor window allows you to see the “Variable/Device Select” window. Selecting PID in the “List” box and deselecting “All” and then entering 0 (loop number) in “Parameter Number” allows you to see the variables to store all the settings and states for Loop 0. Selecting all variables and then clicking “Confirm” enables you to monitor the variables or change their values even when the program is in “RUN” mode.

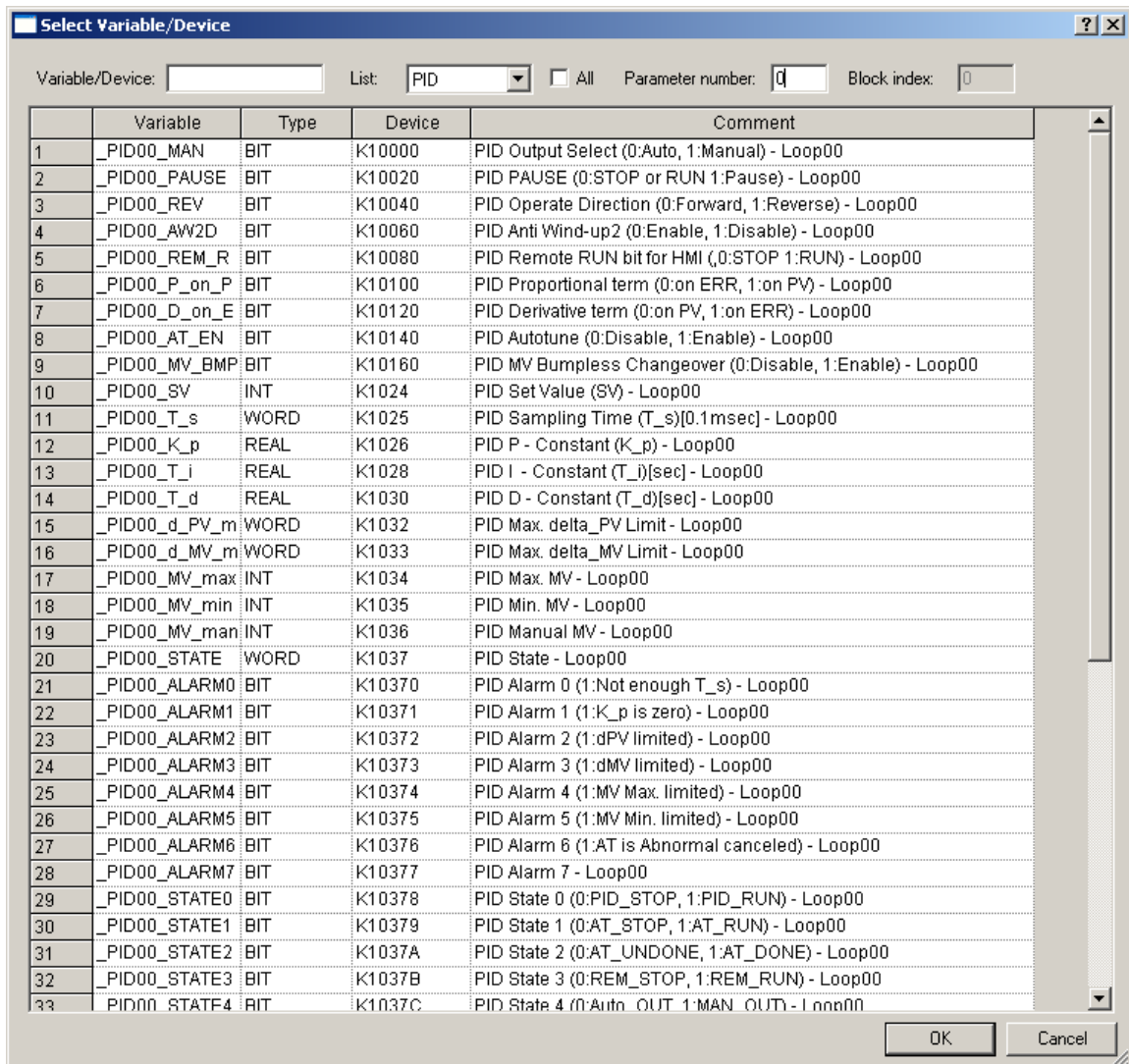

## Chapter 10 Built-in PID Functions

### (2) Determination of SV

In order to set SV, the PV value of the system desired by the user should be determined. To put it easily, in order to maintain the water level at 250mm, the PV value for 250mm should be determined. This value can be determined through numerical analysis of the system but it will be more exactly determined by experimenting with the reaction of the control object. Analysis with the current system suggests that, with the water level of 250mm, PV outputs the value of 8333, but an actual operation showed that, with the water level of 250mm, the sensor output value was 3250. The reasons for such an error are the inaccuracy of the sensor, the error of the measuring base point, etc. So, the actually measured value of 8250 should be used as the state value when the water level is 250mm. This value will be used as the SV value for control of 250mm.

### (3) Control Setting

After the previously developed program is downloaded to the PLC, then monitoring begins. The next step is to set the variables registered in the Variable Monitor window. The following figure shows the screen of settings in the Variable Monitor window of the example program.

	PLC	Type	Device	Value	Variable	Comment
1	NewPLC	BIT	K10000	10	_PID00_MAN	PID Output Select (0:Auto, 1:Manual) - Loop00
2	NewPLC	BIT	K10020	10	_PID00_PAUSE	PID PAUSE (0:STOP or RUN 1:Pause) - Loop00
3	NewPLC	BIT	K10040	10	_PID00_REV	PID Operate Direction (0:Forward, 1:Reverse) - Loop00
4	NewPLC	BIT	K10060	10	_PID00_AW2D	PID Anti Wind-up2 (0:Enable, 1:Disable) - Loop00
5	NewPLC	BIT	K10080	10	_PID00_REM_RUN	PID Remote RUN bit for HMI (0:STOP 1:RUN) - Loop00
6	NewPLC	BIT	K10100	10	_PID00_P_on_PV	PID Proportional term (0:on ERR, 1:on PV) - Loop00
7	NewPLC	BIT	K10120	10	_PID00_D_on_ERR	PID Derivative term (0:on PV, 1:on ERR) - Loop00
8	NewPLC	BIT	K10140	10	_PID00_AT_EN	PID Autotune (0:Disable, 1:Enable) - Loop00
9	NewPLC	BIT	K10160	10	_PID00_MV_BMPL	PID MV Bumpless Changeover (0:Disable, 1:Enable) - Loop00
10	NewPLC	INT	K1024	10	_PID00_SV	PID Set Value (SV) - Loop00
11	NewPLC	WVOR D	K1025	10	_PID00_T_s	PID Sampling Time (T_s)[0.1msec] - Loop00
12	NewPLC	REAL	K1026	10	_PID00_K_p	PID P - Constant (K_p) - Loop00
13	NewPLC	REAL	K1028	10	_PID00_T_j	PID I - Constant (T_j)[sec] - Loop00
14	NewPLC	REAL	K1030	10	_PID00_T_d	PID D - Constant (T_d)[sec] - Loop00
15	NewPLC	WVOR D	K1032	10	_PID00_d_PV_max	PID Max. delta_PV Limit - Loop00
16	NewPLC	WVOR D	K1033	10	_PID00_d_MV_max	PID Max. delta_MV Limit - Loop00
17	NewPLC	INT	K1034	10	_PID00_MV_max	PID Max. MV - Loop00
18	NewPLC	INT	K1035	10	_PID00_MV_min	PID Min. MV - Loop00
19	NewPLC	INT	K1036	10	_PID00_MV_man	PID Manual MV - Loop00
20	NewPLC	WVOR D	K1037	10	_PID00_STATE	PID State - Loop00
21	NewPLC	BIT	K10370	10	_PID00_ALARM0	PID Alarm 0 (1:Not enough T_s) - Loop00
22	NewPLC	BIT	K10371	10	_PID00_ALARM1	PID Alarm 1 (1:K_p is zero) - Loop00
23	NewPLC	BIT	K10372	10	_PID00_ALARM2	PID Alarm 2 (1:dPV limited) - Loop00
24	NewPLC	BIT	K10373	10	_PID00_ALARM3	PID Alarm 3 (1:dMV limited) - Loop00
25	NewPLC	BIT	K10374	10	_PID00_ALARM4	PID Alarm 4 (1:MV Max. limited) - Loop00
26	NewPLC	BIT	K10375	10	_PID00_ALARM5	PID Alarm 5 (1:MV Min. limited) - Loop00
27	NewPLC	BIT	K10376	10	_PID00_ALARM6	PID Alarm 6 (1:AT is Abnormal canceled) - Loop00
28	NewPLC	BIT	K10377	10	_PID00_ALARM7	PID Alarm 7 - Loop00
29	NewPLC	BIT	K10378	10	_PID00_STATE0	PID State 0 (0:PID_STOP, 1:PID_RUN) - Loop00
30	NewPLC	BIT	K10379	10	_PID00_STATE1	PID State 1 (0:AT_STOP, 1:AT_RUN) - Loop00

Settings were made for SV, K<sub>p</sub>, and MV<sub>max</sub>.

The actually measured value of 8250 was set for SV and 5 was randomly selected for K<sub>p</sub>.

MV<sub>max</sub>, an item to limit the maximum value of MV, was set to 10000 according to the analog module.

## Chapter 10 Built-in PID Functions

### (4) Observation of Control States Using the Trend Monitor

You can enable the trend monitor, one of the monitor functions of XG5000.

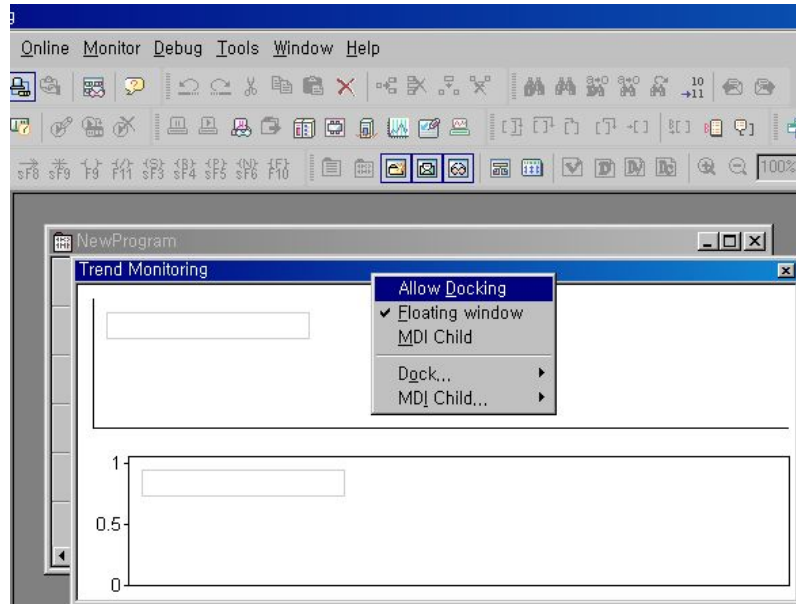

The trend monitor can be properly arranged by allowing its docking.

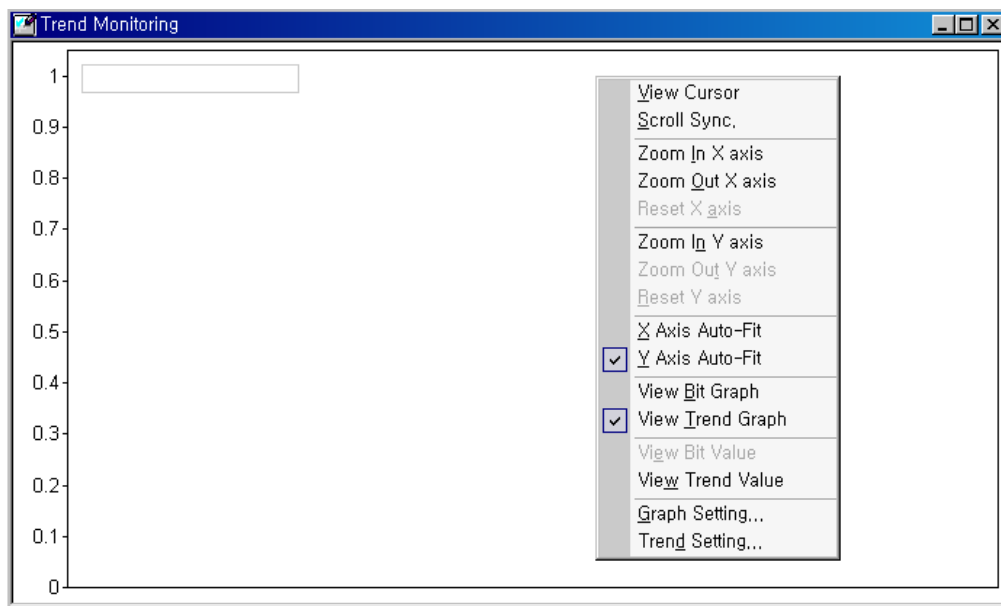

Data to be observed are registered through the trend setting.

## Chapter 10 Built-in PID Functions

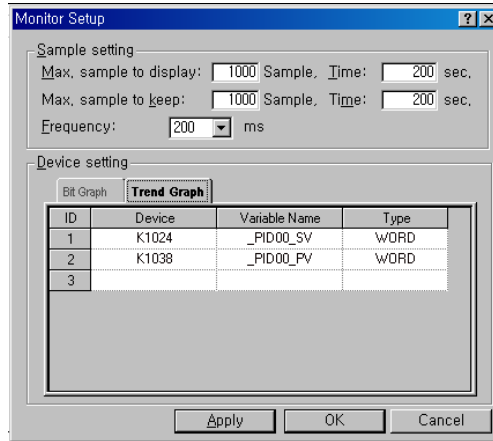

The monitoring cycle is set to 200m and, after the trend graph tap in the lower part is selected, SV and PV of Loop 0 are registered as INT.

**(5) Program Run** (Here an example is given to show how to find a parameter manually. For auto tuning, refer to the method below.)

When the contact (M0000) is turned On, the system starts up.

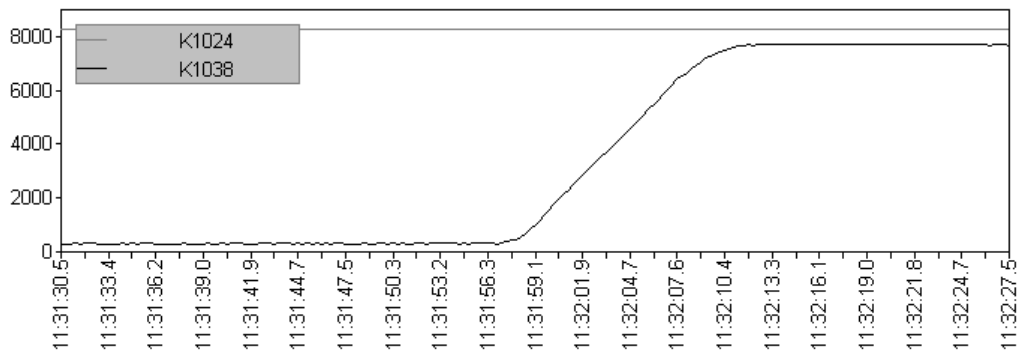

After increasing  $K_p$  to 100, the system is started again.

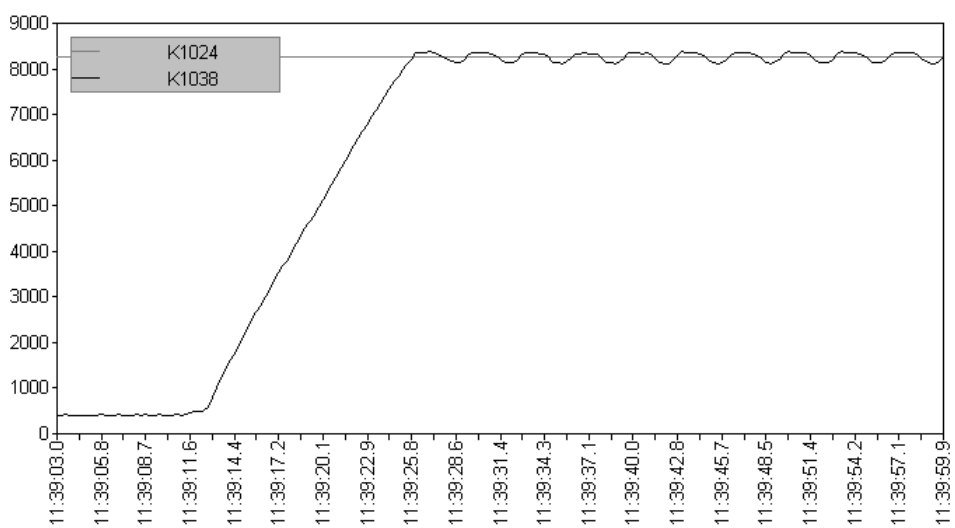

Because  $K_p$  is set too large, the system vibrates in a permanent and regular manner. Settings are made as follows:  $K_p = 20$ ,  $T_i = 100$



## Chapter 10 Built-in PID Functions

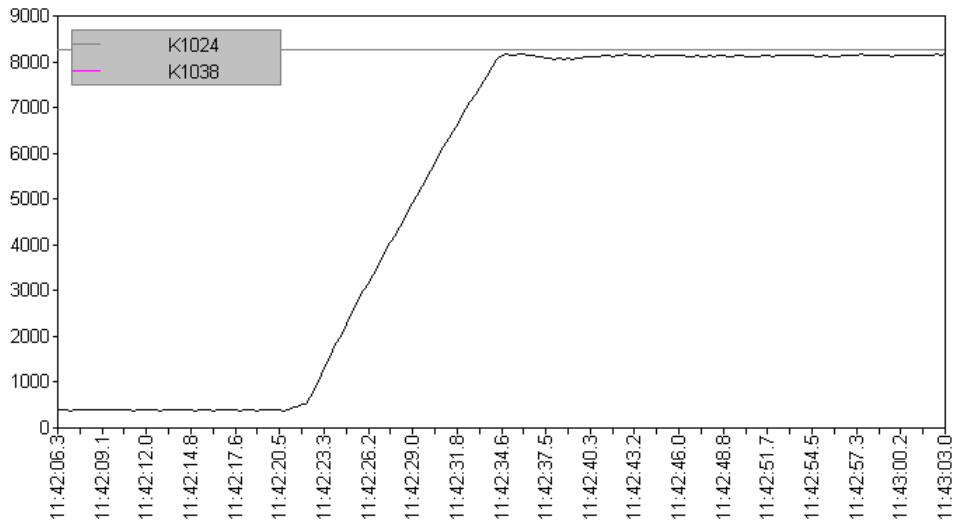

Because the  $T_i$  value is too large, the normal state offset lasts long and there occurs a slight overshoot.

Settings are made as follows:  $K_p = 10$ ,  $T_i = 1$ .

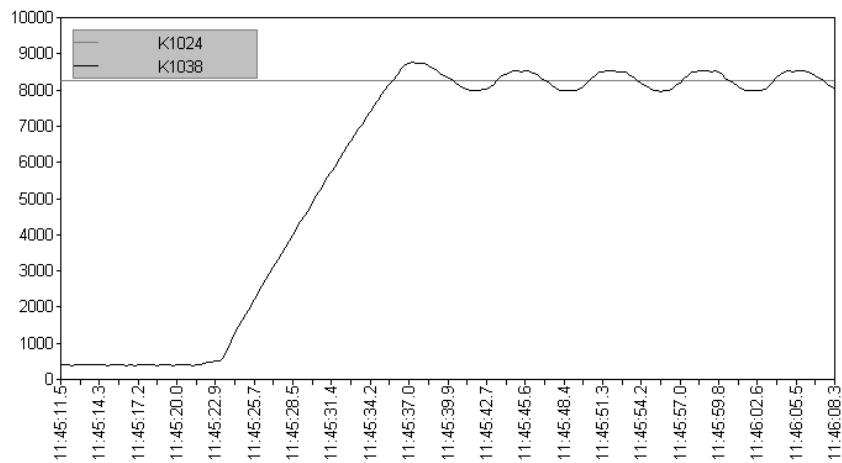

Because  $T_i$  is too small, PV fluctuates slowly.

Settings are made as follows:  $K_p = 10$ ,  $T_i = 5$

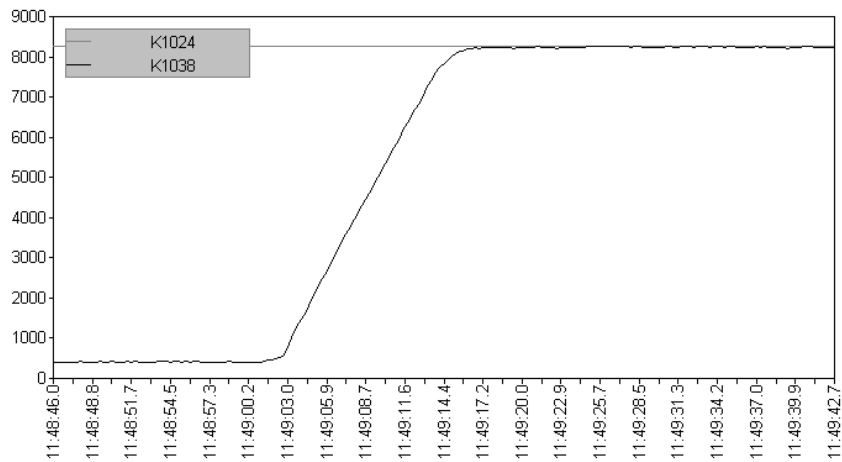

This is a satisfactory result.  
After changing  $T_d$  to 0.1, the system is started again.

## Chapter 10 Built-in PID Functions

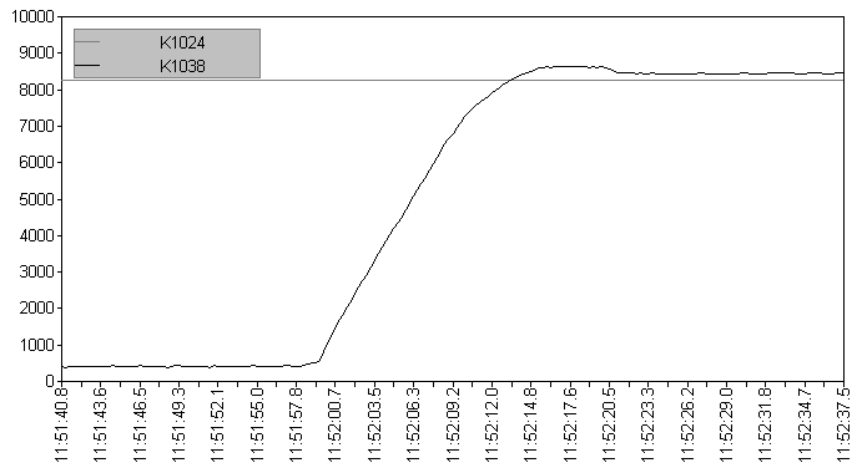

The system rocks and the error increases.

Since the current system is a slow system that can be fully controlled by PI, only PI control is required.

Therefore, the tuning results are as follows:  $K_p = 10$ ,  $T_i = 5$ ,  $T_d = 0$

10.7.4 How to start up using AT (Auto-tuning)

This section explains the correct AT setting method through operating the system described in 10.7.3 using the AT function. The basic AT function properly operates when the system is not started yet or when the system has PV at least smaller (larger in case of reverse operation) than the `_PIDn_AT_SV` value. Basically, AT performs different operations in different steps. The step increases from 0 to 7 and the step of the current loop can be known by `_PIDn_AT_step`. In PIDSTOP mode, the AT step is 0 and increases (automatically) as AT starts. When it reaches 7, AT is completed. The user's random manipulation of the step may cause malfunction.

To avoid redundant descriptions, the procedures from 10.7.3 (1) to (4) are first implemented and then the present settings are applied. First, `_PIDn_AT_SV` is set. Though the `_PIDn_SV` value has been already set above, the system is vibrated during Auto-tuning so that PV is more than the `_PIDn_SV` value. To prevent any harm to the system in the course, an appropriate SV value should be set in `_PIDn_AT_SV`. For other cases, `_PIDn_AT_SV` should be set the same with `_PIDn_SV`. The `_PIDn_AT_SV` value is used only during AT and, upon completion of AT, the system is automatically started based on `_PIDn_SV`. Next, `_PIDn_MV_min` and `_PIDn_MV_max` are set. During AT, the `_PIDn_MV_min` and `_PIDn_MV_max` values are respectively considered as the minimum/maximum output of the system. During AT, the two values differ each other in 3 cycles depending on the system speed (how fast PV reaches around SV). For example, with `_PIDn_MV_min = 0`, `_PIDn_MV_max = 10000`, the system driving signal (MV) transferred to the motor or heater repeats the "0 → 10000 → 0" output 3 times. If there is a possibility that such a radical change may put a heavy load on the system, `_PIDn_dMV` should be set.

Next, the `PIDn_HYS_val` value is set. `_PIDn_HYS_val` is used only during AT. This is a deadband that occurs when PV reaches around SV. When PV increases, it occurs above the baseline and, when PV decreases, it occurs below the baseline. If SV is 5000 and `_PIDn_HYS_val` is 100, AT increases PV until 5100 (`SV + _PIDn_HYS_val`) while maintaining MV at `_PIDn_MV_max`. Afterward, it decreases PV until 4900 (`SV - _PIDn_HYS_val`) while maintaining MV at `_PIDn_MV_min`.

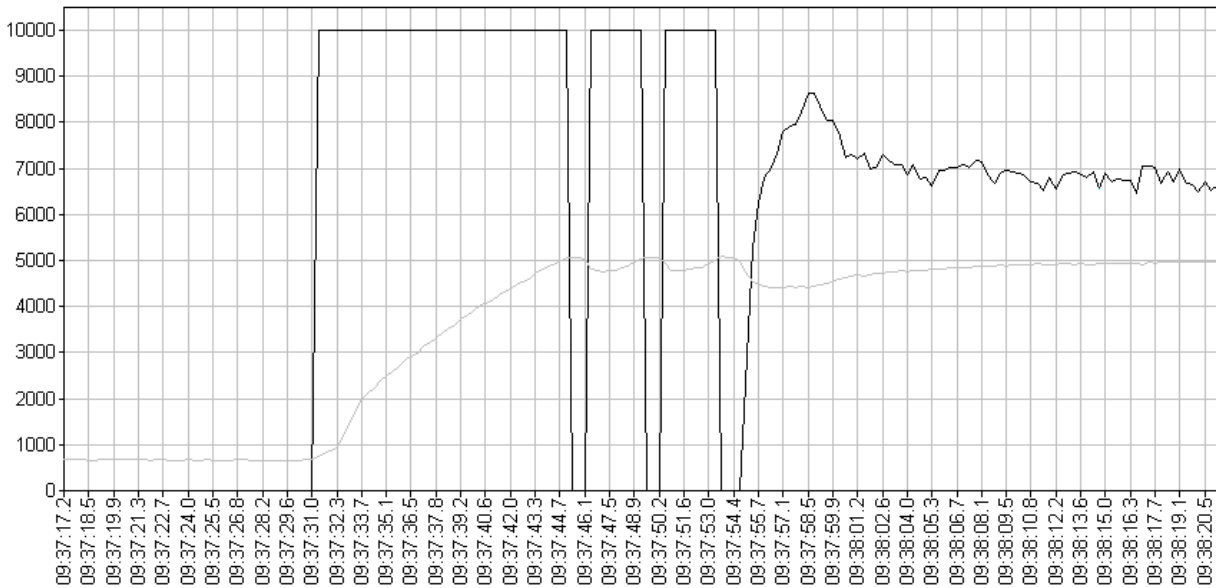

The above graph shows a water level waveform obtained by setting an appropriate `_PIDn_HYS_val` value (50 in the figure). A rectangular waveform should appear in MV 3 times.

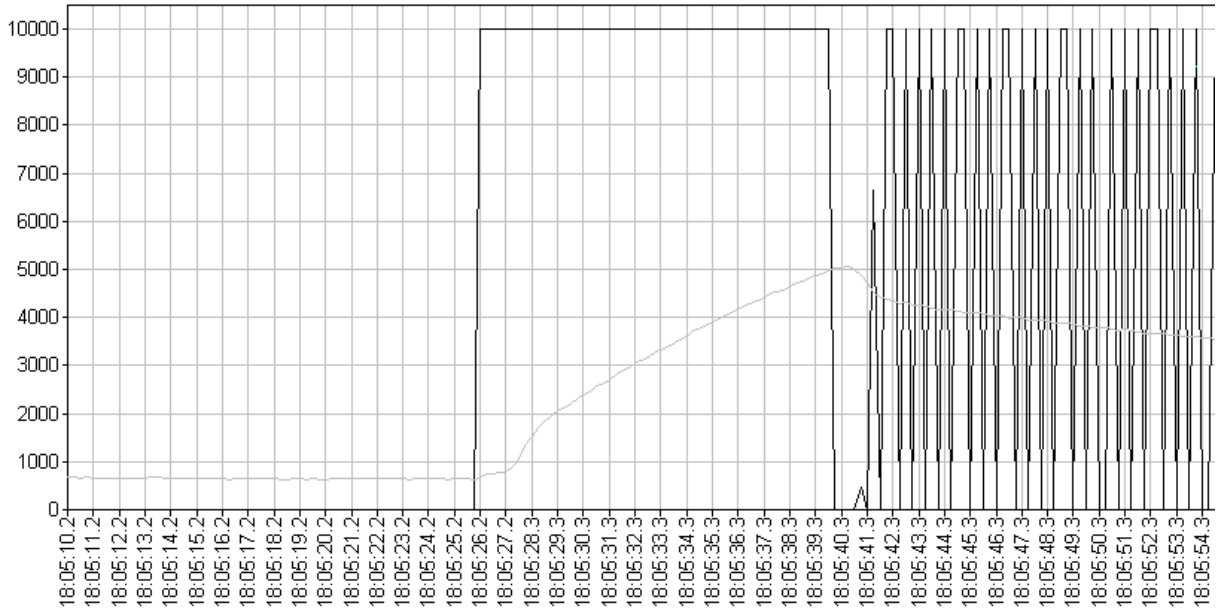

The above graph shows a water level waveform obtained by setting `_PIDn_HYS_val` too small (10 in the figure). If a rectangular waveform does not appear 3 times in MV, a correct AT operation cannot be guaranteed. Setting `_PIDn_HYS_val` too large may cause system slowdown.

### 10.7.5 Program example 2

The following figure shows the screen of the PID constant value and SV value settings in the 10.7.2 program that performs PID control using the A/D and D/A conversion modules.

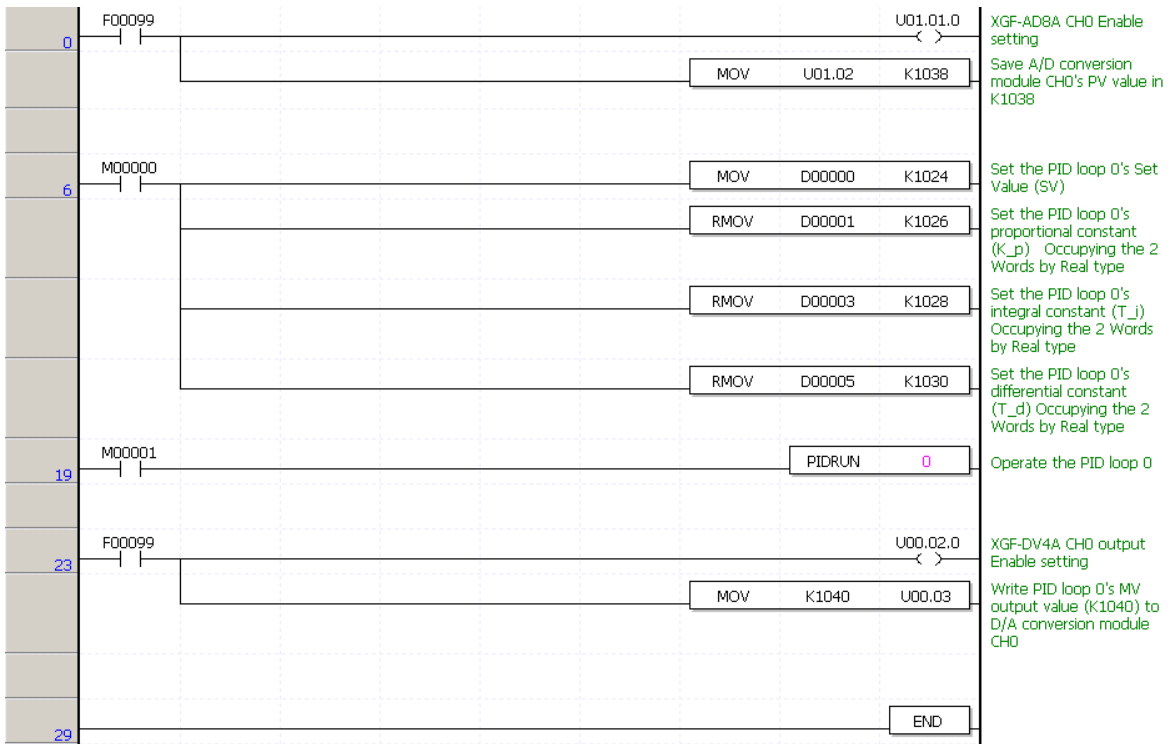

## 10.7.6 Startup using PWM

Input is done using the A/D conversion module as shown in the simulation above and the output signal is converted to PWM to control the system using a relay module or TR module.

The following figure shows a program example of performing PID control using A/D and D/A conversion modules.

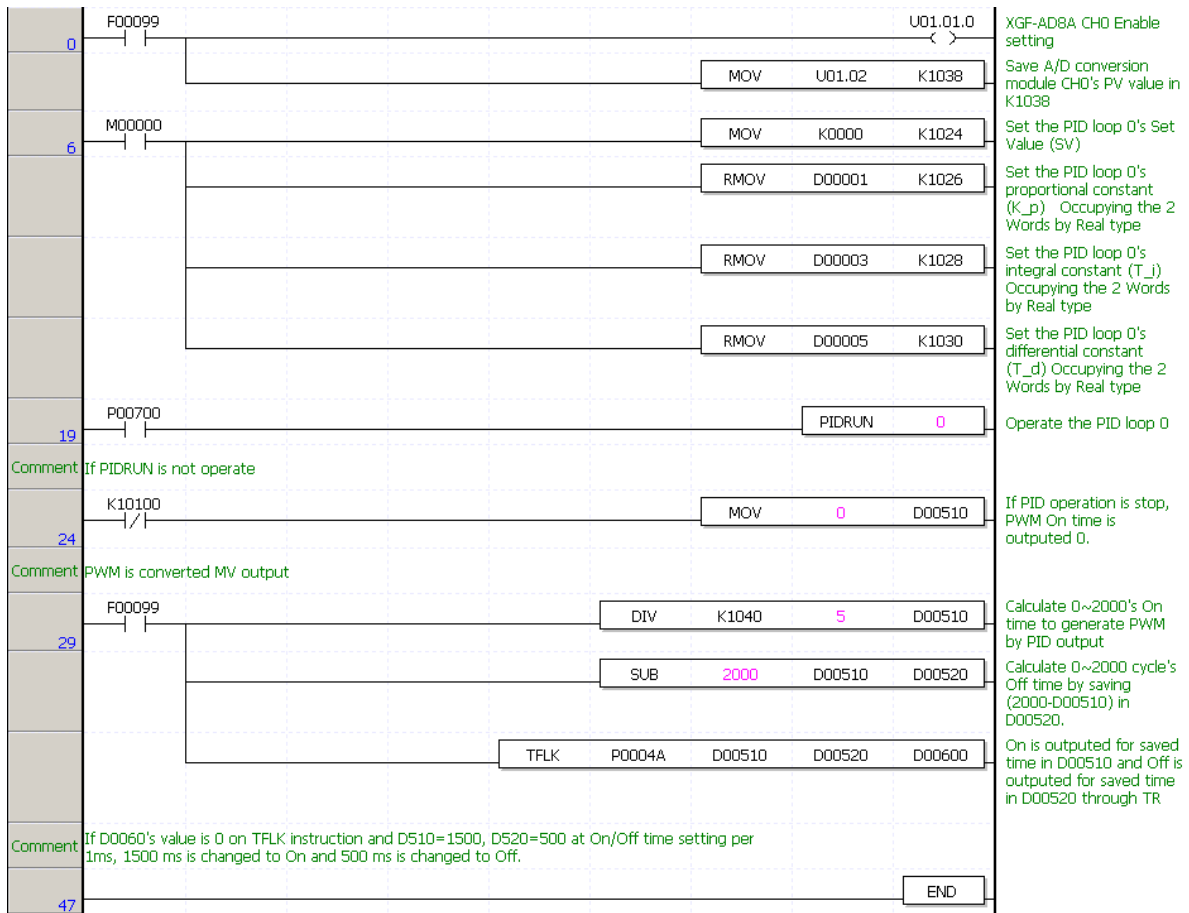

Step 1 : The A/D conversion module channel 0 is enabled using the regular On contact and the A/D conversion module input data are transferred to PIDRUN Loop 0 PV.

Step 7 : If the user turns the P00700 bit On, control operation of PIDRUN Loop 0 is performed.

Step 12 : If PIDRUN Loop 0 is in stop mode, the PWM On time is set to 0 and the output to OFF.

Step 17 : PIDRUN Loop 0 MV output ( 0 ~ 10000 ) is divided by 5 into ( 0 ~ 2000 ) using the regular On contact. D00510 is used as the PWM On time and D00520, the remaining time subtracted from 2000 by D00510, is used as the PWM OFF time.

A PWM signal with a cycle of 20000 (2 sec) can be obtained using D00510 and D00520.

The corresponding output device is driven by controlling the P0004A bit using the generated PWM.

Step 34 : The scan is completed.

10.7.7 Cascade startup

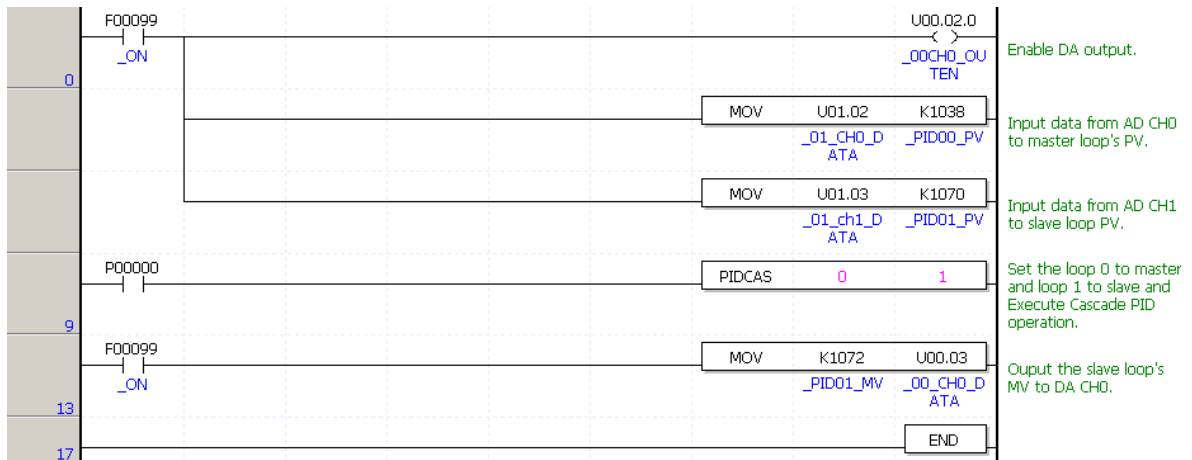

The ladder program above is a cascade startup program based on the block diagram below.

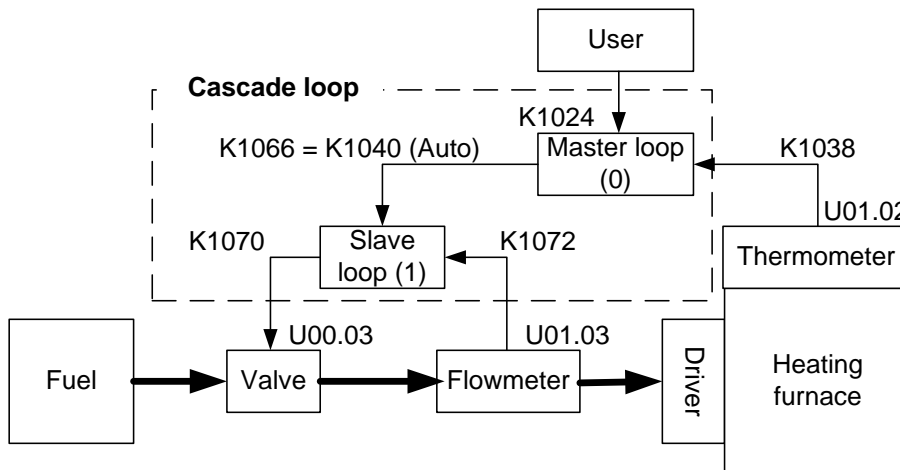

## Chapter 11 Installation and Wiring

### 11.1 Installation

#### 11.1.1 Installation Environment

This equipment has a high reliability regardless the installation environment. However, cares should be taken for the following items in order to secure the reliability and stability.

##### 1) Environment Condition

- (1) Install in control panel with water-proof and vibration-proof.
- (2) Free from impact or vibration.
- (3) Do not expose directly to the sun.
- (4) No condensing by sudden temperature change.
- (5) Ambient temperature : 0 ~ 55°C.
- (6) Incremental Humidity : 5 ~ 95% .
- (7) Free from corrosive gas or inflammable gas

##### 2) Installation Construction

- (1) In case of processing of screw hole or wiring, do not enter the wiring fragments into PLC.
- (2) Select the installation place good for operation.
- (3) Do not install the equipment in the same panel with high voltage device.
- (4) Keep more than 50mm from wiring duct or surrounding module.
- (5) Grounding at the place where surrounding noise environment is good.

##### 3) Heat Protection Design of Control Panel

- (1) In case that PLC is installed in the airtight control panel, the heat protection design shall be carried out considering radiation of other equipment as well as the heat of PLC itself. In case of air circulation using the vent or general fan, PLC system may be influenced by the flow of dust or gas etc.
- (2) It is recommended to install a filter or use the airtight heat exchanger.

## Chapter 11 Installation and Wiring

The following shows the method to calculate the current consumption of PLC system itself necessary for heat protection design.

### 4) Current Consumption Block Diagram of PLC System

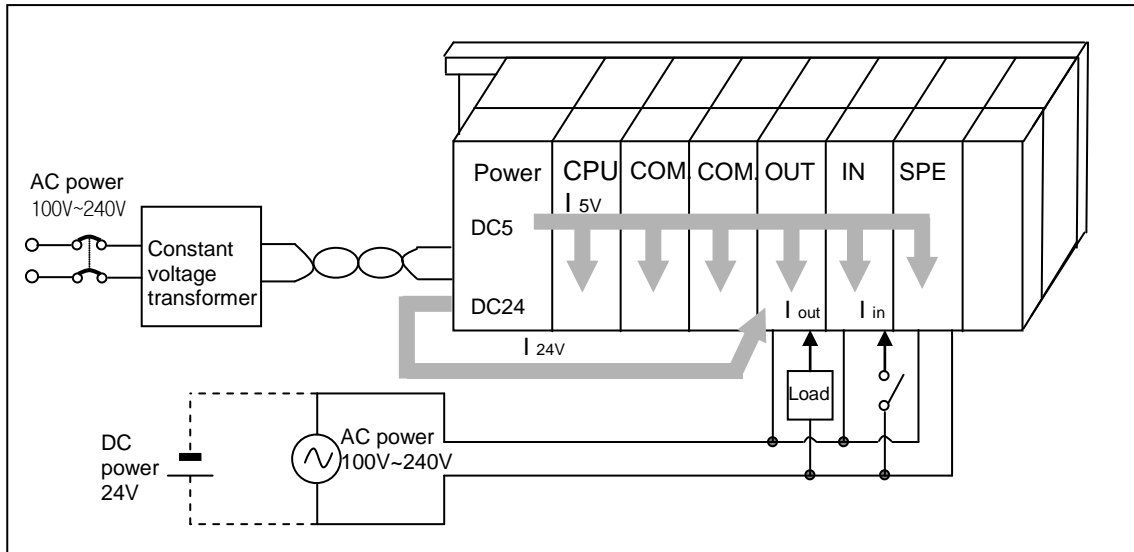

### 5) Current Consumption of Each Part

#### (1) Current Consumption of Power Module

Current conversion efficiency of power module is about 70% and 30% is consumed by the radiation, and 3/7 of output power shall be a current consumption itself. Accordingly, the calculation formula is as below.

- $W_{pw} = 3/7 \{ (I_{5V} \times 5) + (I_{24V} \times 24) \}$  (W)

$I_{5V}$ : Current consumption of DC5V circuit of each module (internal current consumption)

$I_{24V}$ : Average current consumption of DC24V of output module (current consumption of simultaneous On point)

Not available in case that DC24V is supplied from outside or power module without DC24V output is used.

#### (2) Sum of DC5V circuit current consumption

DC5V output circuit current of power module is the sum of current consumption of each module.

- $W_{5V} = I_{5V} \times 5$  (W)

#### (3) DC24V Average current consumption (current consumption of simultaneous On point)

DC24V output circuit average current of power module is the sum of current consumption of each module.

- $W_{24V} = I_{24V} \times 24$  (W)

#### (4) Average current consumption by output voltage drop of output module (current consumption of simultaneous On point)

- $W_{out} = I_{out} \times V_{drop} \times \text{output point} \times \text{simultaneous On rate}$  (W)

$I_{out}$ : output current (current in actual use) (A)

$V_{drop}$ : voltage drop of each output module (V)



(5) Input average current consumption of input module (current consumption of simultaneous On point)

- $W_{in} = I_{in} \times E \times \text{input point} \times \text{simultaneous On rate (W)}$   
     $I_{in}$ : Input current (actual value in case of AC) (A)  
     $E$ : Input voltage (voltage in actual use) (V)

(6) Current consumption of Special module power

- $W_s = I_{5V} \times 5 + I_{24V} \times 24 + I_{100V} \times 100 (W)$

As above, the value that added the current consumption calculated per each block is total current consumption of PLC system.

- $W = W_{PW} + W_{5V} + W_{24V} + W_{out} + W_{in} + W_s (W)$

Calculate the radiation amount according to this total current consumption (W) and review the temperature rising in control panel.

The calculation formula of temperature rising in control panel is shown as below.

$$T = W / UA [^{\circ}\text{C}]$$

W : Total current consumption of PLC system(the value obtained on the above)

A : Surface area in control panel [ $\text{m}^2$ ]

U : In case of making the temperature in control panel by fan etc. - - 6

In case that the air in control panel is not circulated- - - - - 4

## 11.1.2 Handling Precautions

Here describes the notices in handling from the opening of each module to installation.

- Do not fall or apply the deep impact.
- Do not remove PCB from the case. It may cause the failure.
- Cares should be taken so that foreign materials such as wiring fragments are not entered into the upper part of module. If entered, remove it.

### 1) Notices in Handling I/O Module

Here describes the notices for the cases of handling or installing I/O module.

#### (1) Recheck of I/O module specification

For input module, you must consider input voltage and for output module, if the voltage exceeding max. open/close capacity is applied, it may cause the failure, destroy or fire.

#### (2) Use cable

Cable shall be selected considering ambient temperature and allowable current and min. spec. of cable should be more than AWG22(0.3mm<sup>2</sup>).

#### (3) Environment

In case of wiring I/O module, if it is too close to the equipment with high heat or the wiring is directly touched to the oil for a long time, it may cause the short circuit or occur the breakage or abnormal operation.

#### (4) Polarity

For the module having the polarity in terminal block, it is required to check the polarity before applying the power.

#### (5) Wiring

- In case of wiring that I/O wiring is carried out with high voltage cable or power cable, it may occur the inductive disturbance which result in abnormal operation or failure.
- Do not allow the cables to pass in front of I/O operation indicator (LED). (It is not possible to distinguish I/O indicator correctly.)
- In case that the inductive load is connected to output module, connect the surge absorber or diode to the load in parallel. The cathode of diode shall be connected to (+)pole of power.

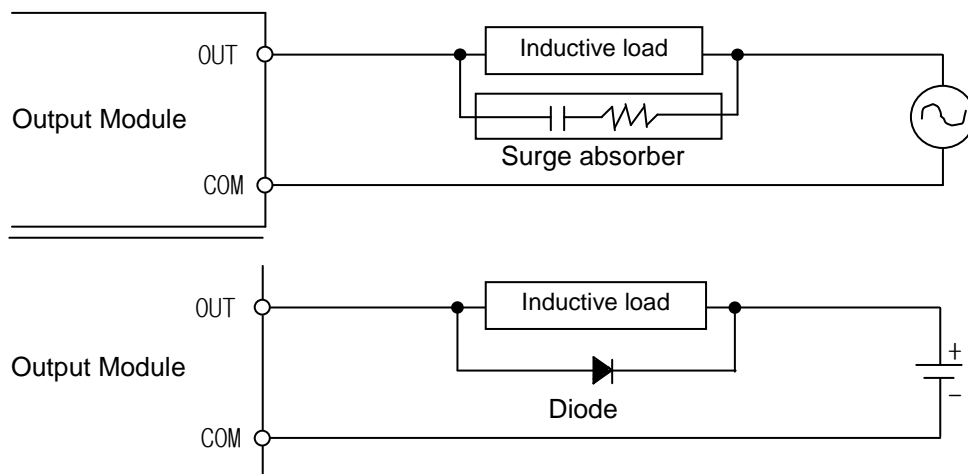

(6) Terminal Block

Check the compression state of terminal block and pay attention not to enter the fragments of cable into PLC in case of wiring of terminal block or processing the screw hole. If not, it may cause the abnormal operation or the failure.

(7) Except the examples above, do not apply deep impact to I/O module or remove PCB board from the case.

### 2) Notices in Attaching Base

Here describes the notices in case of attaching PLC to the control panel.

(1) Keep the distance enough between the upper part of module and the structures or parts in order to make a ventilation good and change the module easily.

(2) Avoid the longitudinal connection or horizontal attachment considering a ventilation.

(3) Use the panel different from the vibration sources of large sized electronic contactor or no fuse breaker etc., or keep the clearance when installing.

(4) Install the wiring duct if necessary. But cares should be taken for the following notices in case the dimension of the upper or lower part of PLC is smaller than that of Figure 11.1.

- In case of installing on the upper part of PLC, keep the height of wiring duct less than 50mm for good ventilation. And keep the distance from the upper part of PLC enough to press the hook on the upper part of Base.
- In case of installing on the lower part of PLC, consider the connection of optical cable or coaxial cable and minimum radius of cables.

(5) PLC should be installed to the direction as shown on the following Figure for good ventilation against radiation.

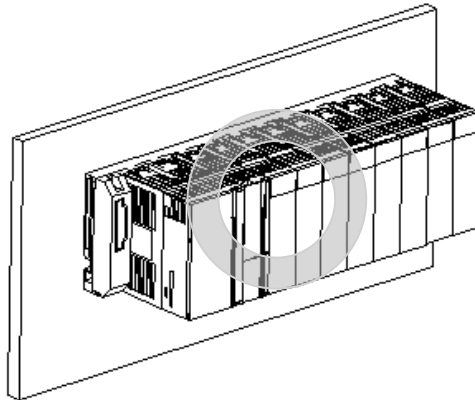

## Chapter 11 Installation and Wiring

(6) Do not install PLC to the direction as below.

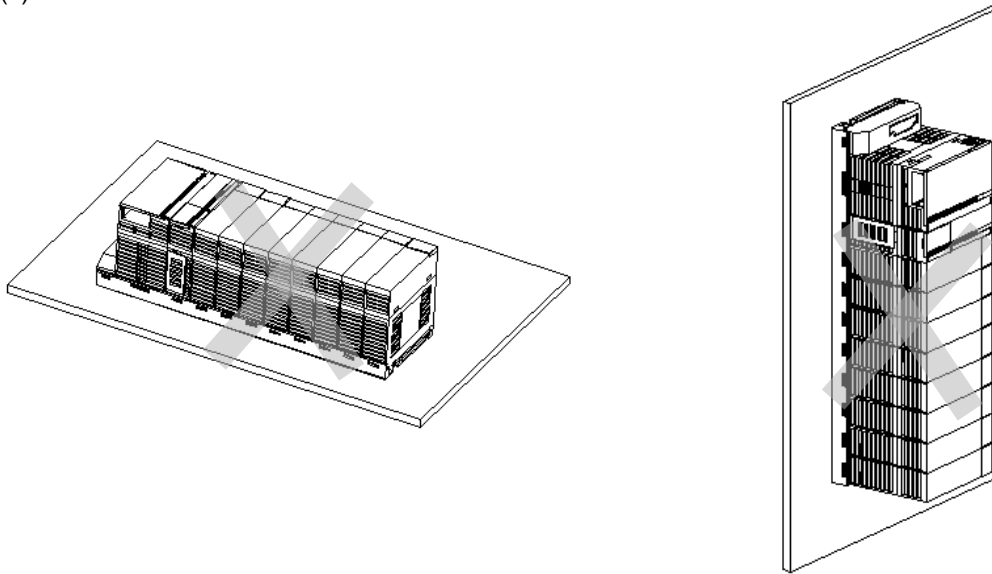

(7) When installing PLC or other equipment (Relay, electronic contactor), keep the distance to avoid radiant noise or heat.

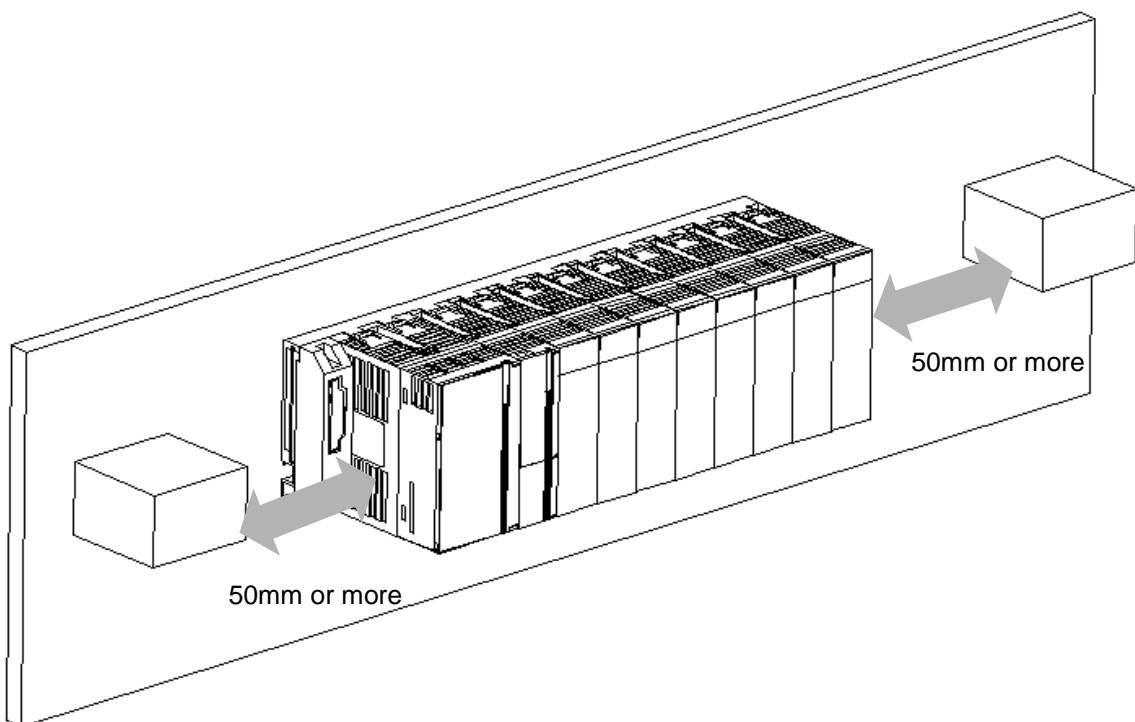
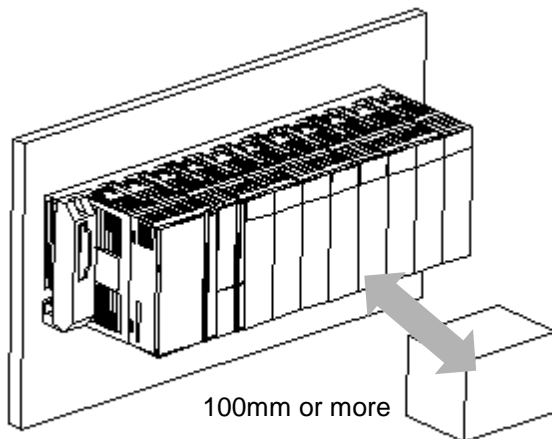

### 11.1.3 Attachment/Detachment of Module

Here describes the method to attach each module to the base or remove it.

#### 1) Attachment of Module

- Insert a fixed projection of the lower part of PLC into the module fixed hole of the base.
- Slide the upper part of module to fix to the base, and then fit it to the base by using the module fixed screw.
- Pull the upper part of module to check if it is installed to the base completely.

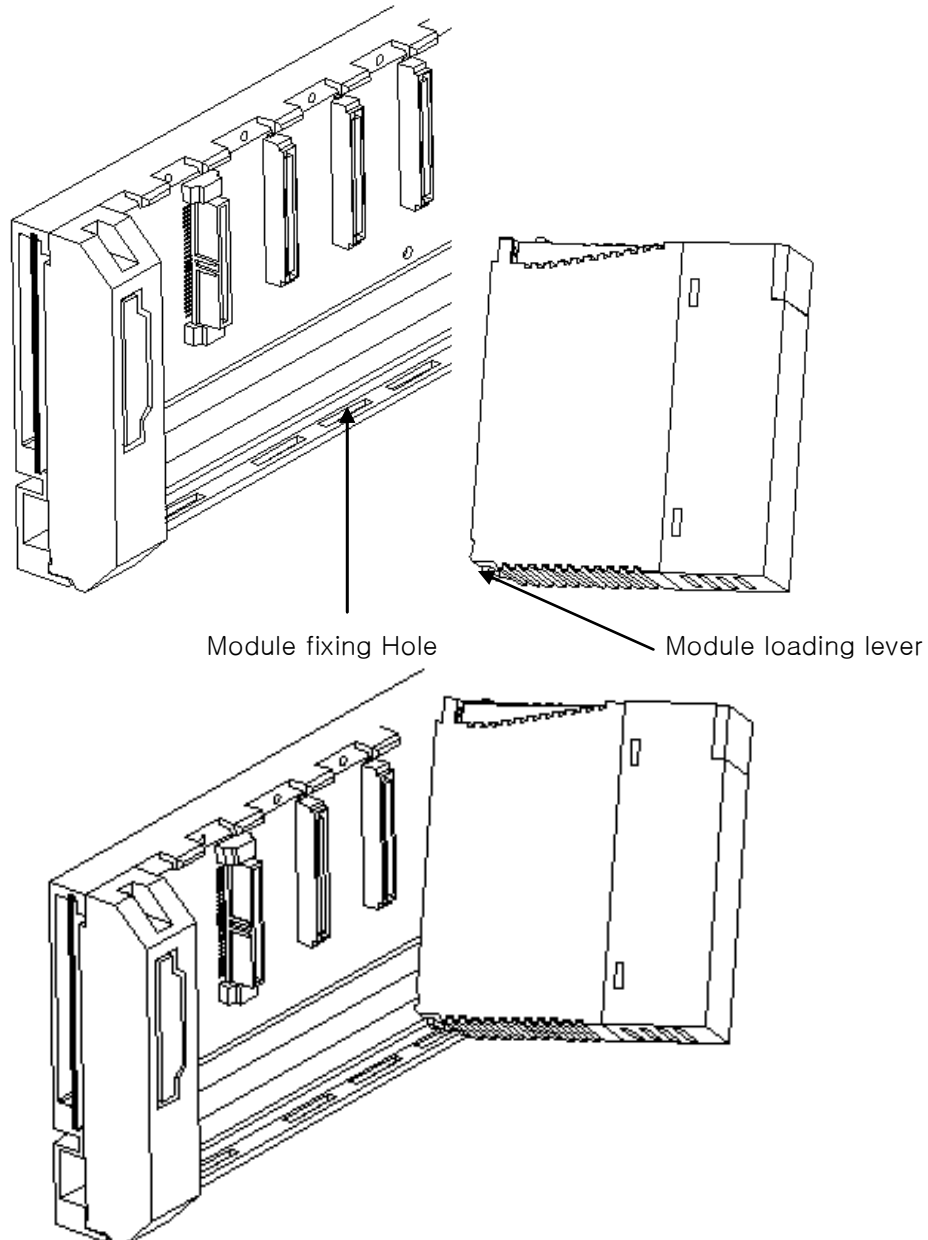

#### Notes

- 1) For Module installation, it is required to insert the fixed projection of module into the module fixing hole and then fix it. If forced to attach it, module may be broken.

### 2) Detachment of Module

- Loosen the fixed screws of the upper part of module from the base.
- Hold the module by both hands and press the fixed hook of module thoroughly.
- By pressing the hook, pull the upper part of module from the axis of the lower part of module.
- By lifting the module upward, remove the fixed projection of module from the fixing hole.

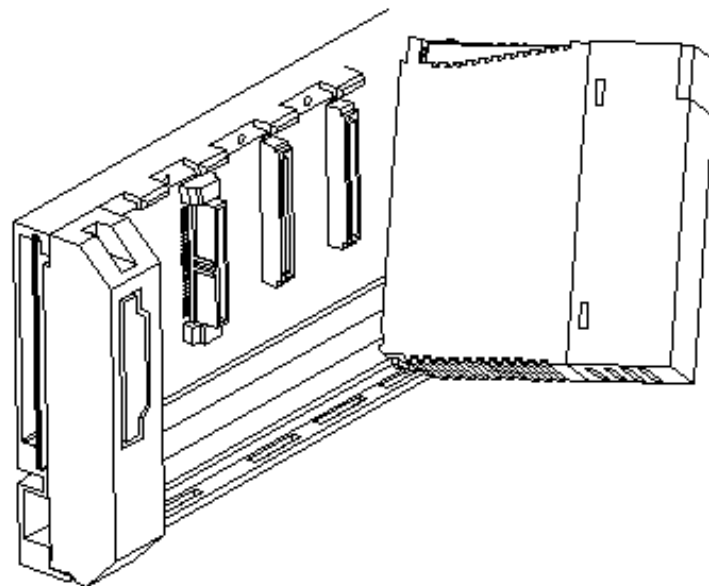
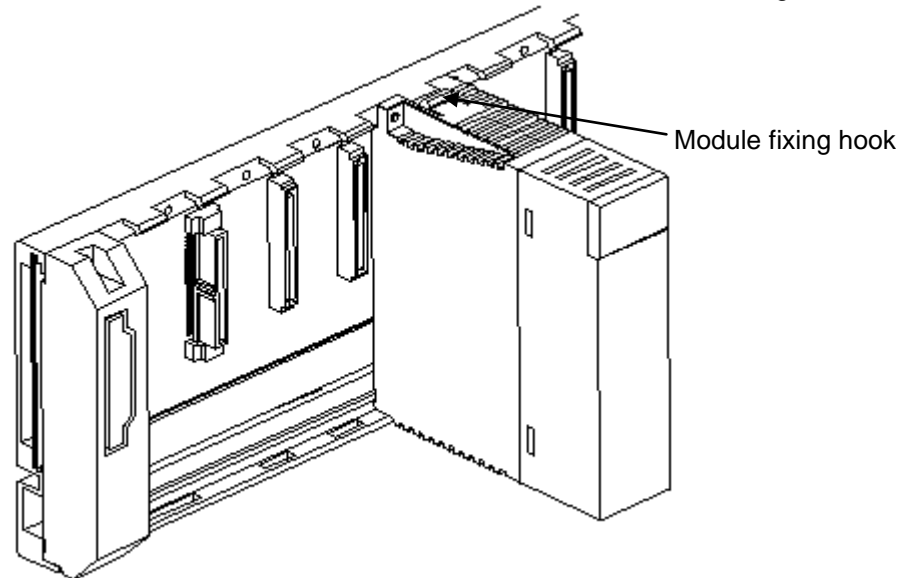

#### Notes

- 1) In case of detachment of module, press the hook and remove the module from the base, and then remove the fixed project of module from the fixed hole of module. In this case, if forced to detach the module, a hook or the fixed projection of module may be broken.

## 11.2 Wiring

Here describes the items to know related to the wiring, in case of using the system.

### 11.2.1 Power Wiring

- 1) In case that the power change is larger than the range of standard, connect the voltage regulated transformer.

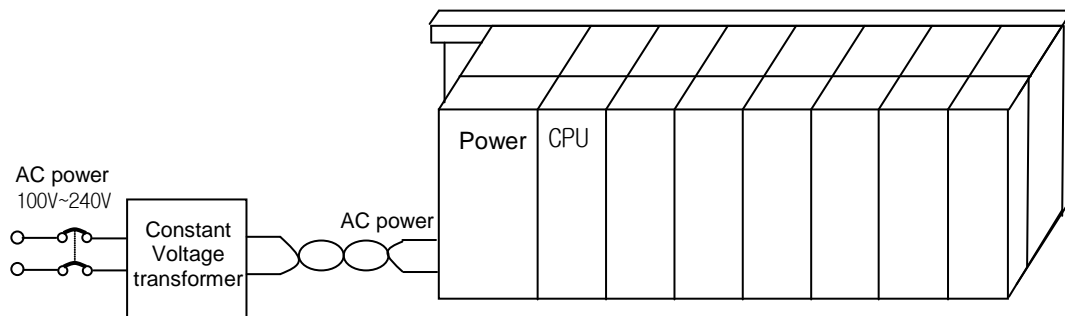

- 2) Connect the power having the small noise between cables or between earths.  
(In case of having lots of noise, connect the insulation transformer.)

- 3) For PLC power, I/O machine and power machine, divide the system as below.

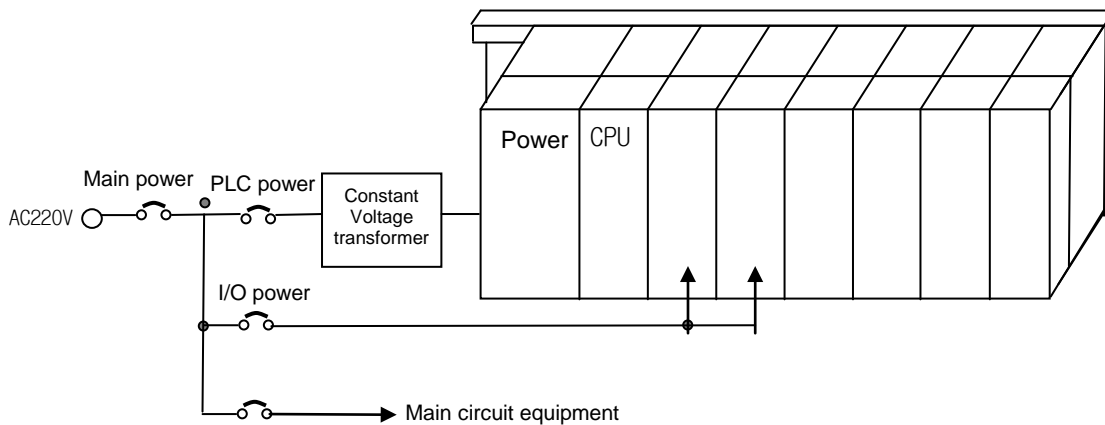

## Chapter 11 Installation and Wiring

4) In case of using a DC24V output of Power Module

- Do not connect a DC24V output of several power module in parallel. If connected in parallel, the module may be broken.
- In case that DC24V output capacity of one power module is not enough, supply the external DC24V power as below.

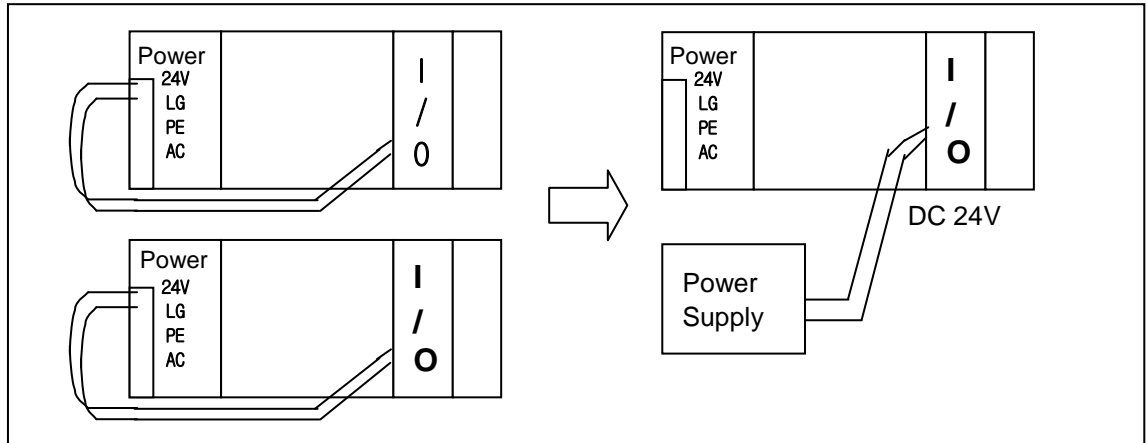

5) AC110V, AC220V, DC24V cables should be twisted tightly and connected within the shortest distance.

6) AC110V, AC220V cables use the thick cable (2mm<sup>2</sup>) to reduce the voltage drop.

AC110V, DC24V cables should not approach to main circuit (high voltage, high current) cable or I/O signal cable. Keep more than 100mm if possible.

7) Use the surge absorber against lightning as shown in the figure below.

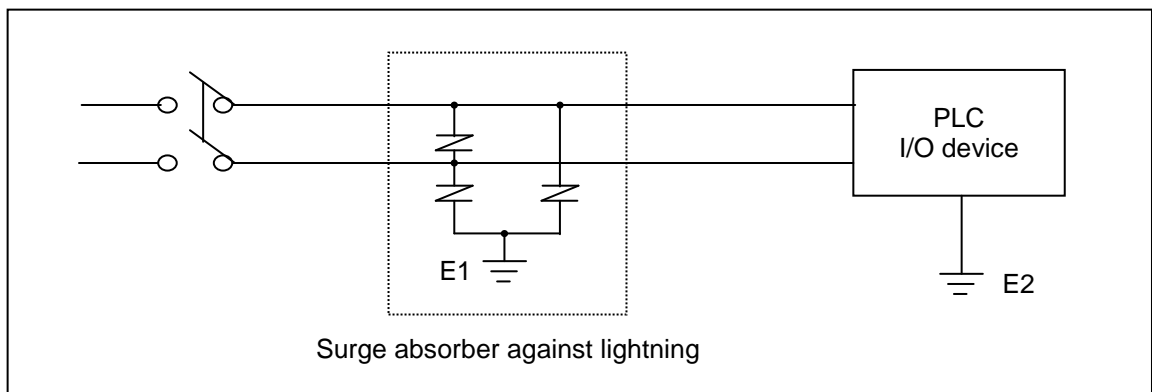

### Notes

- 1) Separate PLC earth(E2) from the earth(E1) of surge absorber against lightning.
- 2) Select the surge absorber against lightning not to exceed max. allowable voltage of surge absorber in case of rising the power voltage at max.

8) Use the shielded insulation trans or noise filter when a noise invasion is expected.

9) The wiring of each input power should be twisted shortly if possible, and the shielded trans or noise filter wiring should be done without passing the duct.



## Chapter 11 Installation and Wiring

### 11.2.2 I/O Device Wiring

- 1) The spec. of cable for I/O wiring shall be  $0.3\sim 2\text{ mm}^2$  but it is recommend to use the convenient cable spec. ( $0.3\text{ mm}^2$ ).
- 2) Separate Input cable and Output cable for wiring.
- 3) I/O signal cable should be separated more than 100mm from main circuit cable of high voltage/high current.
- 4) If not possible to separate main circuit cable and power cable, use the shielded cable all and earth a PLC.

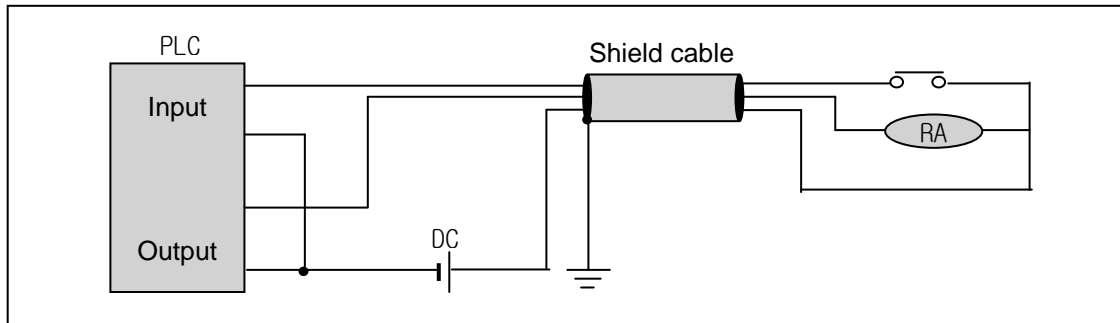

- 5) In case of pipe wiring, check the pipe completely for earth.
- 6) Separate output cable of DC24V from AC110V cable or AC220V cable.

For the long distance wiring more than 200m, as it is expected to have problem by leakage current caused by the capacity between cables, please refer to 12.4 Various Cases.

### 11.2.3 Earth Wiring

- 1) As this PLC has a sufficient measures against noise, it is possible to use it without earth except the case having specially lots of noises.
- 2) Use the dedicated earth if possible.  
In case of Earth works, use 3 class earth (earth resistance  $100\ \Omega$  or less).
- 3) If not possible to use dedicated earth, use the common earth as shown on the Figure B] as below.

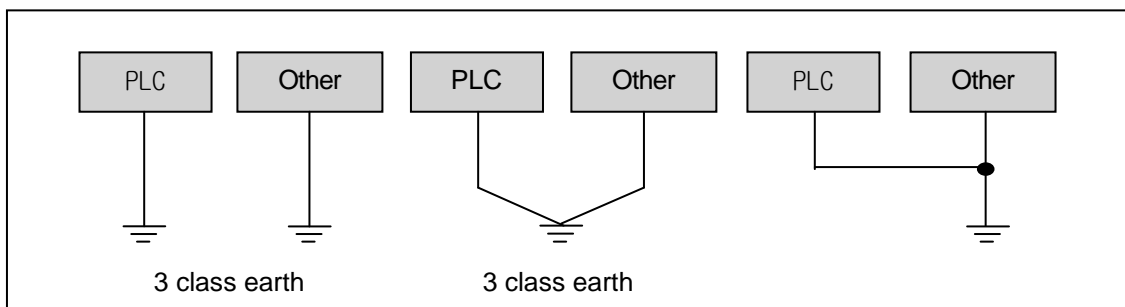

A) Dedicated earth : Best

B) Common earth : Good

C) Common earth : Poor

## Chapter 11 Installation and Wiring

- 4) Use more than 2 mm<sup>2</sup> cable for earth. Place the earth point near this PLC as possible to have the short length of earth cable.
- 5) Separate LG of power module and PE of base board for earth.

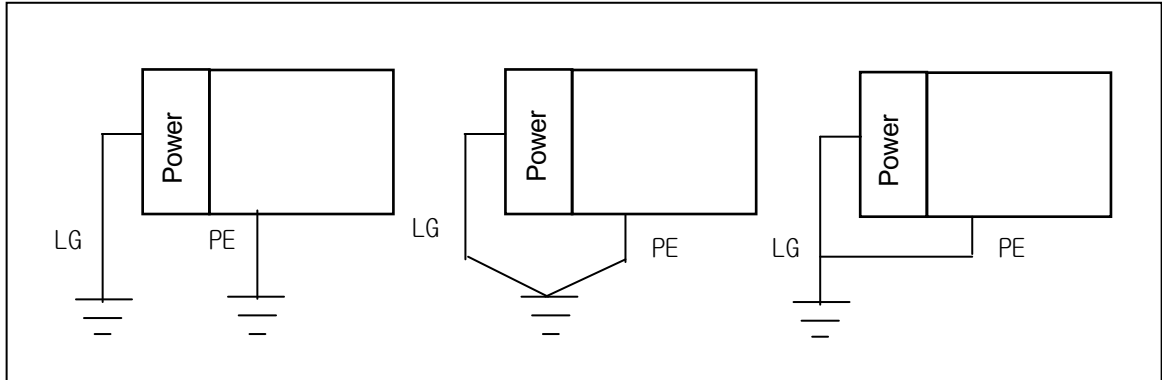

A) dedicated earth : Best

B) common earth : Good

C) common earth: Poor

- 6) If the abnormal operation is found according to the earth, separate PE of the base from the earth.

### 11.2.4 Cable Specification for Wiring

The specification of cable used for wiring is as below.

Type of External Connection	Cable specification (mm <sup>2</sup> )	
	Low limit	High limit
Digital Input	0.18 (AWG24)	1.5 (AWG16)
Digital Output	0.18 (AWG24)	2.0 (AWG14)
Analog I/O	0.18 (AWG24)	1.5 (AWG16)
Communication	0.18 (AWG24)	1.5 (AWG16)
Main power	1.5 (AWG16)	2.5 (AWG12)
Protection earth	1.5 (AWG16)	2.5 (AWG12)

## Chapter 12 Maintenance and Repair

Please carry out Daily Checking and Regular Checking to maintain PLC in best condition.

### 12.1 Repair and Checking

As I/O module is mainly consisted of semiconductor elements, the life seems to be semi-permanent. But the error in the elements may occur by surrounding environment and thus the regular checking is needed. For the items to check 1~2 times every 6 months, please refer to the following table.

Checking items		Judgment basis	Actions
Power Supply		Power change range (within -15% / +10% )	Change the power so that it should be within the allowable voltage range.
I/O power		I/O specifications of each module	Change the power so that it should be within the allowable voltage range of each module
Surrounding environment	Temperature	0 ~ + 55°C	Adjust the ambient temperature and humidity to be in proper range.
	Humidity	5 ~ 95%RH	
	Vibration	No vibration	Use the vibration-proof rubber or take other measures to prevent the vibration.
Shaking of each module		No shaking	All module should not be shaken.
Loosening of terminal screw		No loosening	Tighten the loosened screw.
Spare parts		The possessing amount and preservation state	Fill the lack and improve the preservation state

### 12.2 Daily Checking

The items to check daily are as follows.

Checking items		Contents	Judgment Basis	Action
Base attachment state		Check the loosening of attached screw.	Complete tightening	Tighten screw
I/O module attachment state		<ul style="list-style-type: none"> <li>• Check if the attached screw of module is tightened completely.</li> <li>• Check if the upper cover of module is removed.</li> </ul>	Complete tightening	Check screw
Connection state of terminal block and extended cable		Loosening of terminal screw	No loosening	Tighten screw
		Approach between compressed terminal	Proper interval	Adjust
		Connector of extended cable	No connector loosening	Adjust
Indicator LED	Power LED	Check LED ON	LED ON (off is abnormal)	Ref. Cha.13
	RUN LED	Check LED ON during Run state	LED ON (off or blink is abnormal)	Ref. Cha.13
	STOP LED	Check LED OFF during Run state	Blink is abnormal.	Ref. Cha.13
	Input LED	Check LED ON/OFF	Input On, LED ON Input Off, LED OFF	Ref. Cha.13
	Output LED	Check LED ON/OFF	Output On, LED ON Output Off, LED OFF	Ref. Cha.13

## Chapter 12 Maintenance and Repair

### 12.3 Regular Checking

Check the following items 1~2 times every 6 months and take a necessary actions.

Checking items		Contents	Judgment Basis	Action
Surrounding environment	Temperature	Thermometer/humidifier corrosive gas measurement	0 ~ 55 °C	Adjust to meet general specification (environment standard in control panel)
	Humidity		5 ~ 95%RH	
	Pollution degree		No corrosive gas	
PLC state	loosening, shaking	Move each module	Complete tightening	Tighten screw
	Dust, foreign materials	Macrography	No attachment	-
Connection state	Screw loosening	Tighten by driver	No loosening	Tighten
	Approach of compressed terminal	Macrography	Proper interval	Adjust
	Connector loosening	Macrography	No loosening	Tighten connector screw
Power voltage checking		Check the power voltage of the power input terminal using a tester.	AC100~240V: AC85~ 264V DC24V:DC19.2 ~ 28.8V	Change the power supply
Battery		Check the battery change period and voltage drop indication.	<ul style="list-style-type: none"> <li>• Check total shutdown time and warranty</li> <li>• No indication of battery voltage drop</li> </ul>	Change the battery if exceeding the warranty without battery capacity indication
Fuse		Macrography	<ul style="list-style-type: none"> <li>• No cutoff</li> </ul>	Change it regularly as deterioration of element may occur by inrush current.

## Chapter 13 EMC Directive

### 13.1 Requirements for Conformance to EMC Directive

The EMC Directive specifies the products must “be so constructed that they do not cause excessive electromagnetic interference (emissions) and are not unduly affected by electromagnetic interference (immunity)”. The applicable products are requested to meet these requirements.

This section summarizes the precautions on conformance to the EMC Directive of the machinery assembled using PLC XGK series. The details of these precautions are based on the requirements and the applicable standards control. However, LSIS will not guarantee that the overall machinery manufactured according to the these details conforms to the below-described directives. The method of conformance to the EMC directive and the judgment on whether or not the machinery conforms to the EMC Directive must be determined finally by the manufacturer of the machinery.

#### 13.1.1 EMC Standard

The standards applicable to the EMC Directive are listed below.

Table13-1

Specification	Test item	Test details	Standard value
EN50081-2	EN55011 Radiated noise * 2	Electromagnetic emissions from the product are measured	30~230 MHz QP : 50 dB $\mu$ V/m * 1 230~1000 MHz QP : 57 dB $\mu$ V/m
	EN55011 Conducted noise	Electromagnetic emissions from the product to the power line is measured	150~500 kHz QP : 79 dB Mean: 66 dB 500~230 MHz QP : 73 dB Mean: 60 dB
EN61131-2	EN61000-4-2 Electrostatic immunity	Immunity test in which static electricity is applied to the case of the equipment	15 kV Aerial discharge 8 kV Contact discharge
	EN61000-4-4 Fast transient burst noise	Immunity test in which burst noise is applied to the power line and signal lines	Power line: 2 kV Digital I/O : 1 kV Analog I/O, signal lines: 1 kV
	EN61000-4-3 Radiated field AM modulation	Immunity test in which field is irradiated to the product	10Vm,26~1000 MHz 80%AM modulation @ 1 kHz
	EN61000-4-12 Damped oscillatory wave immunity	Immunity test in which a damped oscillatory wave is superimposed on the power line	Power line: 1 kV Digital I/O (24V or higher): 1 kV

\* 1) QP: Quasi-peak value, Mean: Average value

\* 2) The PLC is an open type device (device installed to another device) and must be installed in a conductive control panel. The tests for the corresponding items were performed while the PLC was installed inside a control panel.

### 13.1.2 Control Panel

The PLC is an open type device (device installed to another device) and must be installed in a control panel. This is needed to prevent electric shock by touching XGK PLC and reduce the PLC-generated noise. Install the XGK PLC in a metallic panel to reduce PLC-generated EMI (Electro-magnetic interference), The specifications for the control panel are as follows:

#### 1) Control panel

The PLC control panel must have the following features:

- (1) Use SPCC (Cold Rolled Mild Steel) for the control panel.
- (2) The steel plate should be thicker than 1.6mm.
- (3) Use isolating transformers to protect the power supply from external surge voltage.
- (4) The control panel must have a structure which the radio waves does not leak out.

For example, make the door as a box-structure so that the panel body and the door are overlapped each other. This structure reduces the surge voltage generate by PLC.

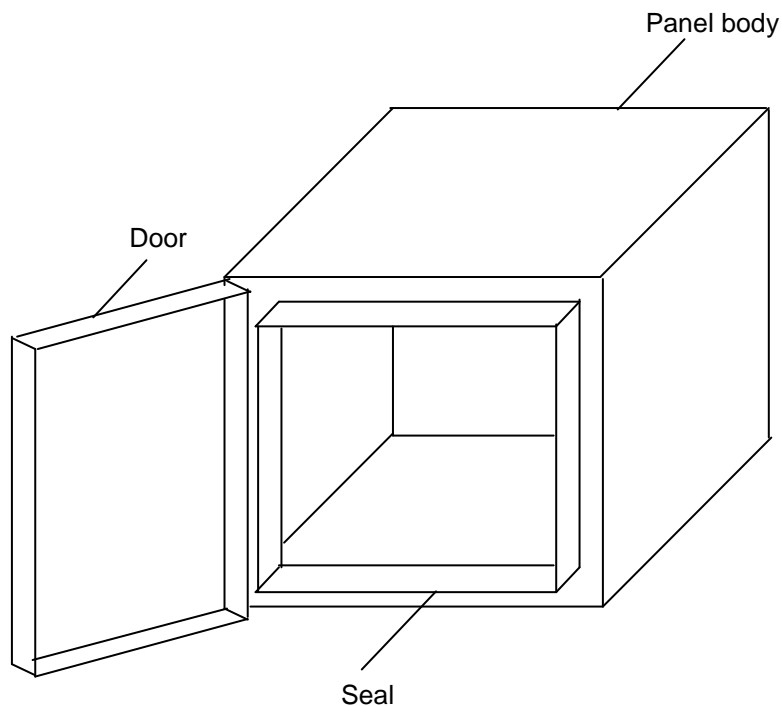

- (5) To ensure good electrical contact with the control panel or base plate, mask painting and weld so that good surface contact can be made between the panel and plate.

2) Connection of power and earth wires

Earthing and power supply wires for the PLC system must be connected as described below.

- (1) Earth the control panel with a thick wire so that a low impedance connection to ground can be ensured even at high frequencies.
- (2) The function of LG (Line Ground) and PE (Protective Earth) terminals is to pass the noise generated in the PLC system to the ground, so an impedance that is as low as possible must be ensured.
- (3) The earthing wire itself can generate the noise, so wire as short and thick to prevent from acting as an antenna.

**13.1.3 Cables**

1) Extension cable connection

The extension cables contain a high frequency noise. Therefore, a ferrite core is attached to the extension cable as shown in the picture below to meet the CE conformance.

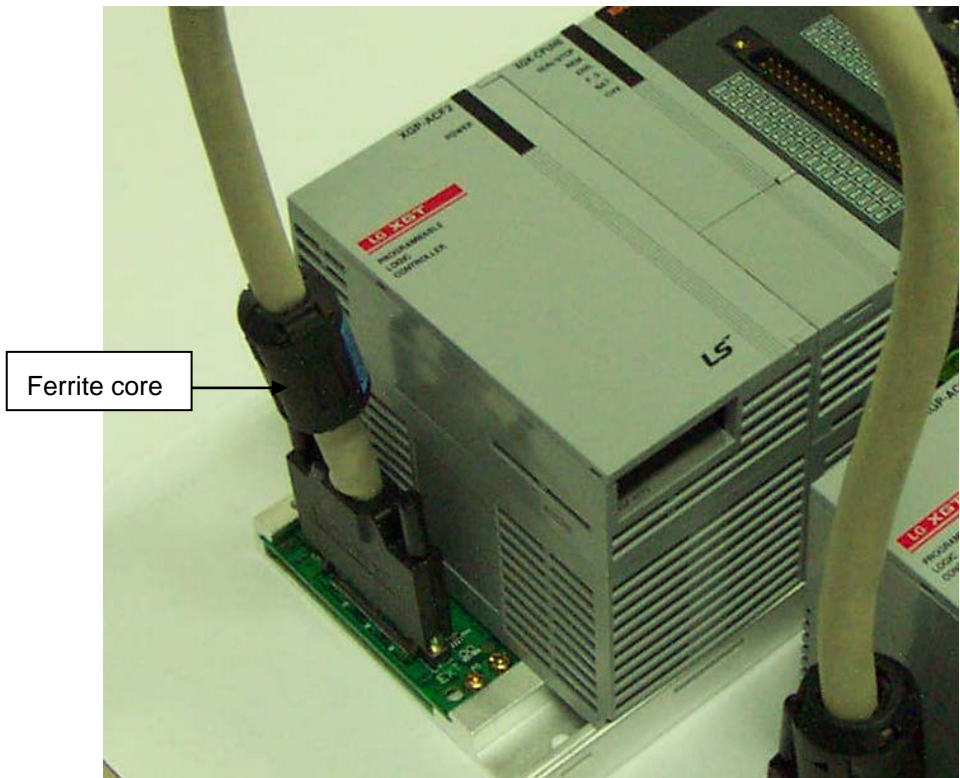

Model	Manufacturer	Remarks
CU1330D	E-TECH ELECTRONICS	-
ZCAT3035-1330	TDK	-

2) Cable connection method for the inside control panel

In the case that the extension cable is connected to the metal panel, a space of at least 1cm is needed from the panel. The metal board of the control panel has a shielding effect that blocks noise, but it could be served as an antenna when in contact with a cable which would create a noise source.

Keep all high-speed signal transmission cables at a safe distance from the metal board.

### 13.2 Requirement to Conform to the Low-voltage Directive

The low-voltage directive requires each device that operates with the power supply ranging from 50V to 1000VAC and 75V to 1500VDC to satisfy the safety requirements. Cautions and installation and wiring of the PLC XGK series to conform to the low-voltage directive are described in this section.

The described contents in this manual are based on the requirements and the applicable standards control. However, LSIS will not guarantee that the overall machinery manufactured according to these details conforms to the above regulation. The method of conformance to the EMC directive and the judgment on whether or not the machinery conforms to the EMC Directive must be determined finally by the manufacturer of the machinery.

#### 13.2.1 Standard Applied for XGK Series

The XGK series follow EN6100-1 (safety of devices used in measurement rooms, control rooms, or laboratories). And the XGK series modules which operate at the rated voltage of AC50V/DC75V or above are also developed to conform the above standard.

#### 13.2.2 XGK Series PLC Selection

(1) Power module

There are dangerous voltages (voltages higher than 42.4V peak) inside the power supply modules of the AC110/220V rated I/O voltages. Therefore, the CE mark-compliant models are enhanced in insulation internally between the primary and secondary.

(2) I/O module

There are dangerous voltages (voltages higher than 42.4V peak) inside the I/O modules of the AC110/220V rated I/O voltages. Therefore, the CE mark-compliant models are enhanced in insulation internally between the primary and secondary.

The I/O modules of DC24V or less rating are out of the low-voltage directive application range.

(3) CPU module, Base unit

The above modules are using DC5V and 3.3V circuits inside, so they are out of the low-voltage directive application range.

(4) Special module, Communication module

The special module and communication modules are DC24V or less in rated voltage, therefore they are out of the low-voltage directive application range.



## Chapter 14 Troubleshooting

Here describes the contents of various errors to be occurred while operating the system, the methods to find the causes and the actions.

### 14.1 Basic Procedure for Troubleshooting

It is important to use the high reliable machine to increase the system reliability but it is important to take a prompt action when the trouble occurs as well.

To start the system promptly, it is more important to find the trouble occurring cause promptly and take the necessary action. The basic items to comply when taking this trouble shooting are as follows.

1) Check by the naked eye

Check the following items by the naked eye.

- Machine operation state (STOP, RUN)
- Power supply state
- I/O machine state
- Wiring state (I/O cable, extended and communication cable)
- After checking the indication state of each indicator (Power LED, Run LED, Stop LED, I/O LED etc.), connect the peripheral device and check PLC operation state and program contents.

2) Trouble Checking

Examine how the trouble is changed by the following action.

- Place the key switch on STOP position and apply the power ON/OFF.

3) Limit range

Estimate what is the trouble cause using the above method.

- Is it from PLC itself ? Or external cause ?
- Is it from I/O module ? Or other cause?
- Is it from PLC program?

### 14.2 Troubleshooting

Here describes the method to find the trouble, the error code and the actions on the above by dividing them per phenomenon.

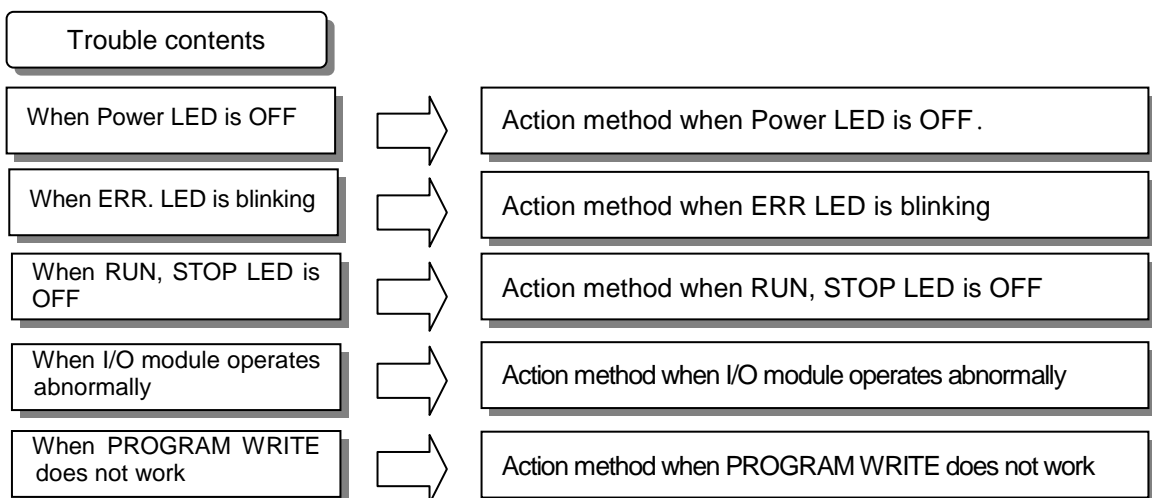

14.2.1 Action when Power LED is OFF

Here describes the action procedure when Power LED is OFF while supplying the power or during operation.

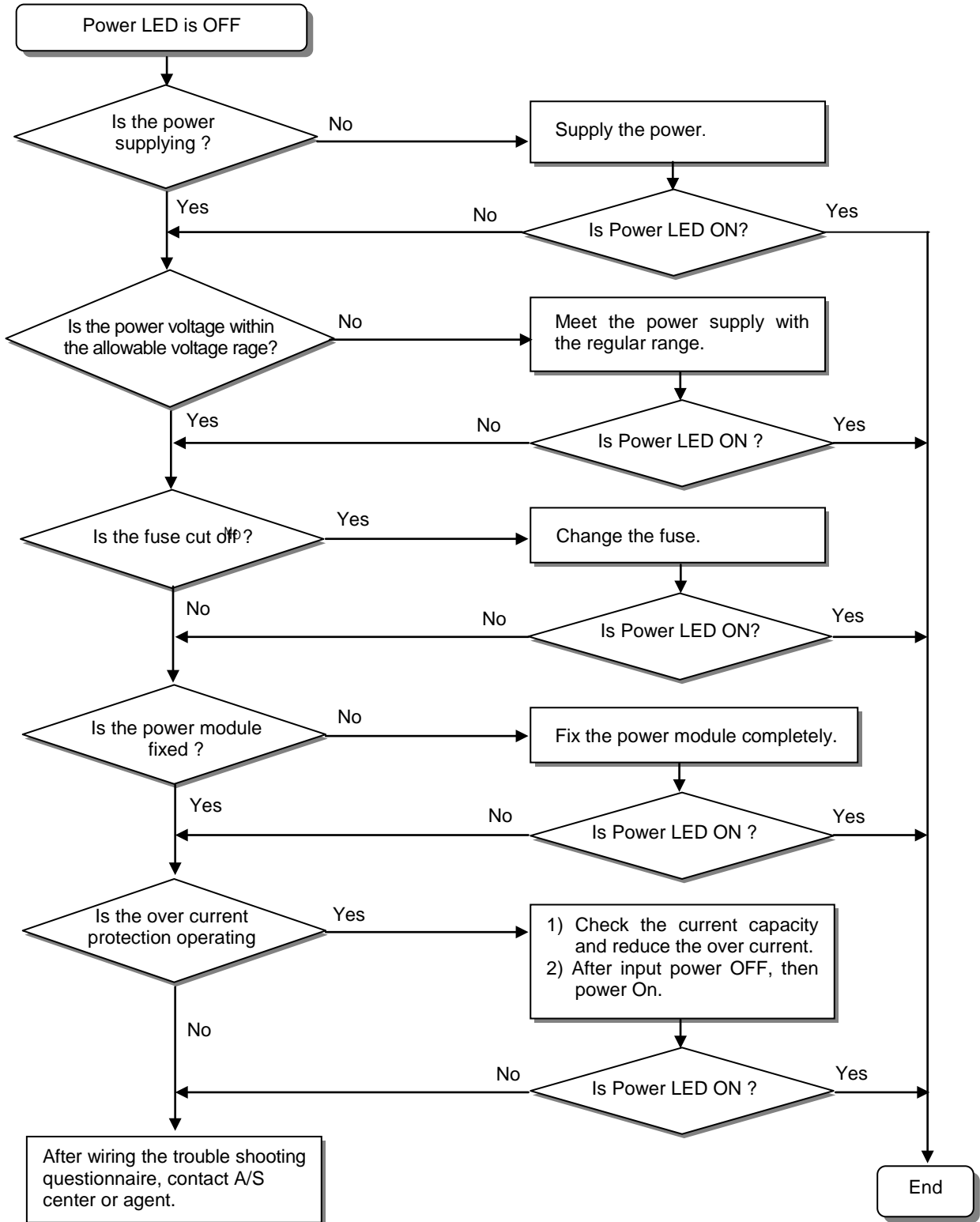

14.2.2 Action when ERR LED is blinking

Here describes the action procedure when ERROR LED is blinking in case of power supply, or when operation starts, or during operation.

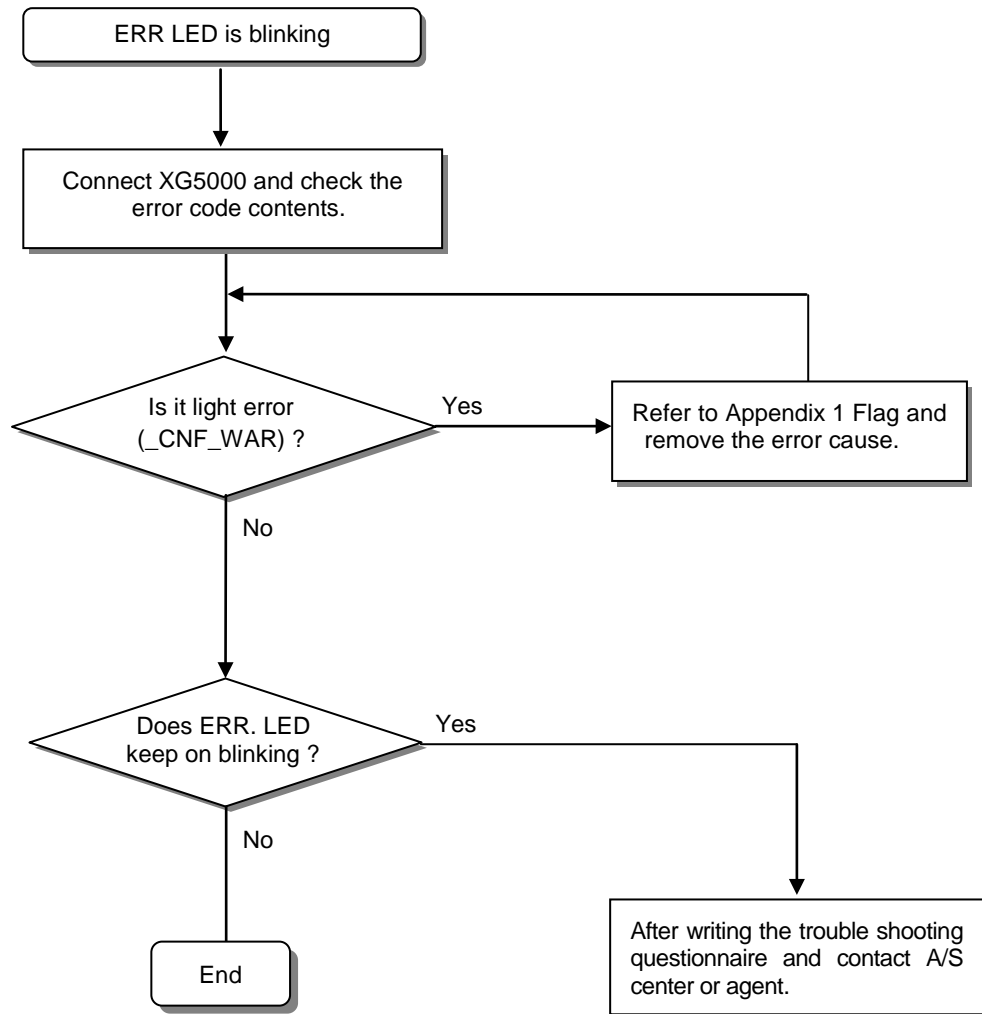

**Notes**

1) In case of light error, PLC system does not stop but you should check the error contents promptly and take an action. If not, it may cause the heavy error.

**14.2.3 Action when Run, Stop LED is OFF**

Here describes the action procedure when RUN, STOP LED is OFF in case of power supply, when operation starts or during operation.

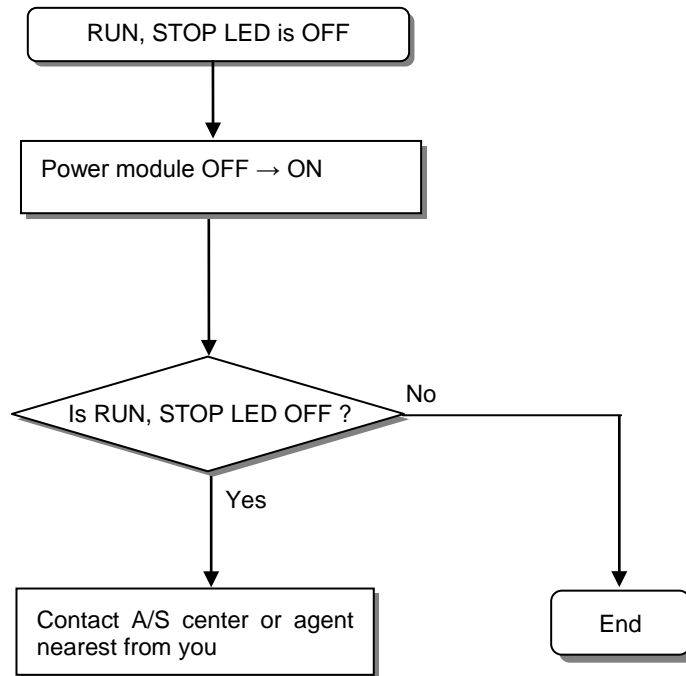

14.2.4 Action when I/O Module does not work normally

Here describes the action procedure when I/O Module does not work normally during operation, as shown on the program example below.

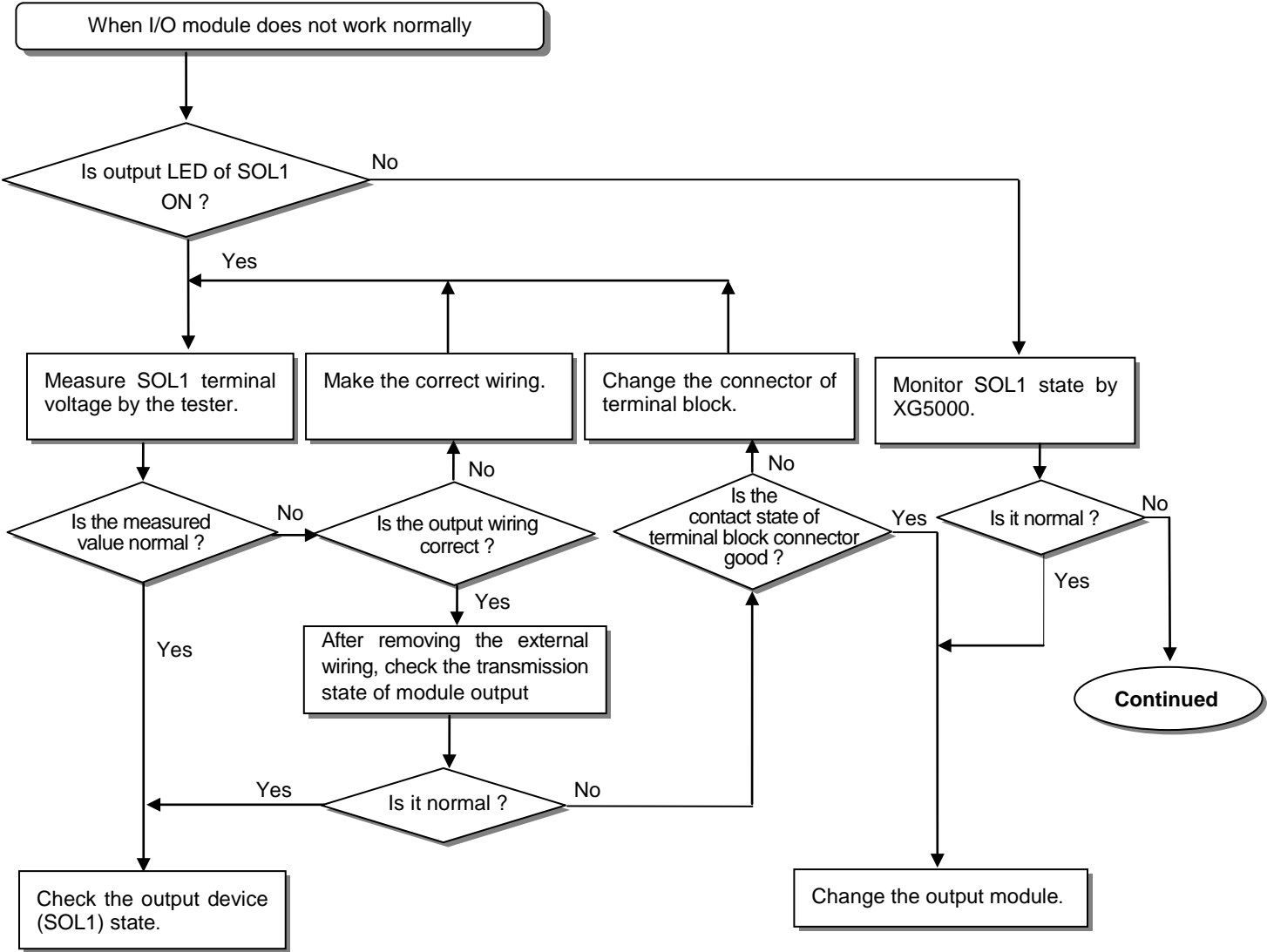
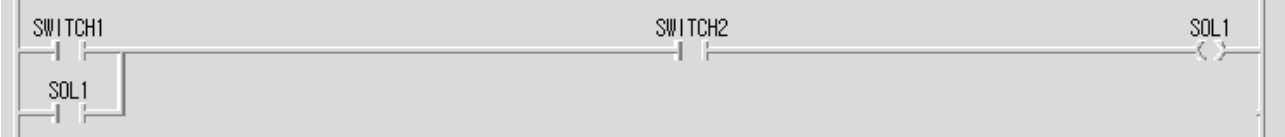

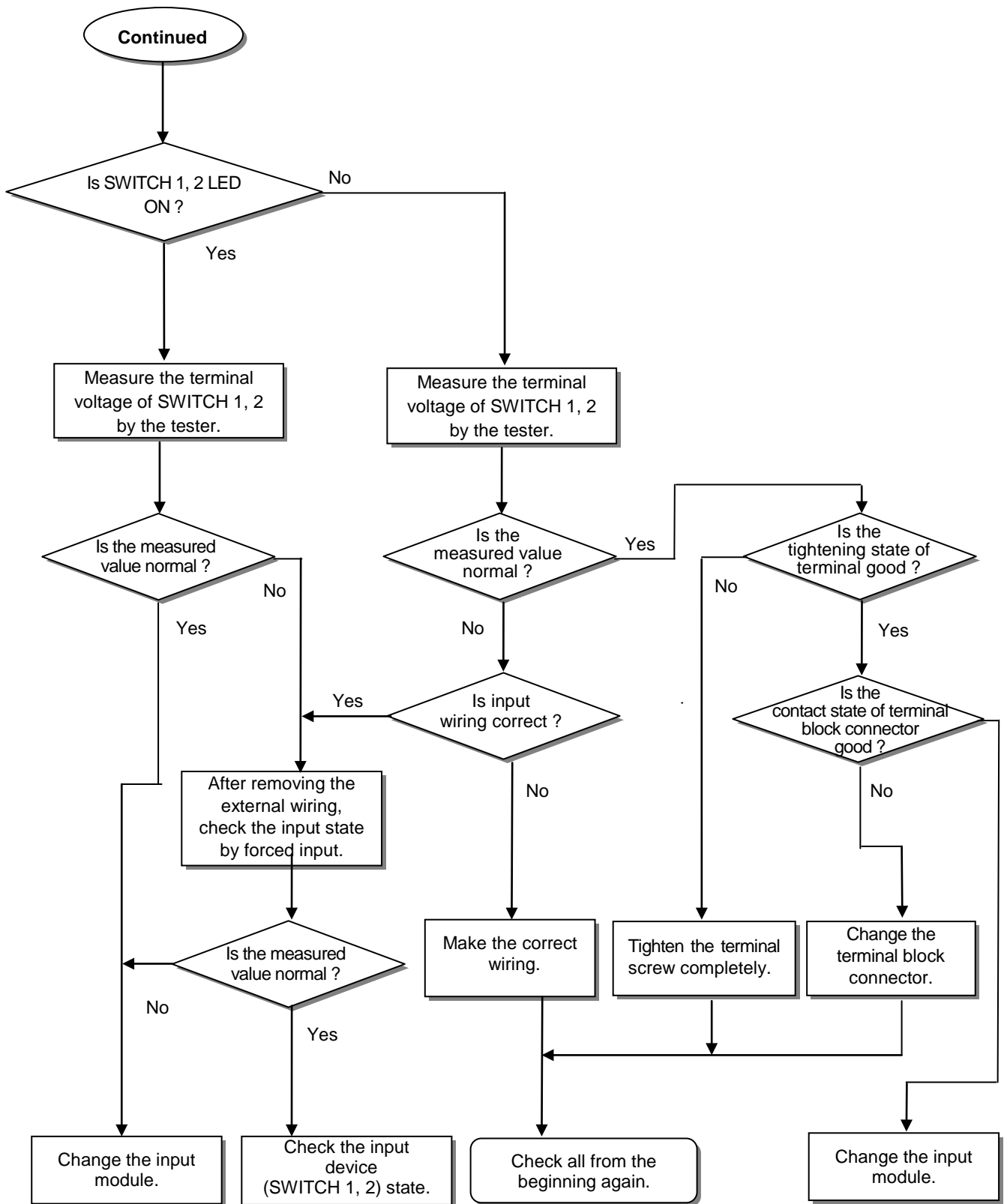

14.2.5 Action when PROGRAM WRITE does not work

Here describes the action procedure when PROGRAM WRITE does not work in CPU Module.

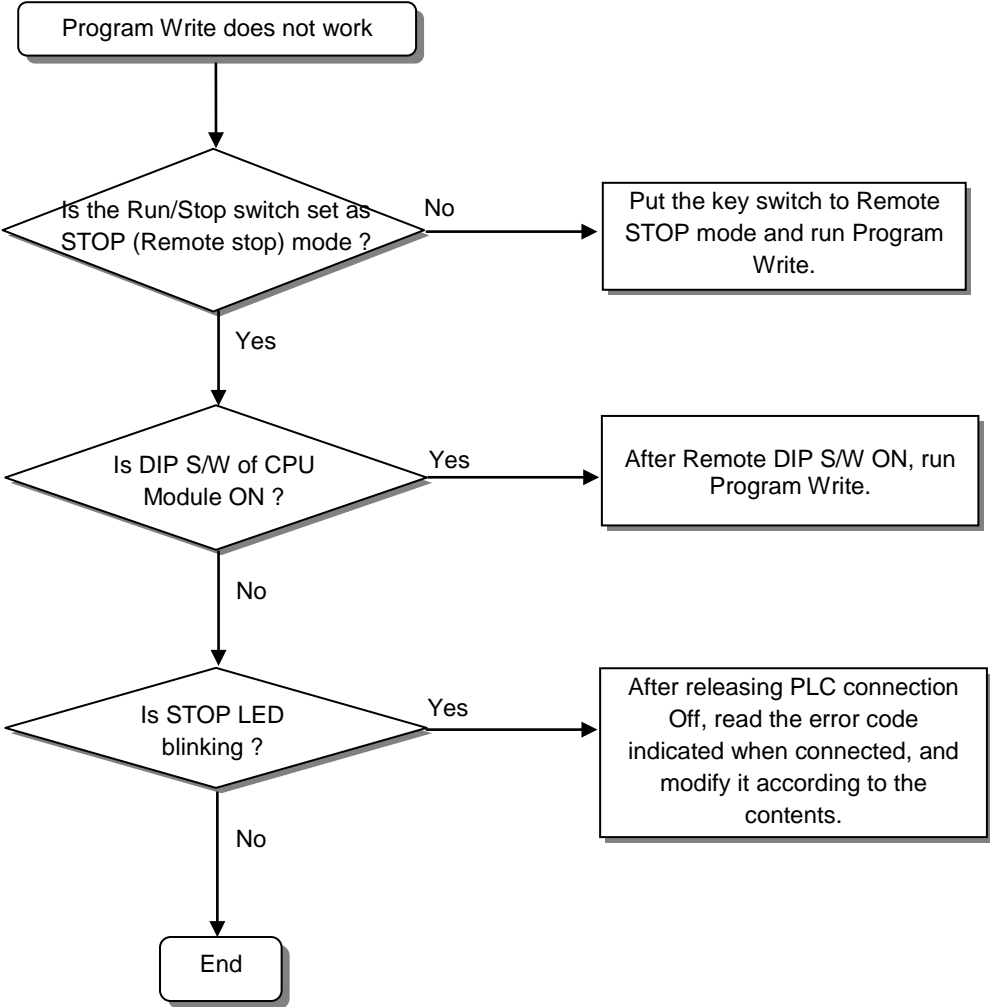





### 14.4 Cases

Here describes the trouble type and measures for each circuit.

#### 14.4.1 Input Circuit Error Type and Corrective Actions

Here describes the trouble examples of input circuit and its measures.

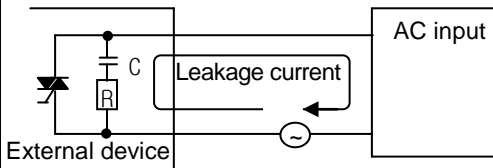
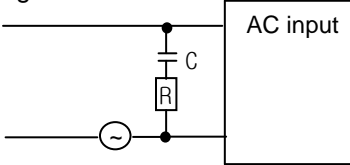
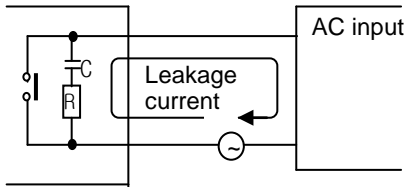
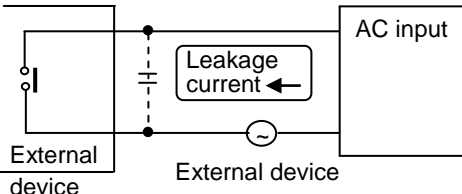
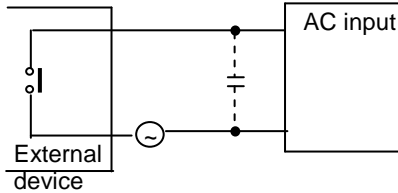
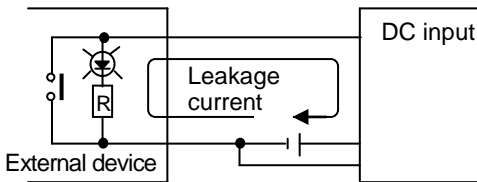
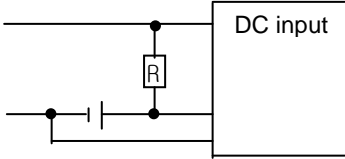
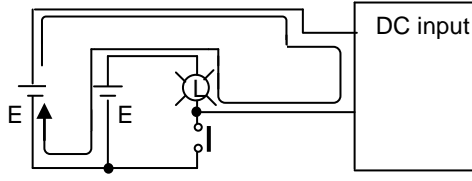
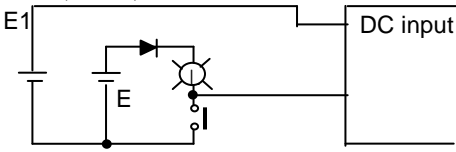
Phenomena	Causes	Measures
Input signal not OFF	<p>Leakage current of external device (In case of running by approach switch)</p> 	<ul style="list-style-type: none"> <li>Connect the proper resistance and capacity so that the voltage between terminals of input module is below return voltage.</li> </ul> 
Input signal not OFF (sometimes neon lamp ON)	<p>Leakage current of external device (run by limit switch with neon lamp)</p> 	<ul style="list-style-type: none"> <li>CR value is determined by leakage current.</li> <li>Recommended C : 0.1 ~ 0.47Uf</li> <li>R : 47 ~ 120 Ω (1/2W)</li> <li>or make the circuit independently and install a separate circuit.</li> </ul>
Input signal not OFF	<p>Leakage current by capacity between wiring cables</p> 	<ul style="list-style-type: none"> <li>Install the power on the external device as below.</li> </ul> 
Input signal not OFF	<p>Leakage current of external device (run by switch with LED indicator)</p> 	<ul style="list-style-type: none"> <li>Connect the proper resistance as below so that the voltage between input module terminal and common terminal exceeds OFF voltage.</li> </ul> 
Input signal not OFF	<ul style="list-style-type: none"> <li>Circulated current by double power</li> </ul>  <p>In case of E1 &gt; E2, circulated.</p>	<ul style="list-style-type: none"> <li>Double power --&gt; single power.</li> <li>Connect purified current prevent diode.</li> </ul> <p>(as below)</p> 

# Chapter 14 Troubleshooting

## 14.4.2 Output Circuit Error Types and Corrective Actions

Here describes the trouble examples of output circuit and its measures.

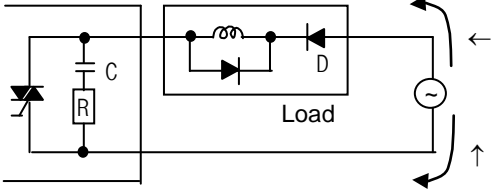
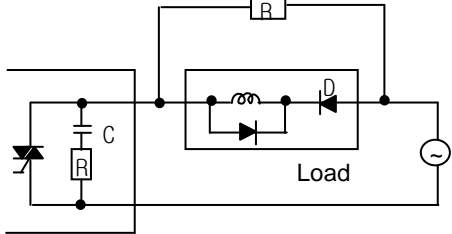
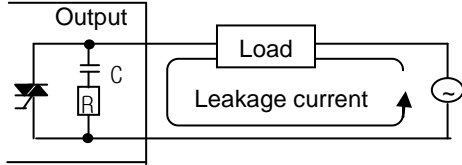
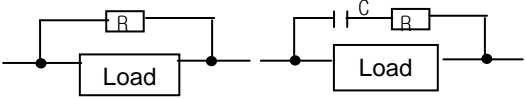
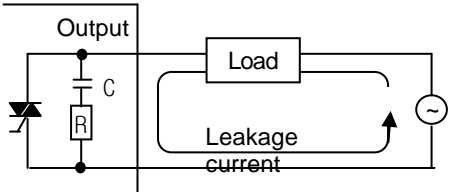
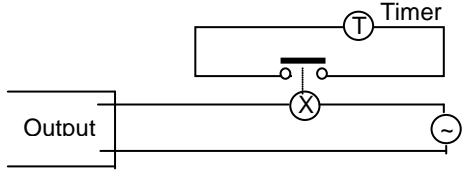
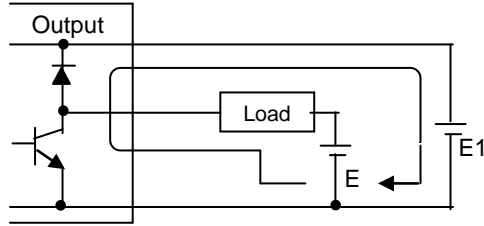
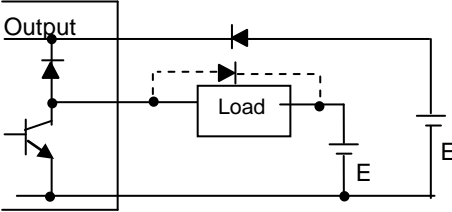
Phenomena	Causes	Measures
<p>Over voltage applied to the load if case of output contact OFF</p>	<ul style="list-style-type: none"> <li>In case that the load is semi-sine inside, (solenoid valve)</li> <li>If power polarity is <math>\leftarrow</math>, C is charged, if polarity is <math>\uparrow</math>, voltage charged to C +power voltage is applied to both sides of diode(D).</li> </ul> <p>Max. voltage is about <math>2\sqrt{2}</math>.</p>  <p>Note) If used as above, output element does not make trouble but the function of diode(D) built-in the load becomes low which causes the trouble.</p>	<ul style="list-style-type: none"> <li>Connect several dozens <math>k\Omega</math> ~ hundreds <math>k\Omega</math> resistance to the load in parallel.</li> </ul> 
<p>The load is not OFF</p>	<ul style="list-style-type: none"> <li>Leakage current by surge absorption circuit connected with output element in parallel</li> </ul> 	<ul style="list-style-type: none"> <li>Connect CR with several dozens <math>k\Omega</math> or equivalent impedance to the load in parallel.</li> </ul> <p>Note) If wiring length is long from output module to the load, leakage current by capacity between cables.</p> 
<p>Time trouble in case the load is C-R type timer.</p>	<ul style="list-style-type: none"> <li>Leakage current by surge absorption circuit connected with output elements in parallel</li> </ul> 	<ul style="list-style-type: none"> <li>Run C-R type timer by Relay.</li> <li>Use the timer except C-R type timer.</li> </ul> <p>Note) There is the timer that internal circuit is semi-sine.</p> 
<p>load is not OFF (AC)</p>	<ul style="list-style-type: none"> <li>Circulation current by two different powers</li> </ul>  <ul style="list-style-type: none"> <li>If <math>E1 &lt; E2</math>, circulated</li> <li>If <math>E1</math> is Off(<math>E2</math> On), circulated</li> </ul>	<ul style="list-style-type: none"> <li>Double power --&gt; single power.</li> <li>Connect purified current prevention diode.(as below)</li> </ul>  <p>Note) If load is Relay, it is required to connect reverse voltage absorption diode as dot line on the above figure..</p>

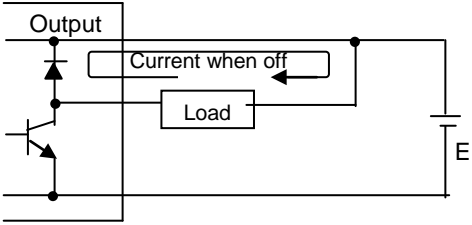
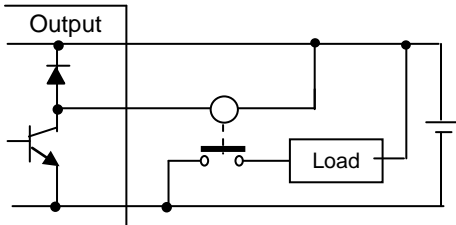
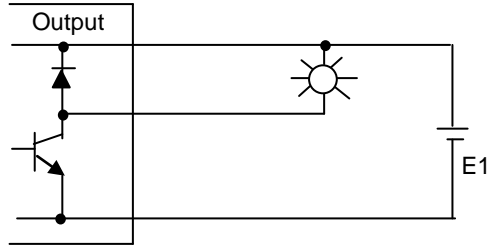
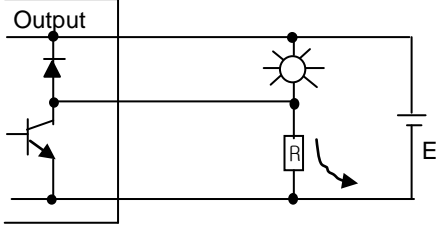
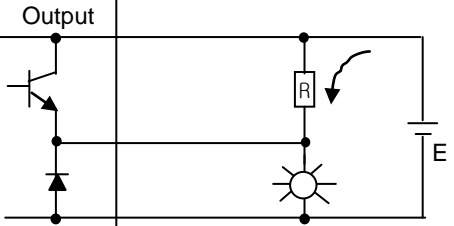
Phenomena	Causes	Measures
<p>Off Response time of load is long abnormally.</p>	<ul style="list-style-type: none"> <li>• Over current when Off [In case of running the inductive load of current such as solenoid (time constant L/R is large) directly by transistor output.</li> </ul>  <ul style="list-style-type: none"> <li>• As the current flows through diode when transistor output OFF, more than 1 second may be delayed according to the load.</li> </ul>	<ul style="list-style-type: none"> <li>• Insert the magnetic contactor that time constant is small and run the load by the contact as below.</li> </ul> 
<p>Output transistor is destroyed.</p>	<p>Inrush current of incandescent light</p>  <p>When light ON, more than 10 times of inrush current may flow.</p>	<ul style="list-style-type: none"> <li>• To control the inrush current, it need to flow 1/3 ~ 1/5 dark current of rated current of incandescent light.</li> </ul>  <p>Sink type transistor output</p>  <p>Source type transistor output</p>

**14.5 Error Code List**

**14.5.1 Error Code during CPU Operation**

Error code	Error cause	Action (restart mode after taking an action)	Operatio n status	LED status	Diagnosi s point
2	Data Bus error	If it occurs repeatedly when power reinput, request service center.	Fail	Blink by the order of total LED.	Power input
3	Data RAM error	If it occurs repeatedly when power reinput, request service center.	Fail	Blink by the order of total LED.	Power input
4	Clock IC(RTC) error	If it occurs repeatedly when power reinput, request service center.	Fail	ERR: On	Power input
6	Program memory error	If it occurs repeatedly when power reinput, request service center.	Fail	ERR: On	Power input
10	USB IC error	If it occurs repeatedly when power reinput, request service center.	Fail	ERR: On	Power input
11	Backup RAM error	If it occurs repeatedly when power reinput, request service center.	Fail	ERR: On	Power input
12	Backup Flash error	If it occurs repeatedly when power reinput, request service center.	Fail	ERR: On	Power input
13	Base information error	If it occurs repeatedly when power reinput, request service center.	Stop	ERR : ON	Power input RUN mode switching
22	Poor Backup Flash program	Reoperate after modifying the backup flash program.	Fail	ERR: On	Reset RUN mode switching
23	Program to execute is abnormal	Start after reloading the program, Change battery if it has a problem. Check the preservation status after program reloading and if error occurs, change the CPU module.	Stop	ERR: On	Reset RUN mode switching
24	I/O parameter error	Start after reloading I/O parameter, Battery change if battery has a problem. Check the preservation status after I/O parameter reloading and if error occurs, change the CPU module.	Stop	ERR: On	Reset RUN mode switching
25	Basic parameter error	Start after reloading Basic parameter, Change battery if it has a problem. Check the preservation status after Basic parameter reloading and if error occurs, change the CPU module.	Stop	ERR: On	Reset RUN mode switching
26	Exceed execution range error	Start after reloading program. If it occurs repeatedly, request service center	Stop	ERR : ON	Reset RUN mode switching
27	Compile error	Start after reloading program. If it occurs repeatedly, request service center	Stop	ERR : ON	Reset RUN mode switching

Error code	Error cause	Action (restart mode after taking an action)	Operation status	LED status	Diagnosis point
30	Module set in parameter and the installed module does not match	After checking the wrong position of slot by XG5000, modify the module or parameter and then restart. Reference flag: module type discord error flag	Stop (Run)	ERR: On (P.S.: On)	RUN mode switching
31	Module falling during operation or additional setup	After checking the position of falling/adding slot by XG5000, modify the installation status of module and then restart (according to parameter). Reference flag: module removable Reference flag: module removable error	Stop (Run)	ERR: On (P.S.: On)	Scan end
32	Fuse cutoff of fuse built-in module during operation	After checking the position of slot where the fuse cutoff occurs by XG5000, change the fuse and then restart (according to parameter) Reference flag: fuse cutoff error flag	Stop (Run)	ERR: On (P.S.: On)	Scan end
33	Data of I/O module does not access normally during operation.	After checking the position of slot where the access error occurs by XG5000, change the module and restart (acc.to parameter). Reference flag: I/O module Read/Write error flag	Stop (Run)	ERR: On (P.S.: On)	Scan end
34	Normal access of special/link module data during operation not available.	After checking the position of slot that access error occurred by XG5000, change the module and restart (acc.to parameter). Reference flag: special/link module interface error	Stop (Run)	ERR: On (P.S.: On)	Scan end
39	Abnormal stop of CPU or malfunction	Abnormal system end by noise or hardware error. 1) If it occurs repeatedly when power reinput, request service center 2) Noise measures	Stop	RUN: On ERR: On	Ordinary time
40	Scan time of program during operation exceeds the scan watchdog time designated by parameter.	After checking the scan watchdog time designated by parameter, modify the parameter or the program and then restart.	Stop	RUN: On ERR: On	In operation
41	Operation error occurs while running the user program.	Remove operation error → reload the program and restart. <Check method> Stop: Check operation error information through XG5000 and modify the program. Run: Refer to F area Error step.	Stop (Run)	ERR : ON (CHK: blink)	While running the program
42	The stack exceeds the normal range while running the program	Restart	Stop	RUN: On ERR: On	While running the program
43	Base double setting error	After checking base setting switch, reset	Stop	ERR: On	Reset RUN mode switching
44	Timer index user error	After reloading a timer index program modification, start	Stop (Run)	RUN: On ERR: On	Scan end
50	Heavy error of	Heavy error detection of external	Stop	ERR: On	Scan end

## Chapter 14 Troubleshooting

Error code	Error cause	Action (restart mode after taking an action)	Operation status	LED status	Diagnosis point
	external device detected by the user program	device Refer to flag to repeat the device and then restart (according to parameter)	(Run)	(P.S.: On)	
55	The number of running standby task exceeds the designated range	If it occurs repeatedly after restart, check the installation environment (if error continues, request service center)	Stop (Run)	ERR: On (P.S.: On)	While running the program
60	E_STOP function executed	After removing error causes which starts E_STOP function in program, power reinput	Stop	RUN: On ERR: On	While running the program
61	Operation error	STOP: after checking the detailed information of operation error by XG5000, modify the program. RUN : refer to error step	Stop (Run)	ERR: On (P.S.: On)	While running the program
500	Data memory backup not possible	If not error in battery, power reinput Remote mode is switched to STOP mode.	Stop	ERR: On	Reset
501	Time data error	If no error in battery, reset the time by XG5000	-	CHK: On	Ordinary time
502	Battery voltage falling	Battery change in the state of power input	-	BAT: On	Ordinary time

### Notes

- 1) If error codes 2 to 13 are displayed, check with your local service center.
- 2) Error code numbers greater than 22 can be checked with XG5000 Error History.

### 14.5.2 Error Code of Program Operation

Code	Error	CPU Status	Causes	Measure
16	Indirect designation/ Index error	According to the Basic Parameter Settings, the CPU will Run or Stop.	Designations are out of range	Designate within the range
17	Group command range setting error		Designations are out of range	Designate within the range
18	0 divider error		Divided by 0 (except RDIV, LDIV)	Don't divide by 0
19	BCD conversion error		The value of the operand is out of the BCD data range.	Designate within the BCD data range
20	File bank setting error		Bank set value is out of range	Set the value within the range
21	Floating point operation error		Floating point operation error	Correct the data
22	Data type conversion error		Data size is different when converting from real to integer numbers	Correct the data
23	BMOV error		Set value is over than 16	Correct the set value

Code	Error	CPU Status	Causes	Measure
24	DECO/ENCO error	According to the Basic Parameter Settings, the CPU will Run or Stop.	Set value is over than 8	Correct the set value
25	DIS/UNI error		The value of N is over 4	Correct the N value
26	Data control error		Over the range	Correct the range
27	Time data error		Time data error	Correct the time data
28	MUX error		Set value error	Correct the set value
29	Data table error		Set value error	Correct the set value
30	SEG error		Number of conversion data is greater than 4	Correct the set value
31	ASCII code error		ASCII data error	Correct the data
32	Positioning setting error axes		Setting axes greater than 3	Correct the number of axes
33	Character string error		Character string instruction error	Correct the instruction
34	SORT error		SORT/DSORT instruction error	Correct the set value
35	FOR nesting error		The number of nesting number is over 16	Correct the program
36	Task number error		The Task number exceeds 96	Correct the task number
37	Device range check error		Out of the device range	Set within the device range
38	P2P data error	Settings of P2P are out of range	Set within the range	
39	Module Configuration error	The module can't be set properly	Set the module properly	

**Notes**

- 1) If the basic parameter is set to "Continue running when error occurs," the program operation error code can be checked using XG5000 system history.
- 2) If "Continue running when error occurs" is removed, it can be checked with XG5000 error history.

## Appendix 1 Flag List

### App.1.1 Special Relay (F) List

Device1	Device2	Type	Variables	Function	Description
F0000		DWORD	_SYS_STATE	Mode and state	Indicates PLC mode and operation state
	F00000	BIT	_RUN	Run	Run state
	F00001	BIT	_STOP	Stop	Stop state
	F00002	BIT	_ERROR	Error	Error state
	F00003	BIT	_DEBUG	Debug	Debug state
	F00004	BIT	_LOCAL_CON	Local control	Local control mode
	F00005	BIT	_MODBUS_CON	Mode bus mode	Mode bus control mode
	F00006	BIT	_REMOTE_CON	Remote mode	Remote control mode
	F00008	BIT	_RUN_EDIT_ST	Editing during RUN	Editing program download during RUN
	F00009	BIT	_RUN_EDIT_CHK	Editing during RUN	Internal edit processing during RUN
	F0000A	BIT	_RUN_EDIT_DONE	Edit done during RUN	Edit is done during RUN
	F0000B	BIT	_RUN_EDIT_END	Edit end during RUN	Edit is ended during RUN
	F0000C	BIT	_CMOD_KEY	Operation mode	Operation mode changed by key
	F0000D	BIT	_CMOD_LPADT	Operation mode	Operation mode changed by local PADT
	F0000E	BIT	_CMOD_RPADT	Operation mode	Operation mode changed by Remote PADT
	F0000F	BIT	_CMOD_RLINK	Operation mode	Operation mode changed by Remote communication module
	F00010	BIT	_FORCE_IN	Forced input	Forced input state
	F00011	BIT	_FORCE_OUT	Forced output	Forced output state
	F00012	BIT	_SKIP_ON	I/O SKIP	I/O SKIP on execution
	F00013	BIT	_EMASK_ON	Error mask	Error mask on execution
	F00014	BIT	_MON_ON	monitor	Monitor on execution
	F00015	BIT	_USTOP_ON	Stop	Stop by Stop function
	F00016	BIT	_ESTOP_ON	EStop	Stop by EStop function
	F00017	BIT	_CONPILE_MODE	Compile	Compile on execution
	F00018	BIT	_INIT_RUN	Initialize	Initialization task on execution
	F0001C	BIT	_PB1	Program Code 1	Program Code 1 selected
	F0001D	BIT	_PB2	Program Code 2	Program Code 2 selected
	F0001E	BIT	_CB1	Compile Code 1	Compile Code 1 selected
	F0001F	BIT	_CB2	Compile Code2	Compile Code 2 selected



## Appendix 1 Flag List

Device1	Device2	Type	Variables	Function	Description
F0002		DWORD	_CNF_ER	System error	Reports heavy error state of system
	F00020	BIT	_CPU_ER	CPU error	CPU configuration error
	F00021	BIT	_IO_TYER	Module Type error	Module Type does not match
	F00022	BIT	_IO_DEER	Module detachment error	Module is detached.
	F00023	BIT	_FUSE_ER	Fuse error	Fuse is cutoff
	F00024	BIT	_IO_RWER	Module I/O error	Module I/O error
	F00025	BIT	_IP_IFER	Module interface error	Special/communication module interface error
	F00026	BIT	_ANNUM_ER	External device error	Detected heavy error in external device
	F00028	BIT	_BPRM_ER	Basic parameter	Basic parameter error
	F00029	BIT	_IOPRM_ER	IO parameter	I/O configuration parameter error
	F0002A	BIT	_SPPRM_ER	Special module parameter	Special module parameter is abnormal
	F0002B	BIT	_CPPRM_ER	Communication module parameter	Communication module parameter is abnormal
	F0002C	BIT	_PGM_ER	Program error	Program error
	F0002D	BIT	_CODE_ER	Code error	Program Code error
	F0002E	BIT	_SWDT_ER	System watchdog	System watchdog operated
	F0002F	BIT	_BASE_POWER_ER	Power error	Base power error
	F00030	BIT	_WDT_ER	Scan watchdog	Scan watchdog operated
F0004		DWORD	_CNF_WAR	System warning	Reports light error state of system
	F00040	BIT	_RTC_ER	RTC error	RTC data error
	F00041	BIT	_DBCK_ER	Backup error	Data backup error
	F00042	BIT	_HBCK_ER	Restart error	Hot restart not possible
	F00043	BIT	_ABSD_ER	Operation shutdown error	Stop by abnormal operation
	F00044	BIT	_TASK_ER	Task collision	Task collision
	F00045	BIT	_BAT_ER	Battery error	Battery error
	F00046	BIT	_ANNUM_WAR	External device error	Detected light error of external device
	F00047	BIT	_LOG_FULL	Memory full	Log memory is full.
	F00048	BIT	_HS_WAR1	High speed link 1	High speed link – parameter 1 error
	F00049	BIT	_HS_WAR2	High speed link 2	High speed link – parameter 2 error
	F0004A	BIT	_HS_WAR3	High speed link 3	High speed link – parameter 3 error
	F0004B	BIT	_HS_WAR4	High speed link 4	High speed link – parameter 4 error
	F0004C	BIT	_HS_WAR5	High speed link 5	High speed link – parameter 5 error
	F0004D	BIT	_HS_WAR6	High speed link 6	High speed link – parameter 6 error
	F0004E	BIT	_HS_WAR7	High speed link 7	High speed link – parameter 7 error
	F0004F	BIT	_HS_WAR8	High speed link 8	High speed link – parameter 8 error
	F00050	BIT	_HS_WAR9	High speed link 9	High speed link – parameter 9 error
	F00051	BIT	_HS_WAR10	High speed link 10	High speed link – parameter 10 error
	F00052	BIT	_HS_WAR11	High speed link 11	High speed link - parameter 11 error

## Appendix 1 Flag List

Device1	Device2	Type	Variables	Function	Description
	F00053	BIT	_HS_WAR12	High speed link 12	High speed link - parameter 12 error
	F00054	BIT	_P2P_WAR1	P2P parameter 1	P2P – parameter 1 error
	F00055	BIT	_P2P_WAR2	P2P parameter 2	P2P – parameter 2 error
	F00056	BIT	_P2P_WAR3	P2P parameter 3	P2P – parameter 3 error
	F00057	BIT	_P2P_WAR4	P2P parameter 4	P2P – parameter 4 error
	F00058	BIT	_P2P_WAR5	P2P parameter 5	P2P – parameter 5 error
	F00059	BIT	_P2P_WAR6	P2P parameter 6	P2P – parameter 6 error
	F0005A	BIT	_P2P_WAR7	P2P parameter 7	P2P – parameter 7 error
	F0005B	BIT	_P2P_WAR8	P2P parameter 8	P2P – parameter 8 error
	F0005C	BIT	_CONSTANT_ER	Constant error	Constant error
F0009		WORD	_USER_F	User contact	Timer used by user
	F00090	BIT	_T20MS	20ms	20ms cycle Clock
	F00091	BIT	_T100MS	100ms	100ms cycle Clock
	F00092	BIT	_T200MS	200ms	200ms cycle Clock
	F00093	BIT	_T1S	1s	1s cycle Clock
	F00094	BIT	_T2S	2s	2s cycle Clock
	F00095	BIT	_T10S	10s	10s cycle Clock
	F00096	BIT	_T20S	20s	20s cycle Clock
	F00097	BIT	_T60S	60s	60s cycle Clock
	F00099	BIT	_ON	Ordinary time On	Always On state Bit
	F0009A	BIT	_OFF	Ordinary time Off	Always Off state Bit
	F0009B	BIT	_1ON	1scan On	First scan ON Bit
	F0009C	BIT	_1OFF	1scan Off	First scan OFF bit
	F0009D	BIT	_STOG	Reversal	Reversal every scan
F0010		WORD	_USER_CLK	User Clock	Clock available for user setting
	F00100	BIT	_USR_CLK0	Setting scan repeat	On/Off as much as set scan Clock 0
	F00101	BIT	_USR_CLK1	Setting scan repeat	On/Off as much as set scan Clock 1
	F00102	BIT	_USR_CLK2	Setting scan repeat	On/Off as much as set scan Clock 2
	F00103	BIT	_USR_CLK3	Setting scan repeat	On/Off as much as set scan Clock 3
	F00104	BIT	_USR_CLK4	Setting scan repeat	On/Off as much as set scan Clock 4
	F00105	BIT	_USR_CLK5	Setting scan repeat	On/Off as much as set scan Clock 5
	F00106	BIT	_USR_CLK6	Setting scan repeat	On/Off as much as set scan Clock 6
	F00107	BIT	_USR_CLK7	Setting scan repeat	On/Off as much as set scan Clock 7

## Appendix 1 Flag List

Device1	Device2	Type	Variables	Function	Description
F0011		WORD	_LOGIC_RESULT	Logic result	Indicates logic results
	F00110	BIT	_LER	operation error	ON during 1 scan in case of operation error
	F00111	BIT	_ZERO	Zero flag	ON when operation result is 0
	F00112	BIT	_CARRY	Carry flag	ON when carry occurs during operation
	F00113	BIT	_ALL_OFF	All output OFF	ON in case that all output is Off
	F00115	BIT	_LER_LATCH	Operation error Latch	Keeps ON during operation error
F0012		WORD	_CMP_RESULT	Comparison result	Indicates the comparison result.
	F00120	BIT	_LT	LT flag	ON in case of "less than"
	F00121	BIT	_LTE	LTE flag	ON in case of "equal or less than"
	F00122	BIT	_EQU	EQU flag	On in case of "equal"
	F00123	BIT	_GT	GT flag	ON in case of "greater than"
	F00124	BIT	_GTE	GTE flag	ON in case of "equal or greater than"
	F00125	BIT	_NEQ	NEQ flag	ON in case of "not equal"
F0013		WORD	_AC_F_CNT	Moment shutdown	Indicates moment shutdown times
F0014		WORD	_FALS_NUM	FALS no.	Indicates FALS no.
F0015		WORD	_PUTGET_ERR0	PUT/GET error 0	Main base Put / Get error
F0016		WORD	_PUTGET_ERR1	PUT/GET error 1	Extended base 1 step Put/Get error
F0017		WORD	_PUTGET_ERR2	PUT/GET error 2	Extended base 2 step Put/Get error
F0018		WORD	_PUTGET_ERR3	PUT/GET error 3	Extended base 3 step Put/Get error
F0019		WORD	_PUTGET_ERR4	PUT/GET error 4	Extended base 4 step Put/Get error
F0020		WORD	_PUTGET_ERR5	PUT/GET error 5	Extended base 5 step Put/Get error
F0021		WORD	_PUTGET_ERR6	PUT/GET error 6	Extended base 6 step Put/Get error
F0022		WORD	_PUTGET_ERR7	PUT/GET error 7	Extended base 7 step Put/Get error
F0023		WORD	_PUTGET_NDR0	PUT/GET end 0	Main base Put/Get end
F0024		WORD	_PUTGET_NDR1	PUT/GET end 1	Extended base 1 step Put/Get end
F0025		WORD	_PUTGET_NDR2	PUT/GET end 2	Extended base 2 step Put/Get end
F0026		WORD	_PUTGET_NDR3	PUT/GET end 3	Extended base 3 step Put/Get end
F0027		WORD	_PUTGET_NDR4	PUT/GET end 4	Extended base 4 step Put/Get end
F0028		WORD	_PUTGET_NDR5	PUT/GET end 5	Extended base 5 step Put/Get end
F0029		WORD	_PUTGET_NDR6	PUT/GET end 6	Extended base 6 step Put/Get end
F0030		WORD	_PUTGET_NDR7	PUT/GET end 7	Extended base 7 step Put/Get end
F0044		WORD	_CPU_TYPE	CPU Type	Indicates information for CPU Type.
F0045		WORD	_CPU_VER	CPU version	Indicates CPU version
F0046		DWORD	_OS_VER	OS version	Indicates OS version
F0048		DWORD	_OS_DATE	OS date	Indicates OS distribution date.
F0050		WORD	_SCAN_MAX	Max. scan time	Indicates max. scan time.
F0051		WORD	_SCAN_MIN	Min. scan time	Indicates min. scan time.
F0052		WORD	_SCAN_CUR	Current scan time	Current scan time

## Appendix 1 Flag List

Device1	Device2	Type	Variables	Function	Description
F0053		WORD	_MON_YEAR	Month/Year	PLC month, year data
F0054		WORD	_TIME_DAY	Time/Day	PLC time, day data
F0055		WORD	_SEC_MIN	Sec/Min	PLC second, minute data
F0056		WORD	_HUND_WK	Hundred year/Weekday	PLC hundred year, weekday data
F0057		WORD	_FPU_INFO	FPU operation result	Fixed decimal operation result
	F00570	BIT	_FPU_LFLAG_I	Incorrect error latch	Latch in case of incorrect error
	F00571	BIT	_FPU_LFLAG_U	Underflow latch	Latch in case of underflow
	F00572	BIT	_FPU_LFLAG_O	Overflow latch	Latch in case of overflow
	F00573	BIT	_FPU_LFLAG_Z	Zero(0) divide latch	Latch in case of zero(0) divide
	F00574	BIT	_FPU_LFLAG_V	Invalid operation latch	Latch in case of invalid operation
	F0057A	BIT	_FPU_FLAG_I	Incorrect error	Reports incorrect error
	F0057B	BIT	_FPU_FLAG_U	Underflow	Reports underflow
	F0057C	BIT	_FPU_FLAG_O	Overflow	Reports overflow
	F0057D	BIT	_FPU_FLAG_Z	Zero divide	Reports in case of zero divide
	F0057E	BIT	_FPU_FLAG_V	Invalid operation	Reports in case of invalid operation
	F0057F	BIT	_FPU_FLAG_E	Irregular input	Reports in case of irregular input
F0058		DWORD	_ERR_STEP	Error step	Saves error step
F0060		DWORD	_REF_COUNT	Refresh	Increase when module Refresh
F0062		DWORD	_REF_OK_CNT	Refresh OK	Increase when module Refresh is normal
F0064		DWORD	_REF_NG_CNT	Refresh NG	Increase when module Refresh is abnormal
F0066		DWORD	_REF_LIM_CNT	Refresh Limit	Increase when module Refresh is abnormal (Time Out)
F0068		DWORD	_REF_ERR_CNT	Refresh Error	Increase when module Refresh is abnormal
F0070		DWORD	_MOD_RD_ERR_CNT	Module Read Error	Increase when reading module 1 word abnormally
F0072		DWORD	_MOD_WR_ERR_CNT	Module Write Error	Increase when module 1 word abnormally
F0074		DWORD	_CA_CNT	Block service	Increase when module block data service
F0076		DWORD	_CA_LIM_CNT	Block service Limit	Increase when block data service is limited
F0078		DWORD	_CA_ERR_CNT	Block service Error	Increase in case of block data service error
F0080		DWORD	_BUF_FULL_CNT	Buffer Full	Increase when CPU internal buffer is full.
F0082		DWORD	_PUT_CNT	Put count	Increase when Put count
F0084		DWORD	_GET_CNT	Get count	Increase when Get count
F0086		DWORD	_KEY	Current key	indicates the current state of local key.
F0088		DWORD	_KEY_PREV	Previous key	indicates the previous state of local key
F0090		WORD	_IO_TYER_N	Mismatch slot	Module Type mismatched slot no.
F0091		WORD	_IO_DEER_N	Detach slot	Module detached slot no.
F0092		WORD	_FUSE_ER_N	Fuse cutoff slot	Fuse cutoff slot no.

## Appendix 1 Flag List

Device1	Device2	Type	Variables	Function	Description
F0093		WORD	_IO_RWER_N	RW error slot	Module read/write error slot no.
F0094		WORD	_IP_IFER_N	IF error slot	Module interface error slot no.
F0096		WORD	_IO_TYER0	Module Type 0 error	Main base module Type error
F0097		WORD	_IO_TYER1	Module Type 1 error	Extended base 1 step module Type error
F0098		WORD	_IO_TYER2	Module Type 2 error	Extended base 2 step module Type error
F0099		WORD	_IO_TYER3	Module Type 3 error	Extended base 3 step module Type error
F0100		WORD	_IO_TYER4	Module Type 4 error	Extended base 4 step module Type error
F0101		WORD	_IO_TYER5	Module Type 5 error	Extended base 5 step module Type error
F0102		WORD	_IO_TYER6	Module Type 6 error	Extended base 6 step module Type error
F0103		WORD	_IO_TYER7	Module Type 7 error	Extended base 7 step module Type error
F0104		WORD	_IO_DEER0	Module detach 0 error	Main base module detach error
F0105		WORD	_IO_DEER1	Module detach 1 error	Extended base 1 step module detach error
F0106		WORD	_IO_DEER2	Module detach 2 error	Extended base 2 step module detach error
F0107		WORD	_IO_DEER3	Module detach 3 error	Extended base 3 step module detach error
F0108		WORD	_IO_DEER4	Module detach 4 error	Extended base 4 step module detach error
F0109		WORD	_IO_DEER5	Module detach 5 error	Extended base 5 step module detach error
F0110		WORD	_IO_DEER6	Module detach 6 error	Extended base 6 step module detach error
F0111		WORD	_IO_DEER7	Module detach 7 error	Extended base 7 step module detach error
F0112		WORD	_FUSE_ER0	Fuse error cutoff 0	Main base fuse cutoff error
F0113		WORD	_FUSE_ER1	Fuse error cutoff 1	Extended base 1 step fuse cutoff error
F0114		WORD	_FUSE_ER2	Fuse error cutoff 2	Extended base 2 step fuse cutoff error
F0115		WORD	_FUSE_ER3	Fuse error cutoff 3	Extended base 3 step fuse cutoff error
F0116		WORD	_FUSE_ER4	Fuse error cutoff 4	Extended base 4 step fuse cutoff error
F0117		WORD	_FUSE_ER5	Fuse error cutoff 5	Extended base 5 step fuse cutoff error
F0118		WORD	_FUSE_ER6	Fuse error cutoff 6	Extended base 6 step fuse cutoff error
F0119		WORD	_FUSE_ER7	Fuse error cutoff 7	Extended base 7 step fuse cutoff error
F0120		WORD	_IO_RWER0	Module error RW 0	Main base module read/write error
F0121		WORD	_IO_RWER1	Module error RW 1	Extended base 1 step module read/write error
F0122		WORD	_IO_RWER2	Module error RW 2	Extended base 2 step module read/write error
F0123		WORD	_IO_RWER3	Module error RW 3	Extended base 3 step module read/write error
F0124		WORD	_IO_RWER4	Module error RW 4	Extended base 4 step module read/write error
F0125		WORD	_IO_RWER5	Module error RW 5	Extended base 5 step module read/write error
F0126		WORD	_IO_RWER6	Module error RW 6	Extended base 6 step module read/write error

## Appendix 1 Flag List

Device1	Device2	Type	Variables	Function	Description
F0127		WORD	_IO_RWER7	Module RW 7 error	Extended base 7 step module read/write error
F0128		WORD	_IO_IFER_0	Module IF 0 error	Main base module interface error
F0129		WORD	_IO_IFER_1	Module IF 1 error	Extended base 1step module interface error
F0130		WORD	_IO_IFER_2	Module IF 2 error	Extended base 2step module interface error
F0131		WORD	_IO_IFER_3	Module IF 3 error	Extended base 3step module interface error
F0132		WORD	_IO_IFER_4	Module IF 4 error	Extended base 4step module interface error
F0133		WORD	_IO_IFER_5	Module IF 5 error	Extended base 5step module interface error
F0134		WORD	_IO_IFER_6	Module IF 6 error	Extended base 6step module interface error
F0135		WORD	_IO_IFER_7	Module IF 7 error	Extended base 7step module interface error
F0136		WORD	_RTC_DATE	RTC date	RTC current date
F0137		WORD	_RTC_WEEK	RTC weekday	RTC current weekday
F0138		DWORD	_RTC_TOD	RTC time	RTC current time (ms unit)
F0140		DWORD	_AC_FAIL_CNT	Power shutdown times	Saves the times of power shutdown
F0142		DWORD	_ERR_HIS_CNT	Error occur times	Saves the times of error occur
F0144		DWORD	_MOD_HIS_CNT	Mode conversion times	Saves the times of mode conversion
F0146		DWORD	_SYS_HIS_CNT	History occur times	Saves the times of system history
F0148		DWORD	_LOG_ROTATE	Log Rotate	Saves log rotate information
F0150		WORD	_BASE_INFO0	Slot information 0	Main base slot information
F0151		WORD	_BASE_INFO1	Slot information 1	Extended base 1step slot information
F0152		WORD	_BASE_INFO2	Slot information 2	Extended base 2step slot information
F0153		WORD	_BASE_INFO3	Slot information 3	Extended base 3step slot information
F0154		WORD	_BASE_INFO4	Slot information 4	Extended base 4step slot information
F0155		WORD	_BASE_INFO5	Slot information 5	Extended base 5step slot information
F0156		WORD	_BASE_INFO6	Slot information 6	Extended base 6step slot information
F0157		WORD	_BASE_INFO7	Slot information 7	Extended base 7step slot information
F0158		WORD	_RBANK_NUM	Use block no.	Current using block no.
F0159		WORD	_RBLOCK_STATE	Flash state	Flash block state
F0164		DWORD	_RBLOCK_ER_FLAG	Flash error	Error during flash NBlock service
F0160		DWORD	_RBLOCK_RD_FLAG	Flash read	ON when reading flash Nblock data
F0162		DWORD	_RBLOCK_WR_FLAG	Flash write	ON when writing flash Nblock data
F0178		DWORD	_OS_VER_PATCH	OS patch version	Indicates OS version to second decimal places.
F09320		BIT	_FUSE_ER_PMT	Setting in case of fuse error	Ignores fuse error
F09321		BIT	_IO_ER_PMT	Setting in case of I/O error	Ignores I/O module error
F09322		BIT	_SP_ER_PMT	Setting in case of special module error	Ignores special module error

## Appendix 1 Flag List

Device1	Device2	Type	Variables	Function	Description
F09323		BIT	_CP_ER_PMT	Setting in case of communication error	Ignores communication module error
F0934		DWORD	_BASE_EMASK_INFO	Base fault mask	Base fault mask information
F0936		DWORD	_BASE_SKIP_INFO	Base Skip	Base skip information
F0938		WORD	_SLOT_EMASK_INFO_0	Slot fault mask	Slot fault mask information (BASE 0)
F0939		WORD	_SLOT_EMASK_INFO_1	Slot fault mask	Slot fault mask information (BASE 1)
F0940		WORD	_SLOT_EMASK_INFO_2	Slot fault mask	Slot fault mask information (BASE 2)
F0941		WORD	_SLOT_EMASK_INFO_3	Slot fault mask	Slot fault mask information (BASE 3)
F0942		WORD	_SLOT_EMASK_INFO_4	Slot fault mask	Slot fault mask information (BASE 4)
F0943		WORD	_SLOT_EMASK_INFO_5	Slot fault mask	Slot fault mask information (BASE 5)
F0944		WORD	_SLOT_EMASK_INFO_6	Slot fault mask	Slot fault mask information (BASE 6)
F0945		WORD	_SLOT_EMASK_INFO_7	Slot fault mask	Slot fault mask information (BASE 7)
F0946		WORD	_SLOT_SKIP_INFO_0	Slot skip	Slot skip information (BASE 0)
F0947		WORD	_SLOT_SKIP_INFO_1	Slot skip	Slot skip information (BASE 1)
F0948		WORD	_SLOT_SKIP_INFO_2	Slot skip	Slot skip information (BASE 2)
F0949		WORD	_SLOT_SKIP_INFO_3	Slot skip	Slot skip information (BASE 3)
F0950		WORD	_SLOT_SKIP_INFO_4	Slot skip	Slot skip information (BASE 4)
F0951		WORD	_SLOT_SKIP_INFO_5	Slot skip	Slot skip information (BASE 5)
F0952		WORD	_SLOT_SKIP_INFO_6	Slot skip	Slot skip information (BASE 6)
F0953		WORD	_SLOT_SKIP_INFO_7	Slot skip	Slot skip information (BASE 7)
F1024		WORD	_USER_WRITE_F	User contact	User contact from Program
	F10240	BIT	_RTC_WR	RTC RW	Write and Read the data to RTC
	F10241	BIT	_SCAN_WR	Scan WR	Scan value initialize
	F10242	BIT	_CHK_ANC_ERR	External heavy error request	Requests heavy error detection from external device
	F10243	BIT	_CHK_ANC_WAR	External light error request	Requests light error detection from external device
F1025		WORD	_USER_STAUS_F	User contact	User contact
	F10250	BIT	_INIT_DONE	Initialize end	Initialization task is done
F1026		WORD	_ANC_ERR	External heavy error information	Indicates heavy error information of external device.
F1027		WORD	_ANC_WAR	External light error warning	Indicates light error information of external device
F1034		WORD	_MON_YEAR_DT	Month/year	Clock information data (month/year)
F1035		WORD	_TIME_DAY_DT	Time/day	Clock information data (time/day)
F1036		WORD	_SEC_MIN_DT	Sec/min	Clock information data (sec/min)
F1037		WORD	_HUND_WK_DT	Hundred year / weekday	Clock information data (hundred year / weekday)
F0176		WORD	_SOE_READ_LOG_CNT	Event count	SOE event count read by user
F0177		WORD	_SOE_READ_LOG_ROTATE	Rotate information	Rotate information of SOE event count read by user
F0954		WORD	_SOE_LOG_CNT	Event count occurred	SOE event count occurred
F0955		WORD	_SOE_LOG_ROTATE	Rotate information	SOE event rotate information

## Appendix 1 Flag List

Device1	Device2	Type	Variables	Function	Description
F09600		BIT	_HS1_ENABLE_STATE	High speed link state	High speed link 1 enable/disable current state
~		BIT	_HSx_ENABLE_STATE	High speed link state	High speed link x enable/disable current state
F0960B		BIT	_HS12_ENABLE_STATE	High speed link state	High speed link 12 enable/disable current state
F10300		BIT	_HS1_REQ	High speed link request	High speed link 1 enable/disable request
~		BIT	_HSx_REQ	High speed link request	High speed link x enable/disable request
F1030B		BIT	_HS12_REQ	High speed link request	High speed link 12 enable/disable request
F10310		BIT	_HS1_REQ_NUM	High speed link setting	High speed link 1 enable/disable setting
~		BIT	_HSx_REQ_NUM	High speed link setting	High speed link x enable/disable setting
F1031B		BIT	_HS12_REQ_NUM	High speed link setting	High speed link 12 enable/disable setting
F09620		BIT	_P2P1_ENABLE_STATE	P2P state	P2P 1 enable/disable current state
~		BIT	_P2Px_ENABLE_STATE	P2P state	P2P x enable/disable current state
F09627		BIT	_P2P8_ENABLE_STATE	P2P state	P2P 8 enable/disable current state
F10320		BIT	_P2P1_REQ	P2P request	P2P 1 enable/disable request
~		BIT	_P2Px_REQ	P2P request	P2P x enable/disable request
F10327		BIT	_P2P8_REQ	P2P request	P2P 8 enable/disable request
F10330		BIT	_P2P1_REQ_NUM	P2P setting	P2P 1 enable/disable setting
~		BIT	_P2Px_REQ_NUM	P2P setting	P2P x enable/disable setting
F10337		BIT	_P2P8_REQ_NUM	P2P setting	P2P 8 enable/disable setting
F0190		WORD	_CYCLE_TASK_SCAN0_MAX	Maximum scan time	Fixed cycle task 0 maximum scan time
F0191		WORD	_CYCLE_TASK_SCAN0_MIN	Minimum scan time	Fixed cycle task 0 minimum scan time
F0192		WORD	_CYCLE_TASK_SCAN0_CUR	Current scan time	Fixed cycle task 0 current scan time
~		WORD	_CYCLE_TASK_SCANx_MAX	Maximum scan time	Fixed cycle task x maximum scan time
~		WORD	_CYCLE_TASK_SCANx_MIN	Minimum scan time	Fixed cycle task x minimum scan time
~		WORD	_CYCLE_TASK_SCANx_CUR	Current scan time	Fixed cycle task x current scan time
F0283		WORD	_CYCLE_TASK_SCAN31_MAX	Maximum scan time	Fixed cycle task 31 maximum scan time
F0284		WORD	_CYCLE_TASK_SCAN31_MIN	Minimum scan time	Fixed cycle task 31 minimum scan time
F0285		WORD	_CYCLE_TASK_SCAN31_CUR	Current scan time	Fixed cycle task 31 current scan time
F10248		BIT	_CYCLE_TASK_SCAN_WR	Scan time initialization	Initialize fixed cycle task's scan time
F996		WORD	_SOCKET_CLOSE_COUNTER[0]	close number each socket	Close number (Socket 0)
F997		WORD	_SOCKET_CLOSE_COUNTER[1]	close number each socket	Close number (Socket 1)
F998		WORD	_SOCKET_CLOSE_COUNTER[2]	close number each socket	Close number (Socket 2)
F999		WORD	_SOCKET_CLOSE_COUNTER[3]	close number each socket	Close number (Socket 3)



## Appendix 1 Flag List

### Appendix 1.2 Communication Relay (L) List

Here describes data link communication relay(L).

[Table 1] Communication Flag List according to High speed link no.(High speed link no. 1 ~ 12)

No.	Keyword	Type	Contents	Description
L000000	_HS1_RLINK	Bit	High speed link parameter 1 normal operation of all station	Indicates normal operation of all station according to parameter set in High speed link, and ON under the condition as below. 1. In case that all station set in parameter is RUN mode and no error, 2. All data block set in parameter is communicated normally, and 3. The parameter set in each station itself is communicated normally. Once RUN_LINK is ON, it keeps ON unless stopped by LINK_DISABLE.
L000001	_HS1_LTRBL	Bit	Abnormal state after _HS1RLINK ON	In the state of _HSmRLINK flag ON, if communication state of the station set in the parameter and data block is as follows, this flag shall be ON. 1. In case that the station set in the parameter is not RUN mode, or 2. There is an error in the station set in the parameter, or 3. The communication state of data block set in the parameter is not good.  LINK TROUBLE shall be ON if the above 1, 2 & 3 conditions occur, and if the condition return to the normal state, it shall be OFF again.
L000020 ~ L00009F	_HS1_STATE[k] (k=000~127)	Bit Array	High speed link parameter 1, k block general state	Indicates the general state of communication information for each data block of setting parameter.  HS1STATE[k]=HS1MOD[k]&_HS1TRX[k]&(~_HSmERR[k])
L000100 ~ L00017F	_HS1_MOD[k] (k=000~127)	Bit Array	High speed link parameter 1, k block station RUN operation mode	Indicates operation mode of station set in k data block of parameter.
L000180 ~ L00025F	_HS1_TRX[k] (k=000~127)	Bit Array	Normal communication with High speed link parameter 1, k block station	Indicates if communication state of k data of parameter is communicated smoothly according to the setting.
L000260 ~ L00033F	_HS1_ERR[k] (k=000~127)	Bit Array	High speed link parameter 1, k block station operation error mode	Indicates if the error occurs in the communication state of k data block of parameter.
L000340 ~ L00041F	_HS1_SETBLOC K[k]	Bit Array	High speed link parameter 1, k block setting	Indicates whether or not to set k data block of parameter.

Notes		
High speed link no.	L area address	Remarks
2	L000500~L00099F	Comparing with High speed link 1 from [Table 1], the flag address of different high speed link station no. is as follows by a simple calculation formula.  * Calculation formula :L area address = L000000 + 500 x (High speed link no. - 1)  In case of using high speed line flag for Program and monitoring, you can use the flag map registered in XG5000 conveniently.
3	L001000~L00149F	
4	L001500~L00199F	
5	L002000~L00249F	
6	L002500~L00299F	
7	L003000~L00349F	
8	L003500~L00399F	
9	L004000~L00449F	
10	L004500~L00499F	
11	L005000~L00549F	

k means block no. and appears 8 words by 16 per 1 word for 128 blocks from 000~127.  
 For example, mode information (\_HS1MOD) appears from block 0 to block 15 for L00010, and block 16~31, 32~47, 48~63, 64~79, 80~95, 96~111, 112~127 information for L00011, L00012, L00013, L00014, L00015, L00016, L00017. Thus, mode information of block no. 55 appears in L000137.

## Appendix 1 Flag List

[Table 2] Communication Flag List according to P2P Service Setting

P2P parameter: 1~8, P2P block : 0~63

No.	Keyword	Type	Contents	Description
L006250	_P2P1_NDR00	Bit	P2P parameter 1, 00 Block service normal end	Indicates P2P parameter 1, 0 Block service normal end
L006251	_P2P1_ERR00	Bit	P2P parameter 1, 00 Block service abnormal end	Indicates P2P parameter 1, 0 Block service abnormal end
L00626	_P2P1_STATUS00	Word	P2P parameter 1, 00 Block service abnormal end error Code	Indicates error code in case of P2P parameter 1, 0 Block service abnormal end
L00627	_P2P1_SVCCNT00	Double word	P2P parameter 1, 00 Block service normal count	Indicates P2P parameter 1, 0 Block service normal count
L00629	_P2P1_ERRCNT00	Double word	P2P parameter 1, 00 Block service abnormal count	Indicates P2P parameter 1, 0 Block service abnormal count
L006310	_P2P1_NDR01	Bit	P2P parameter 1, 01 Block service normal end	P2P parameter 1, 1 Block service normal end
L006311	_P2P1_ERR01	Bit	P2P parameter 1, 01 Block service abnormal end	P2P parameter 1, 1 Block service abnormal end
L00632	_P2P1_STATUS01	Word	P2P parameter 1, 01 Block service abnormal end error Code	Indicates error code in case of P2P parameter 1, 1 Block service abnormal end
L00633	_P2P1_SVCCNT01	Double word	P2P parameter 1, 01 Block service normal count	Indicates P2P parameter 1, 1 Block service normal count
L00635	_P2P1_ERRCNT01	Double word	P2P parameter 1, 01 Block service abnormal count	Indicates P2P parameter 1, 1 Block service abnormal count

**Appendix 1.3 Link Register (N) List**

[Table 1] Link Register List according to P2P no. P2P no. : 1~8, P2P block : 0~63

No.	Keyword	Type	Contents	Description
N00000	_P1B00SN	Word	P2P parameter 1, 00 block another station no.	Saves another station no. of P2P parameter 1, 00 block. In case of using another station no. at XG-PD, it is possible to edit during RUN by using P2PSN command.
N00001 ~ N00004	_P1B00RD1	Device structure	Area device 1 to read P2P parameter 1, 00 block	Saves area device 1 to read P2P parameter 1, 00 block.
N00005	_P1B00RS1	word	Area size 1 to read P2P parameter 1, 00 block	Saves area size 1 to read P2P parameter 1, 00 block.
N00006 ~ N00009	_P1B00RD2	Device structure	Area device 2 to read P2P parameter 1, 00 block	Saves area device 2 to read P2P parameter 1, 00 block.
N00010	_P1B00RS2	word	Area size 2 to read P2P parameter 1, 00 block	Saves area size 2 to read P2P parameter 1, 00 block.
N00011 ~ N00014	_P1B00RD3	Device structure	Area device 3 to read P2P parameter 1, 00 block	Saves area device 3 to read P2P parameter 1, 00 block.
N00015	_P1B00RS3	word	Area size 3 to read P2P parameter 1, 00 block	Saves area size 3 to read P2P parameter 1, 00 block.
N00016 ~ N00019	_P1B00RD4	Device structure	Area device 4 to read P2P parameter 1, 00 block	Saves area device 4 to read P2P parameter 1, 00 block.
N00020	_P1B00RS4	Word	Area size 4 to read P2P parameter 1, 00 block	Saves area size 4 to read P2P parameter 1, 00 block.
N00021 ~ N00024	_P1B00WD1	Device structure	Area device 1 to save P2P parameter 1, 00 block	Saves area device 1 to save P2P parameter 1, 00 block.
N00025	_P1B00WS1	Word	Area size 1 to save P2P parameter 1, 00 block	Saves area size 1 to save P2P parameter 1, 00 block.
N00026 ~ N00029	_P1B00WD2	Device structure	Area device 2 to save P2P parameter 1, 00 block	Saves area device 2 to save P2P parameter 1, 00 block.
N00030	_P1B00WS2	Word	Area size 2 to save P2P parameter 1, 00 block	Saves area size 2 to save P2P parameter 1, 00 block.
N00031 ~ N00034	_P1B00WD3	Device structure	Area device 3 to save P2P parameter 1, 00 block	Saves area device 3 to save P2P parameter 1, 00 block.
N00035	_P1B00WS3	Word	Area size 3 to save P2P parameter 1, 00 block	Saves area size 3 to save P2P parameter 1, 00 block.
N00036 ~ N00039	_P1B00WD4	Device structure	Area device 4 to save P2P parameter 1, 00 block	Saves area device 4 to save P2P parameter 1, 00 block.
N00040	_P1B00WS4	Word	Area size 4 to save P2P parameter 1, 00 block	Saves area size 4 to save P2P parameter 1, 00 block.

## Appendix 1 Flag List

No.	Keyword	Type	Contents	Description
N00041	_P1B01SN	Word	P2P parameter 1, 01 block another station no.	Saves another station no. of P2P parameter 1, 01 block. In case of using another station no. at XG-PD, it is possible to edit during RUN by using P2PSN command.
N00042 ~ N00045	_P1B01RD1	Device structure	Area device 1 to read P2P parameter 1, 01 block	Saves area device 1 to read P2P parameter 1, 01 block.
N00046	_P1B01RS1	Word	Area size 1 to read P2P parameter 1, 01 block	Saves area size 1 to read P2P parameter 1, 01 block.
N00047 ~ N00050	_P1B01RD2	Device structure	Area device 2 to read P2P parameter 1, 01 block	Saves area device 2 to read P2P parameter 1, 01 block.
N00051	_P1B01RS2	Word	Area size 2 to read P2P parameter 1, 01 block	Saves area size 2 to read P2P parameter 1, 01 block.
N00052 ~ N00055	_P1B01RD3	Device structure	Area device 3 to read P2P parameter 1, 01 block	Saves area device 3 to read P2P parameter 1, 01 block.
N00056	_P1B01RS3	Word	Area size 3 to read P2P parameter 1, 01 block	Saves area size 3 to read P2P parameter 1, 01 block.
N00057 ~ N00060	_P1B01RD4	Device structure	Area device 4 to read P2P parameter 1, 01 block	Saves area device 4 to read P2P parameter 1, 01 block.
N00061	_P1B01RS4	Word	Area size 4 to read P2P parameter 1, 01 block	Saves area size 4 to read P2P parameter 1, 01 block.
N00062 ~ N00065	_P1B01WD 1	Device structure	Area device 1 to save P2P parameter 1, 01 block	Saves area device 1 to save P2P parameter 1, 01 block.
N00066	_P1B01WS1	Word	Area size 1 to save P2P parameter 1, 01 block	Saves area size 1 to save P2P parameter 1, 01 block.
N00067 ~ N00070	_P1B01WD 2	Device structure	Area device 2 to save P2P parameter 1, 01 block	Saves area device 2 to save P2P parameter 1, 01 block.
N00071	_P1B01WS2	Word	Area size 2 to save P2P parameter 1, 01 block	Saves area size 2 to save P2P parameter 1, 01 block.
N00072 ~ N00075	_P1B01WD 3	Device structure	Area device 3 to save P2P parameter 1, 01 block	Saves area device 3 to save P2P parameter 1, 01 block.
N00076	_P1B01WS3	Word	Area size 3 to save P2P parameter 1, 01 block	Saves area size 3 to save P2P parameter 1, 01 block.
N00077 ~ N00080	_P1B01WD 4	Device structure	Area device 4 to save P2P parameter 1, 01 block	Saves area device 4 to save P2P parameter 1, 01 block.
N00081	_P1B01WS4	Word	Area size 4 to save P2P parameter 1, 01 block	Saves area size 4 to save P2P parameter 1, 01 block.

### Notes

N area shall be set automatically when setting P2P parameter by using XG-PD and available to modify during RUN by using P2P dedicated command.

N area has a different address classified according to P2P parameter setting no., block index. The area not used by P2P service as address is divided, can be used by internal device.

## Appendix 2 Dimensions (Unit: mm)

### 1) CPU Module

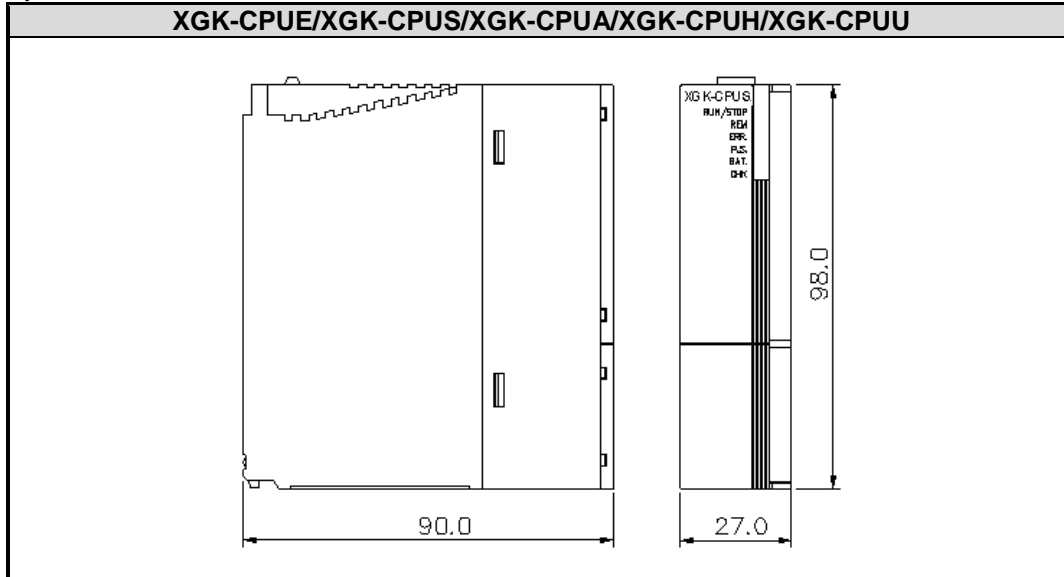

### 2) I/O Module

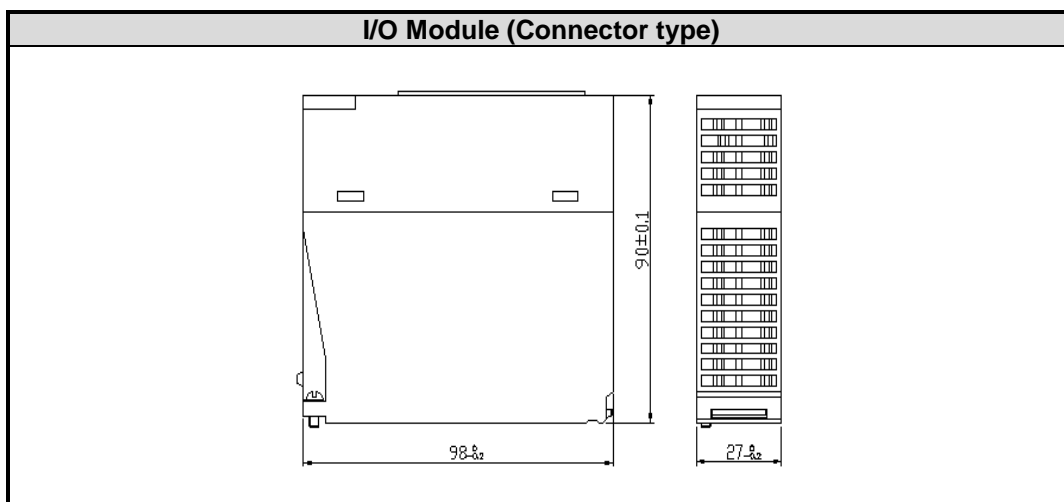
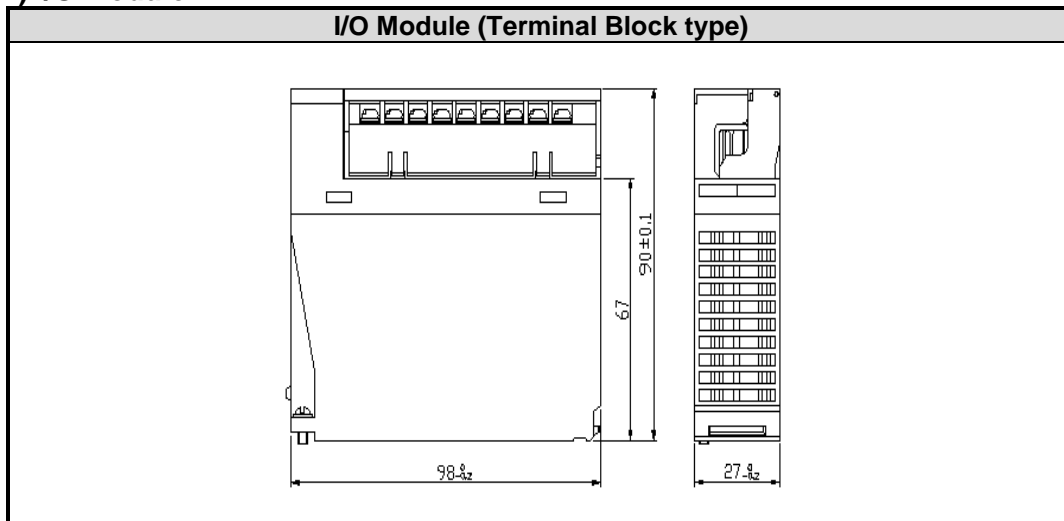

## Appendix 2 Dimensions

### 3) Power Module

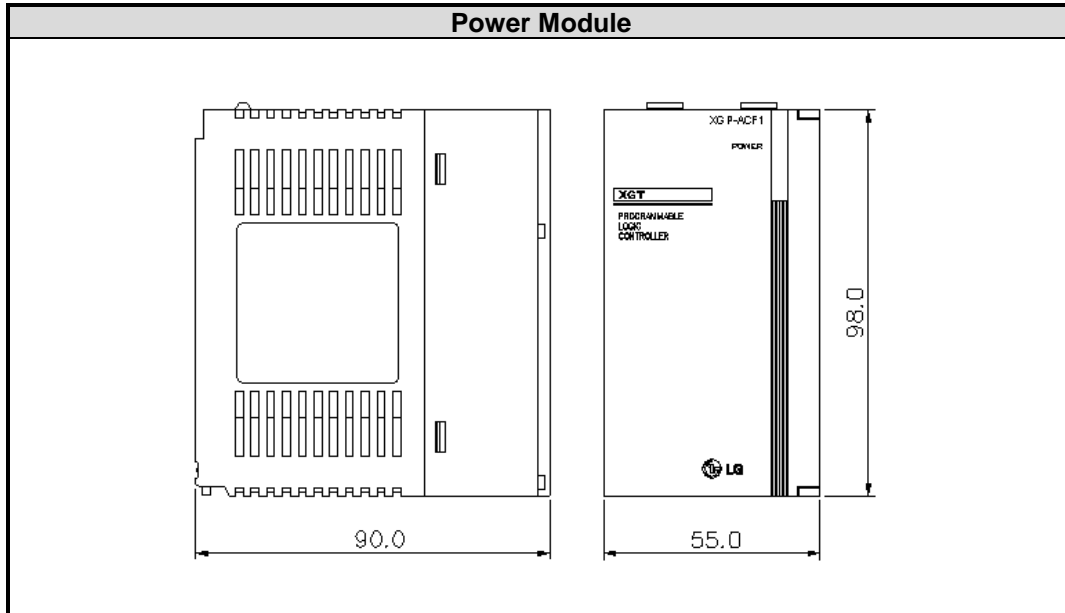

### 4) Main/Expansion Base

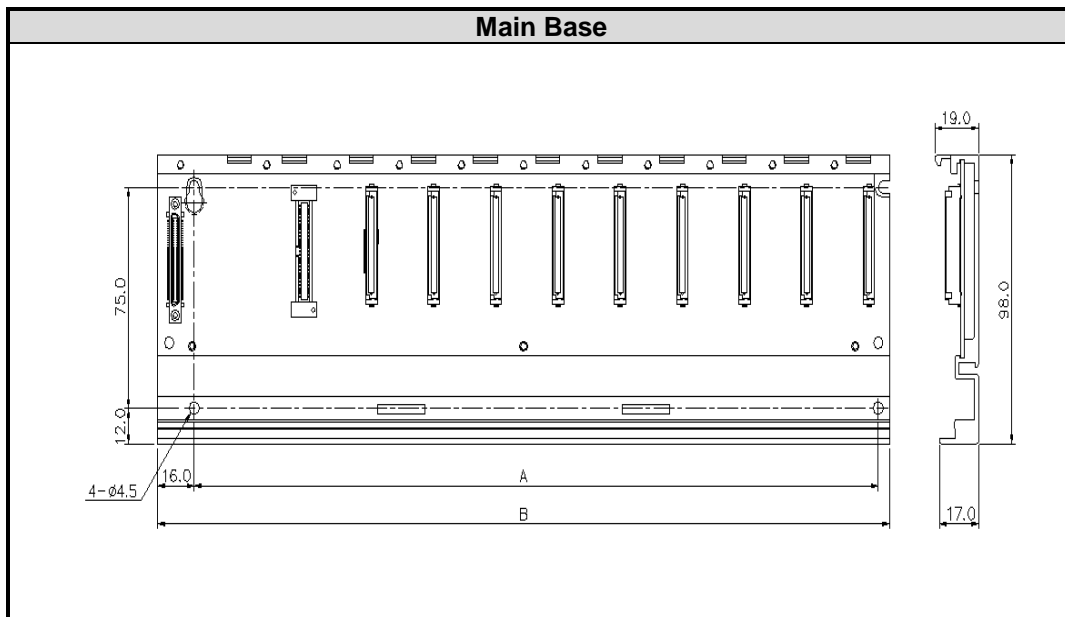

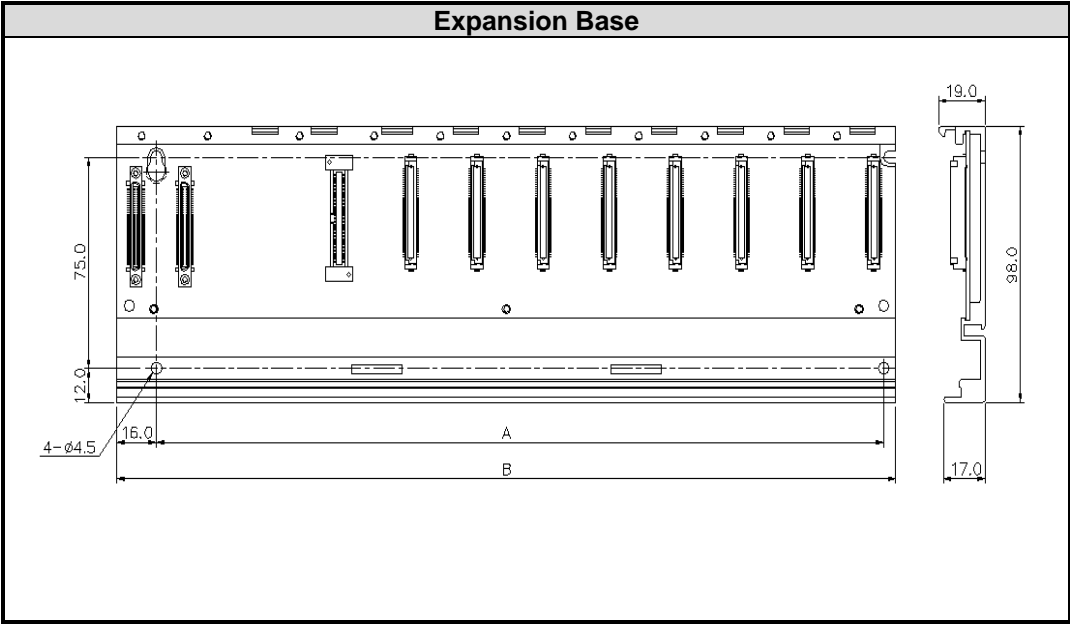

Classification	A	B
XGB-M04A/XGB-E04A	190	210
XGB-M06A/XGB-E06A	244	264
XGB-M08A/XGB-E08A	298	318
XGB-M12A/XGB-E12A	406	426



## Appendix 3 Compatibility with MASTER-K

### App. 3.1 Special Flag Compatibility

#### 1) F Area Relay

MASTER-K		XGK		
Device	Function	Symbol	Device	Function
F0000	RUN mode	_RUN	F0000	RUN Edit mode
F0001	Program mode	_STOP	F0001	Program mode
F0002	Pause mode	_ERROR	F0002	Error mode
F0003	Debug mode	_DEBUG	F0003	Debug mode
F0004	N/A	_LOCAL_CON	F0006	Remote mode
F0005	N/A	_MODBUS_CON	F0006	Remote mode
F0006	Remote mode	_REMOTE_CON	F0006	Remote mode
F0007	User memory setup	-	F0007	N/A
F0008	N/A	_RUN_EDIT_ST	F0008	Editing during RUN
F0009	N/A	_RUN_EDIT_CHK	F0009	Editing during RUN
F000A	User memory operation	_RUN_EDIT_DONE	F000A	Edit done during RUN
F000B	N/A	_RUN_EDIT_END	F000B	Edit end during RUN
F000C	N/A	_CMOD_KEY	F000C	Operation mode change by KEY
F000D	N/A	_CMOD_LPADT	F000D	Operation mode change by PADT
F000E	N/A	_CMOD_RPADT	F000E	Operation mode change by Remote PADT
F000F	STOP command execution	_CMOD_RLINK	F000F	Operation mode change cause by remote communication module
F0010	Ordinary time On	_FORCE_IN	F0010	Forced input
F0011	Ordinary time Off	_FORCE_OUT	F0011	Forced output
F0012	1 Scan On	_SKIP_ON	F0012	I/O Skip execution
F0013	1 Scan Off	_EMASK_ON	F0013	Error mask execution
F0014	Reversal every Scan	_MON_ON	F0014	Monitor execution
		_USTOP_ON	F0015	Stop by Stop Function
		_ESTOP_ON	F0016	Stop by ESTOP Function
		_CONPILE_MODE	F0017	Compile
		_INIT_RUN	F0018	Initialize
F0015 ~ F001F	N/A	-	F0019 ~ F001F	N/A
F001C	N/A	_PB1	F001C	Program Code 1
F001D	N/A	_PB2	F001D	Program Code 2
F001E	N/A	_CB1	F001E	Compile code 1
F001F	N/A	_CB2	F001F	Compile code 2

## Appendix 3 Compatibility with MASTER-K

MASTER-K		XGK		
Device	Function	Symbol	Device	Function
F0020	1 Step RUN	_CPU_ER	F0020	CPU configuration error
F0021	Break Point RUN	_IO_TYER	F0021	Module type mismatch error
F0022	Scan RUN	_IO_DEER	F0022	Module detach error
F0023	Contact value match RUN	_FUSE_ER	F0023	Fuse cutoff error
F0024	Word value match RUN	_IO_RWER	F0024	I/O module read/write error
		_IP_IFER	F0025	Special/communication module interface error
		_ANNUM_ER	F0026	Heavy error detection of external equipment error
		-	F0027	N/A
		_BPRM_ER	F0028	Basic parameter error
		_IOPRM_ER	F0029	I/O configuration parameter error
		_SPPRM_ER	F002A	Special module parameter error
		_CPPRM_ER	F002B	Communication module parameter error
		_PGM_ER	F002C	Program error
		_CODE_ER	F002D	Program Code error
		_SWDT_ER	F002E	System watchdog error
F0025 ~ F002F	N/A	_BASE_POWER_ER	F002F	Base power error
F0030	Heavy error	_WDT_ER	F0030	Scan watchdog
F0031	Light error		F0031	
F0032	WDT error		F0032	
F0033	I/O combination error		F0033	
F0034	Battery voltage error		F0034	
F0035	Fuse error		F0035	
F0036 ~ F0038	N/A		F0036 ~ F0038	
F0039	Backup normal		F0039	
F003A	Clock data error		F003A	
F003B	Program change		F003B	
F003C	Program change error		F003C	
F003D ~ F003F	N/A	-	F003D ~ F003F	N/A
		_RTC_ER	F0040	RTC data error
		_DBCK_ER	F0041	Data backup error
		_HBCK_ER	F0042	Hot restart disabled error
		_ABSD_ER	F0043	Abnormal operation stop
		_TASK_ER	F0044	Task collision
		_BAT_ER	F0045	Battery error
		_ANNUM_ER	F0046	Light error detection of external equipment

## Appendix 3 Compatibility with MASTER-K

MASTER-K		XGK		
Device	Function	Symbol	Device	Function
		_LOG_FULL	F0047	Log memory full warning
		_HS_WAR1	F0048	High speed link parameter 1 error
		_HS_WAR2	F0049	High speed link parameter 2 error
		_HS_WAR3	F0049	High speed link parameter 3 error
		_HS_WAR4	F0049	High speed link parameter 4 error
		_HS_WAR5	F0049	High speed link parameter 5 error
		_HS_WAR6	F0049	High speed link parameter 6 error
		_HS_WAR7	F0049	High speed link parameter 7 error
		_HS_WAR8	F0049	High speed link parameter 8 error
		_HS_WAR9	F0050	High speed link parameter 9 error
		_HS_WAR10	F0051	High speed link parameter 10 error
		_HS_WAR11	F0052	High speed link parameter 11 error
		_HS_WAR12	F0053	High speed link parameter 12 error
		_P2P_WAR1	F0054	P2P parameter 1 error
		_P2P_WAR2	F0055	P2P parameter 2 error
		_P2P_WAR3	F0056	P2P parameter 3 error
		_P2P_WAR4	F0057	P2P parameter 4 error
		_P2P_WAR5	F0058	P2P parameter 5 error
F0040 ~ F005F	N/A	_P2P_WAR6	F0059	P2P parameter 6 error
F0040 ~ F005F	N/A	_P2P_WAR7	F005A	P2P parameter 7 error
F0040 ~ F005F	N/A	_P2P_WAR8	F005B	P2P parameter 8 error
F0040 ~ F005F	N/A	_Constant_ER	F005C	Constant error
F0040 ~ F005F	N/A	-	F005D ~ F005F	N/A
F0060 ~ F006F	Error Code save	-	F0060 ~ F006F	N/A
F0070 ~ F008F	Fuse cutoff save	-	F0070 ~ F008F	N/A
F0090	20ms cycle Clock	_T20MS	F0090	20ms cycle Clock
F0091	100ms cycle Clock	_T100MS	F0091	100ms cycle Clock
F0092	200ms cycle Clock	_T200MS	F0092	200ms cycle Clock
F0093	1s cycle Clock	_T1S	F0093	1s cycle Clock
F0094	2s cycle Clock	_T2S	F0094	2s cycle Clock
F0095	10s cycle Clock	_T10S	F0095	10s cycle Clock
F0096	20s cycle Clock	_T20S	F0096	20s cycle Clock
F0097	60s cycle Clock	_T60S	F0097	60s cycle Clock
		-	F0098	N/A
		_ON	F0099	Ordinary time On
		_OFF	F009A	Ordinary time Off

## Appendix 3 Compatibility with MASTER-K

MASTER-K		XGK		
Device	Function	Symbol	Device	Function
		_1ON	F009B	1 Scan On
		_1OFF	F009C	1 Scan Off
		_STOG	F009D	Reversal every Scan
F0098 ~ F009F		-	F009B ~ F009F	N/A
F0100	User Clock 0		F0100	User Clock 0
F0101	User Clock 1		F0101	User Clock 1
F0102	User Clock 2		F0102	User Clock 2
F0103	User Clock 3		F0103	User Clock 3
F0104	User Clock 4		F0104	User Clock 4
F0105	User Clock 5		F0105	User Clock 5
F0106	User Clock 6		F0106	User Clock 6
F0107	User Clock 7		F0107	User Clock 7
F0108 ~ F010F		-	F0108 ~ F010F	N/A
F0110	Operation error flag	_Ler	F0110	Operation error flag
F0111	Zero flag	_Zero	F0111	Zero flag
F0112	Carry flag	_Carry	F0112	Carry flag
F0113	Full output Off	_All_Off	F0113	Full output Off
F0114	Common RAM R/W error	-	F0114	N/A
F0115	Operation error flag (latch)	_Ler_Latch	F0115	Operation error flag(latch)
F0116 ~ F011F		-	F0116 ~ F011F	N/A
F0120	LT flag	_LT	F0120	LT flag
F0121	LTE flag	_LTE	F0121	LTE flag
F0122	EQU flag	_EQU	F0122	EQU flag
F0123	GT flag	_GT	F0123	GT flag
F0124	GTE flag	_GTE	F0124	GTE flag
F0125	NEQ flag	_NEQ	F0125	NEQ flag
F0126 ~ F012F	N/A	-	F0126 ~ F012F	N/A
F0130~ F013F	AC Down Count	_AC_F_CNT	F0130~ F013F	AC Down Count
F0140~ F014F	FALS no.	_FALS_NUM	F0140~ F014F	FALS no.
F0150~ F015F	PUT/GET error flag	_PUTGET_ERR	F0150~ F030F	PUT/GET error flag
		CPU TYPE	F0440 ~ F044F	CPU TYPE
		CPU VERSION	F0450 ~ F045F	CPU VERSION
		O/S version no.	F0460 ~ F047F	System O/S version no.
F0160~ F049F	N/A	O/S date	F0480 ~ F049F	System O/S DATE

## Appendix 3 Compatibility with MASTER-K

MASTER-K		XGK		
Device	Function	Symbol	Device	Function
F0500~ F050F	Max. Scan time	_SCAN_MAX	F0500~ F050F	Max. Scan time
F0510~ F051F	Min. Scan time	_SCAN_MIN	F0510~ F051F	Min. Scan time
F0520~ F052F	Current Scan time	_SCAN_CUR	F0520~ F052F	Current Scan time
F0530~ F053F	Clock data (year/month)	_YEAR_MON	F0530~ F053F	Clock data (year/month)
F0540~ F054F	Clock data (day/hr)	_DAY_TIME	F0540~ F054F	Clock data(day/hr)
F0550~ F055F	Clock data (min/sec)	_MIN_SEC	F0550~ F055F	Clock data(min/sec)
F0560~ F056F	Clock data (100year/weekday)	_HUND_WK	F0560~ F056F	Clock data(100year/weekday)
		_FPU_LFlag_I	F0570	Incorrect error latch flag
		_FPU_LFlag_U	F0571	Underflow error latch flag
		_FPU_LFlag_O	F0572	Overflow error latch flag
		_FPU_LFlag_Z	F0573	Zero divide error latch flag
		_FPU_LFlag_V	F0574	Invalid operation error latch flag
		-	F0575 ~ F0579	N/A
		_FPU_Flag_I	F057A	Incorrect error flag
		_FPU_Flag_U	F057B	Underflow error flag
		_FPU_Flag_O	F057C	Overflow error flag
		_FPU_Flag_Z	F057D	Zero divide error flag
		_FPU_Flag_V	F057E	Invalid operation error flag
		_FPU_Flag_E	F057F	Irregular value Input error flag
F0570~ F058F	N/A	_ERR_STEP	F0580~ F058F	Error step save
F0590~ F059F	Error step save	-	F0590~ F059F	N/A
F0600~ F060F	FMM detailed error information	_REF_COUNT	F060~F061	Refresh Count
F0610~ F063F	N/A	_REF_OK_CNT	F062~F063	Refresh OK Count
		_REF_NG_CNT	F064~F065	Refresh NG Count
		_REF_LIM_CNT	F066~F067	Refresh Limit Count
		_REF_ERR_CNT	F068~F069	Refresh Error Count
		_MOD_RD_ERR_CNT	F070~F071	MODULE Read Error Count
		_MOD_WR_ERR_CNT	F072~F073	MODULE Write Error Count
		_CA_CNT	F074~F075	Cmd Access Count
		_CA_LIM_CNT	F076~F077	Cmd Access Limit Count
		_CA_ERR_CNT	F078~F079	Cmd Access Error Count
		_BUF_FULL_CNT	F080~F081	Buffer Full Count

### Notes

For flag over F0820 added at XGK, refer to Appendix 1.

---

## Warranty

### 1. Terms of warranty

LSIS provides an 18-month warranty starting from the date of production.

### 2. Range of warranty

For problems within the terms of the warranty, LSIS will replace the entire PLC or repair the defective parts free of charge except for the following cases.

- (1) Problems caused by improper conditions, environment or treatment.
- (2) Problems caused by external devices.
- (3) Problems caused by the user remodeling or repairing the PLC.
- (4) Problems caused by improper use of the product.
- (5) Problems caused by circumstances where the expectations exceed that of the science and technology level when LSIS produced the product.
- (6) Problems caused by natural disaster.

### 3. This warranty is limited to the PLC itself only. It is not valid for the whole system which the PLC is attached to.



**LS values every single customers.**  
**Quality and service come first at LSIS.**  
**Always at your service, standing for our customers.**

<http://eng.lsis.com>

**LS** Industrial Systems

10310000508

■ **HEAD OFFICE**

LS tower, Hogye-dong, Dongan-gu, Anyang-si, Gyeonggi-do 1026-6,  
 Korea <http://eng.lsis.com>  
 Tel : (82-2)2034-4870/Fax : 82-2-2034-4648 e-mail : [cshwang@lsis.com](mailto:cshwang@lsis.com)

■ **LS Industrial Systems Tokyo Office \_ Tokyo, Japan**

Address: 16FL. Higashi-Kan. Akasaka Twin Tower 17-22,  
 Akasaka.Monato-ku Tokyo 107-8470. Japan  
 Tel : 81-3-3582-9128/Fax : 81-3-3582-2667 e-mail : [jschuna@lsis.com](mailto:jschuna@lsis.com)

■ **LS Industrial Systems(ME) FZE \_ Dubai, U.A.E.**

Address : Jafza View Tower Lob 19, Room 205 Along Sheikh Zayed  
 Road Jebel Aali Free Zone Dubai, United Arab Emirates  
 Tel : 971-4-886-5360/Fax : 971-4-886-5361 e-mail : [jungyongl@lsis.com](mailto:jungyongl@lsis.com)

■ **LS Industrial Systems Shanghai Office \_ Shanghai, China**

Address : Room E-G. 12FL Hiamin Empire Plaza. No.726. West.  
 Yan'an Road Shanghai 200050. P.R. China e-mail : [liyong@lsis.com.cn](mailto:liyong@lsis.com.cn)  
 Tel : 86-21-5237-9977(609)/Fax : 89-21-5237-7189

■ **LS Industrial Systems Beijing Office \_ Beijing, China**

Address : B-Tower 17FL. Beijing Global Trade Center B/D. No. 36.  
 East BeisanHuan-Road. DongCheng-District. Beijing 100013. P.R. China  
 Tel : 86-10-5825-6027(666)/Fax : 86-10-5825-6028 e-mail : [xunmi@lsis.com.cn](mailto:xunmi@lsis.com.cn)

■ **LS Industrial Systems Guangzhou Office \_ Guangzhou, China**

Address : Room 1403.14FL. New Poly Tower.  
 2 Zhongshan Liu Road.Guangzhou.P.R China  
 Tel : 86-20-8328-6754/Fax : 86-20-8326-6287 e-mail : [chenxs@lsis.com.cn](mailto:chenxs@lsis.com.cn)

■ **LS Industrial Systems Chengdu Office \_ Chengdu, China**

Address : 12FL. Guodong Buiding. No.52 Jindun  
 Road Chengdu.610041. P.R. China  
 Tel : 86-28-8612-9151(9226)/Fax : 86-28-8612-9236 e-mail : [comysb@lsis.biz](mailto:comysb@lsis.biz)

■ **LS Industrial Systems Qingdao Office \_ Qingdao, China**

Address : YinHe Bldg. 402 Room No. 2P Shandong Road,  
 Qingdao-City,Shandong-province 266071, P.R. China  
 Tel : 86-532-8501-6068/Fax : 86-532-8501-6057 e-mail : [wangzy@lsis.com.cn](mailto:wangzy@lsis.com.cn)

■ **LS Industrial Systems Europe B.V. , Netherlands**

Address : 1st. Floor, Tupolevlaan 48, 1119NZ, Schiphol-Rijk, The Netherlands  
 Tel : +31 (0)20 654 1420/Fax : +31 (0)20 654 1429 e-mail : [junshickp@lsis.biz](mailto:junshickp@lsis.biz)

■ **Wuxi LS Industrial Systems Co., Ltd \_ Wuxi, China**

Address : 102-A. National High & New Tech Industrial Development Area.  
 Wuxi. Jiangsu. 214028. P.R. China  
 Tel : 86-510-8534-6666/Fax : 86-510-8534-4078 e-mail : [caidx@lsis.com.cn](mailto:caidx@lsis.com.cn)

■ **Dalian LS Industrial Systems Co., Ltd. \_ Dalian, China**

Address : No. 15. Liaohehexi 3-Road. Economic and Technical Development zone.  
 Dalian 116600. China  
 Tel : 86-411-273-7777/Fax : 86-411-8730-7560 e-mail : [cuibx@lsis.com.cn](mailto:cuibx@lsis.com.cn)

※ LS Industrial Systems constantly endeavors to improve its product so that information in this manual is subject to change without notice.

© LS Industrial Systems Co., Ltd 2013 All Rights Reserved.

2015. 2